



IFR 6000
XPDR/DME
TCAS/ADS-B/TIS/UAT
TEST SET
Operation Manual



IFR 6000 XPDR/DME TCAS/ADS-B/TIS/UAT TEST SET

Operation Manual

6093 Rev. 503



VIAVI Solutions
1-844-GO-VIAVI
www.viavisolutions.com

Notice

Every effort was made to ensure that the information in this manual was accurate at the time of release. However, information is subject to change without notice, and VIAVI reserves the right to provide an addendum to this manual with information not available at the time that this manual was created.

Copyright/Trademarks

© Copyright 2022 VIAVI Solutions, Inc. All rights reserved. No part of this guide may be reproduced or transmitted, electronically or otherwise, without written permission of the publisher. VIAVI Solutions and the VIAVI logo are trademarks of VIAVI Solutions Inc. (“VIAVI”).

All other trademarks and registered trademarks are the property of their respective owners.

Patent Information

Patented as described at www.viavisolutions.com/patents

Copyright Release

Reproduction and distribution of this guide is authorized for US Government purposes only.

DFARS Statement

If software is for use in the performance of a U.S. Government prime contract or subcontract, software is delivered and licensed as “Commercial Computer Software” as defined in DFAR 252.227-7014 (Feb 2014), or as a “Commercial Item” as defined in FAR 2.101(a) or as “Restricted Computer Software” as defined in FAR 52.227-19 (Dec 2007) or any equivalent agency regulation or contract clause. Use, duplication or disclosure of Software is subject to VIAVI Solutions' standard commercial license terms, and non-DOD Departments and Agencies of the U.S. Government will receive no greater than Restricted Rights as defined in FAR 52.227-19(c)(1-2) (Dec 2007). U.S. Government users will receive no greater than Limited Rights as defined in FAR 52.227-14 (June 1987) or DFAR 252.227-7015 (b)(2) (November 1995), as applicable in any technical data.

Terms and conditions

Specifications, terms, and conditions are subject to change without notice. The provision of hardware, services, and/or software are subject to VIAVI’s standard terms and conditions, available at www.viavisolutions.com/en/terms-and-conditions.

Open Source Disclaimer - IMPORTANT READ CAREFULLY

The IFR 6000 XPDR/DME TCAS/ADS-B/TIS/UAT TEST SET includes third party software licensed under the terms of separate open source software licenses. By using this software you agree to comply with the terms and conditions of the applicable open source software licenses. Software originated by VIAVI is not subject to third party licenses. Terms of the VIAVI Software License different from applicable third party licenses are offered by VIAVI alone.

Declaration of Conformity

VIAVI recommends keeping a copy of the Declaration of Conformity that shipped with the unit with the test set at all times.

Warranty Information

Warranty information for this product is available on the VIAVI website at <https://www.viavisolutions.com/en-us/warranty-information>.

Federal Communications Commission (FCC) Notice

This device complies with part 15 of the FCC Rules. Operation is subject to the following two conditions: (1) This device may not cause harmful interference, and (2) this device must accept any interference received, including interference that may cause undesired operation.

This equipment was tested and found to comply with the limits for a Class A digital device, pursuant to Part 15 of the FCC Rules. These limits are designed to provide reasonable protection against harmful interference when the equipment is operated in a commercial environment. This equipment generates, uses, and can radiate radio frequency energy and, if not installed and used in accordance with the instruction manual, may cause harmful interference to radio communications. Operation of this equipment in a residential area is likely to cause harmful interference, in which case you will be required to correct the interference at your own expense.

The authority to operate this equipment is conditioned by the requirements that no modifications be made to the equipment unless the changes or modifications are expressly approved by VIAVI.



ALERT

- To comply with FCC RF Exposure compliance requirements, a separation distance of at least 20 cm must be maintained between the antenna of this device and all persons.
- This transmitter must not be co-located in conjunction with any other antenna or transmitter.

Industry Canada Requirements

This device complies with Industry Canada's license-exempt RSSs. Operation is subject to the following two conditions: 1) This device may not cause interference; and, 2) This device must accept any interference, including interference that may cause undesired operation of the device.

Le présent appareil est conforme aux CNR d'Industrie Canada applicables aux appareils radio exempts de licence. L'exploitation est autorisée aux deux conditions suivantes: 1) l'appareil ne doit pas produire de brouillage; et, 2) l'utilisateur de l'appareil doit accepter tout brouillage radioélectrique subi, même si le brouillage est susceptible d'en compromettre le fonctionnement.

EU WEEE and Battery Directives

This product, and the batteries used to power the product, should not be disposed of as unsorted municipal waste and should be collected separately and disposed of according to your national regulations.

VIAVI has established a take-back processes in compliance with the EU Waste Electrical and Electronic Equipment (WEEE) Directive, 2012/19/EU, and the EU Battery Directive, 2006/66/EC.

Instructions for returning waste equipment and batteries to VIAVI can be found in the WEEE section of [VIAVI's Standards and Policies web page](#).

If you have questions concerning disposal of your equipment or batteries, contact the VIAVI WEEE Program Management team at WEEE.EMEA@VIAVISolutions.com.

EU REACH

Article 33 of EU REACH regulation (EC) No 1907/2006 requires article suppliers to provide information if a listed Substances of Very High Concern (SVHC) is present in an article above a certain threshold.

For information on the presence of REACH SVHCs in VIAVI products, see the Hazardous Substance Control section of [VIAVI's Standards and Policies web page](#).

EU CE Marking Directives (LV, EMC, RoHS, RE)

This product conforms with all applicable CE marking directives. Please see EU Declaration of Conformity for details.

EMC Directive Compliance

This product was tested and conforms to the EMC Directive, 2014/30/EU for electromagnetic compatibility.

California Proposition 65

California Proposition 65, officially known as the Safe Drinking Water and Toxic Enforcement Act of 1986, was enacted in November 1986 with the aim of protecting individuals in the state of California and the state's drinking water and environment from excessive exposure to chemicals known to the state to cause cancer, birth defects or other reproductive harm.

For the VIAVI position statement on the use of Proposition 65 chemicals in VIAVI products, see the Hazardous Substance Control section of the [VIAVI Standards and Policies web page](#).

Korea Certification

<p>A급 기기 (업무용 방송통신기자재)</p> <p>Class A Equipment (Industrial Broadcasting & Communications Equipment).</p>	<p>이 기기는 업무용(A급) 전자파적합기기로서 판매자 또는 사용자는 이 점을 주의하시기 바라며, 가정외의 지역에서 사용하는 것을 목적으로 합니다.</p> <p>This equipment is Industrial (Class A) electromagnetic wave suitability equipment and seller or user should take notice of it, and this equipment is to be used in the places except for home.</p>
---	---

Ordering information

This manual is a product of the VIAVI Technical Publications Department, issued for use with the IFR 6000 XPDR/DME TCAS/ADS-B/TIS/UAT TEST SET. The PDF format of this manual is available on the VIAVI product website.

Go to: <https://www.viavisolutions.com/en-us/resources/literature-library>

- Type IFR6000 to find the manuals associated with the IFR 6000 XPDR/DME TCAS/ADS-B/TIS/UAT TEST SET.

Contact Information

Contact the Technical Assistance Center (TAC) for technical support or with any questions regarding this or other VIAVI products.

- Phone: 1-844-GO-VIAVI
- Email: Techsupport.Avcomm@viavisolutions.com

For the latest TAC information, go to:

<https://www.viavisolutions.com/en-us/support/technical-product-support/technical-assistance>

SAFETY FIRST: TO ALL SERVICE PERSONNEL

REFER ALL SERVICING OF UNIT TO QUALIFIED TECHNICAL PERSONNEL.

WARNING: USING THIS EQUIPMENT IN A MANNER NOT SPECIFIED BY THE ACCOMPANYING DOCUMENTATION MAY IMPAIR THE SAFETY PROTECTION PROVIDED BY THE EQUIPMENT.

CASE, COVER OR PANEL REMOVAL

Opening the Case Assembly exposes the technician to electrical hazards that can result in electrical shock or equipment damage.

SAFETY IDENTIFICATION IN TECHNICAL MANUAL

This manual uses the following terms to draw attention to possible safety hazards, that may exist when operating or servicing this equipment.

CAUTION: THIS TERM IDENTIFIES CONDITIONS OR ACTIVITIES THAT, IF IGNORED, CAN RESULT IN EQUIPMENT OR PROPERTY DAMAGE (E.G., FIRE).

WARNING: THIS TERM IDENTIFIES CONDITIONS OR ACTIVITIES THAT, IF IGNORED, CAN RESULT IN PERSONAL INJURY OR DEATH.

SAFETY SYMBOLS IN MANUALS AND ON UNITS



CAUTION: Refer to accompanying documents. (This symbol refers to specific CAUTIONS represented on the unit and clarified in the text.)



AC OR DC TERMINAL: Terminal that may supply or be supplied with ac or dc voltage.



DC TERMINAL: Terminal that may supply or be supplied with dc voltage.



AC TERMINAL: Terminal that may supply or be supplied with ac or alternating voltage.

EQUIPMENT GROUNDING PRECAUTION

Improper grounding of equipment can result in electrical shock.

USE OF PROBES

Check specifications for the maximum voltage, current and power ratings of any connector on the Test Set before connecting it with a probe from a terminal device. Be sure the terminal device performs within these specifications before using it for measurement, to prevent electrical shock or damage to the equipment.

POWER CORDS

Power cords must not be frayed, broken nor expose bare wiring when operating this equipment.

USE RECOMMENDED FUSES ONLY

Use only fuses specifically recommended for the equipment at the specified current and voltage ratings.

WARNING: THE IFR 6000 USES A LITHIUM-ION BATTERY PACK. THE FOLLOWING WARNINGS CONCERNING LITHIUM-ION BATTERIES MUST BE HEEDED:

- **DO NOT RECHARGE OUTSIDE THE IFR 6000.**
- **DO NOT CRUSH, INCINERATE OR DISPOSE OF IN NORMAL WASTE.**
- **DO NOT SHORT CIRCUIT OR FORCE DISCHARGE AS THIS MIGHT CAUSE THE BATTERY TO VENT, OVERHEAT OR EXPLODE.**

TABLE OF CONTENTS

Title	Chapter/Section
Title Page / Copyright Page	
Statements	
Safety Page	
Declaration of Conformity	
Table of Contents	
Introduction	
Service Upon Receipt of Material	
Chapter 1	
Section 1 - Description and Quick Start	1-1
Section 2 - Operation	1-2
Section 3 - Specifications	1-3
Section 4 - Shipping	1-4
Section 5 - Storage	1-5
Appendix A - Connector Pin-Out Tables	
Appendix B - Metric/British Imperial Conversion Table with Nautical Distance Conversions	
Appendix C - Factory/Power Up Presets	
Appendix D - Abbreviations	
Appendix E - Breakout Box	
Appendix F - Transponder Configurations	
Appendix G - Mode S Address Blocks (Product Specific List)	
Appendix H - Mode S Address Blocks (Complete List)	
Appendix I - Signal Formats	
Appendix J - Standard Accessories	
Appendix K - Target Acquisition Time Probability Table	
Index	
Battery/Fuse Instructions	

THIS PAGE INTENTIONALLY LEFT BLANK.

INTRODUCTION

This manual contains operating instructions for the IFR 6000. It is strongly recommended that personnel be thoroughly familiar with the contents of this manual before attempting to operate this equipment.

Refer all servicing of unit to qualified technical personnel.

ORGANIZATION

This manual is divided into the following Chapters and Sections:

CHAPTER 1 - OPERATION

Section 1 - DESCRIPTION and Quick Start (for operators familiar with avionics systems)

Section 2 - OPERATION (installation, description of controls, connectors and indicators, performance evaluation and operating procedures)

Section 3 - SPECIFICATIONS

Section 4 - SHIPPING

Section 5 - STORAGE

THIS PAGE INTENTIONALLY LEFT BLANK.

CHAPTER ONE
IFR 6000 XPDR/DME/TCAS/ADS-B/TIS/TIS-B/UAT TEST SET
OPERATION MANUAL
TABLE OF CONTENTS

Title	Chapter/Section/Subject	Page
SECTION 1 - DESCRIPTION		1-1
1. General Description and Capabilities	1-1-1	1
1.1 Description	1-1-1	1
1.2 Functional Capabilities	1-1-1	1
1.3 Regulatory Responsibilities	1-1-1	2
2. Quick Start	1-1-2	1
2.1 Controls	1-1-2	1
2.2 General Setup	1-1-2	2
2.3 XPDR Setup and Testing Antenna	1-1-2	2
2.4 XPDR Setup and Testing Direct Connect	1-1-2	4
2.5 XPDR Setup and Testing Antenna Coupler Connect	1-1-2	5
2.6 XPDR Testing	1-1-2	6
2.6.1 ADS-B/GICB Testing	1-1-2	7
2.6.2 ADS-B MON	1-1-2	7
2.6.3 ADS-B GEN	1-1-2	8
2.6.4 GICB	1-1-2	9
2.6.5 Advisory Circular	1-1-2	9
2.7 DME Setup Antenna	1-1-2	10
2.8 DME Setup Direct Connect	1-1-2	10
2.9 DME Setup Antenna Coupler Connect	1-1-2	11
2.10 DME Testing	1-1-2	11
2.11 TCAS (TAS) Setup Antenna	1-1-2	12
2.12 TCAS (TAS) Testing	1-1-2	13
2.13 TIS Setup Antenna	1-1-2	14
2.14 TIS Setup Direct Connect	1-1-2	15
2.15 TIS Testing	1-1-2	15
2.16 UAT MON	1-1-2	16
2.17 UAT FIS-B GEN	1-1-2	18
2.18 UAT TIS-B GEN	1-1-2	19
2.19 UAT ADS-B GEN	1-1-2	20
SECTION 2 - OPERATION		1-2
1. Installation	1-2-1	1
1.1 General	1-2-1	1
1.2 Battery Operation	1-2-1	1
1.3 Battery Charging	1-2-1	1
1.4 Safety Precautions	1-2-1	1
1.4.1 Complying with Instructions	1-2-1	1
1.4.2 Grounding Power Cord	1-2-1	1
1.4.3 Operating Safety	1-2-1	1
1.5 AC Power Requirements	1-2-1	2
1.6 Battery Recharging	1-2-1	2
1.7 External Cleaning	1-2-1	3
2. Controls, Connectors and Indicators	1-2-2	1
3. Performance Evaluation	1-2-3	1
3.1 General	1-2-3	1
3.2 Self-Test	1-2-3	1
3.3 Calibration	1-2-3	2
3.4 RS-232 Self-Test	1-2-3	2
3.5 Manual Self-Test	1-2-3	2

TABLE OF CONTENTS (cont)

Title	Chapter/Section/Subject	Page
SECTION 2 – OPERATION (cont)		1-2
4. Operating Procedures	1-2-4	1
4.1 General	1-2-4	1
4.2 Start-Up	1-2-4	2
4.3 Set-up General	1-2-4	2
4.4 XPDR (Transponder)	1-2-4	2
4.4.1 Configurations	1-2-4	2
4.4.2 Setup	1-2-4	3
4.4.3 Auto Test	1-2-4	8
4.4.4 Test List	1-2-4	10
4.4.5 Altitude Encoder	1-2-4	28
4.4.6 Direct Connect Procedure	1-2-4	29
4.4.7 Antenna Coupler Procedure	1-2-4	29
4.4.8 "Over the Air" Ground Test	1-2-4	30
4.4.9 "Over the Air" Simulated Altitude Test	1-2-4	30
4.5 ADS-B General	1-2-4	31
4.5.1 ADS-B/GICB Modes	1-2-4	31
4.5.2 Setup ADS-B	1-2-4	32
4.5.3 ADS-B/GICB MAIN	1-2-4	34
4.5.4 ADS-B MON	1-2-4	34
4.5.5 Advisory Circular	1-2-4	57
4.5.6 ADS-B GEN	1-2-4	63
4.5.7 GICB General	1-2-4	77
4.5.8 GICB Mode	1-2-4	77
4.6 UAT General	1-2-4	102
4.6.1 UAT Setup	1-2-4	102
4.6.2 FIS-B GEN	1-2-4	103
4.6.3 TIS-B GEN	1-2-4	107
4.6.4 TIS-B GEN Data	1-2-4	109
4.6.5 ADS-B GEN	1-2-4	109
4.6.6 ADS-B GEN Data	1-2-4	112
4.6.7 ADS-B MON	1-2-4	112
4.6.8 GPS Status	1-2-4	123
4.7 DME	1-2-4	124
4.7.1 Setup	1-2-4	125
4.8 TCAS Mode	1-2-4	128
4.8.1 TCAS Operation Concept	1-2-4	128
4.8.2 TCAS (TAS) Testing	1-2-4	131
4.8.3 TCAS Setup	1-2-4	131
4.8.4 TCAS Screen	1-2-4	135
4.8.5 Setup-Scenario Data Screen	1-2-4	138
4.8.6 Monitor Screens	1-2-4	140
4.5.6.1 Surveillance Monitor	1-2-4	140
4.5.6.2 Broadcast Monitor	1-2-4	142
4.5.6.3 ATCRBS	1-2-4	144
4.8.7 Recommended Test Procedure	1-2-4	147
4.9 TIS General	1-2-4	149
4.9.1 TIS Mode	1-2-4	149
4.9.2 TIS Setup	1-2-4	149
4.10 Directional Antenna	1-2-4	153
4.11 Breakout Box	1-2-4	157

TABLE OF CONTENTS (cont)

Title	Chapter/Section/Subject	Page
SECTION 3 - SPECIFICATIONS	1-3	
SECTION 4 - SHIPPING	1-4	
1. Shipping Test Sets	1-4-1	1
1.1 Information	1-4-1	1
1.2 Repacking Procedure	1-4-1	1
SECTION 5 - STORAGE	1-5	

THIS PAGE INTENTIONALLY LEFT BLANK.

LIST OF ILLUSTRATIONS

Title	Chapter/Section/Subject	Page
Ramp Testing	1-1-2	3
Battery Recharging	1-2-1	2
IFR 6000 Front Panel	1-2-2	1
Directional Antenna	1-2-2	6
Breakout Box, Front View	1-2-2	6
Breakout Box, Top View	1-2-2	7
Breakout Box, Bottom View	1-2-2	7
TCAS Protection Volume	1-2-4	35
Typical TCAS II Display	1-2-4	37
Recommended Test Locations	1-2-4	54
TIS Operation Flow Chart	1-2-4	131
Suggested Layout to Reduce Multipath Errors	1-2-4	153
Ramp Testing	1-2-4	154
Repacking Procedure	1-4-1	1

THIS PAGE INTENTIONALLY LEFT BLANK.

LIST OF TABLES

Title	Chapter/Section/Subject	Page
Test Identifier Symbols	1-2-4	9
Common Usage GICB BDS	1-2-4	25
Protection Volume Parameters Versus Altitude	1-2-4	35
SL: Field Valid Data	1-2-4	40
CA: Field Valid Data	1-2-4	41
RI: Field (Acquisition) Valid Data	1-2-4	41
RI: Field (Tracking) Valid Data	1-2-4	41
RAC: Field Valid Data	1-2-4	41
ARA: Field Valid Data	1-2-4	42
CVC: Field Display Data	1-2-4	48
VRC: Field Display Data	1-2-4	48
CHC: Field Display Data	1-2-4	48
HRC: Field Display Data	1-2-4	48
ESB: Field Display Data	1-2-4	49
ARA=Field Valid Data	1-2-4	50
RAC=Field Valid Data	1-2-4	51
“TYPE” Subfield Code Definitions (DF=17 or 18)	1-2-4	61
“MOVEMENT” Subfield in ADS-B Surface Position Messages	1-2-4	67
Lateral Axis GPS Antenna Offset Encoding	1-2-4	68
Longitudinal Axis GPS Antenna Offset Encoding	1-2-4	68
GICB Supported BDS Registers	1-2-4	104

THIS PAGE INTENTIONALLY LEFT BLANK.

SERVICE UPON RECEIPT OF MATERIAL

Unpacking

Special-design packing material inside this shipping carton provides maximum protection for the IFR 6000. Avoid damaging the carton and packing material during equipment unpacking. Use the following steps for unpacking the IFR 6000.

- Cut and remove the sealing tape on the carton top and open the carton.
- Grasp the IFR 6000 transit case firmly, while restraining the shipping carton, and lift the equipment and packing material vertically.
- Place the IFR 6000 transit case and end cap packing on a suitable flat, clean and dry surface.
- Remove the protective plastic bag from the IFR 6000 transit case.
- Place protective plastic bag and end cap packing material inside shipping carton.
- Store the shipping carton for future use should the IFR 6000 need to be returned.

Checking Unpacked Equipment

- Inspect the equipment for damage incurred during shipment. If the equipment has been damaged, report the damage to VIAVI.
- Check the equipment against the packing slip to see if the shipment is complete. Report all discrepancies to VIAVI.



IFR 6000 with Standard Accessories

DESCRIPTION	PART NUMBER	QTY
IFR 6000	72422	1
Power Supply	67366	1
Antenna	112684	1
Breakout Box	64580	1
Antenna Shield	64749	1
12 IN. Coaxial Cable (Antenna)	62401	1
72 IN. Coaxial Cable (Antenna)	112830	1
5 A Fuse	56080	1
Transit Case	10241	1
Power Cord (US only)	62302	1
POWER CORD (EUROPEAN)	64020	1
Operation Manual (CD)	6093	1
Getting Started Manual (paper)	6096	1



Antenna Coupler and Cable

OPTIONAL ACCESSORIES	PART NUMBER	QTY
Desk Top Stand	63656	1
Tripod	67474	1
Tripod, Dolly, Stand	82553	1
25 ft TNC/TNC COAXIAL CABLE	62462	1
50 ft TNC/TNC COAXIAL CABLE	86336	1
UC-584 Dual Antenna Coupler Kit	112349	1
UC-584 Single Antenna Coupler Kit	112350	1
12 IN. COAXIAL CABLE (GPS)	112831	1
72 IN. Coaxial CABLE (GPS)	112837	1
Maintenance Manual (CD)	6095	1
Remote Commands Manual (CD)	112286	1

1-SERVICE UPON RECEIPT OF MATERIALS

THIS PAGE INTENTIONALLY LEFT BLANK.

SECTION 1 - DESCRIPTION

1. GENERAL DESCRIPTION AND CAPABILITIES

1.1 DESCRIPTION

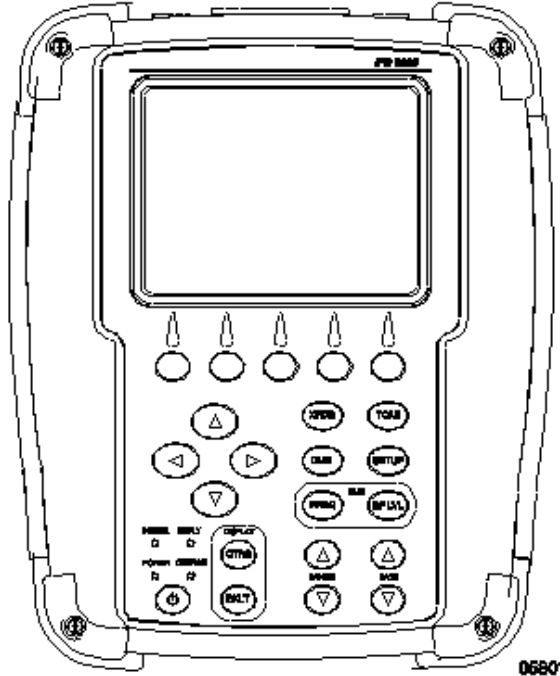

The IFR 6000 is a precision simulator that enables one person to functionality test airborne transponder (XPDR) modes A/C/S, distance measuring equipment (DME) systems, TCAS I and II, ADS-B equipped transponders and 1090 MHz emitters, and Universal Access Transceiver (UAT).

The Test Set contains built-in signal generators and modulators for XPDR and selected DME frequencies. For ramp operation, the RF output is coupled to the airborne equipment by a lightweight directional antenna that may be mounted on the Test Set or tripod. For bench operation, coaxial cables are required between the Test Set and UUT.

1.2 FUNCTIONAL CAPABILITIES

The IFR 6000 has the following features and capabilities:

Functional Modes:

XPDR, DME, TCAS I and II, ADS-B MON, ADS-B GICB, ADS-B GEN, TIS, and UAT.

- XPDR Auto Test provides a full FAR Part 43 Appendix F test. All normal user verified parameters are displayed on one screen.
- Parametric tests include ERP, MTL, Pulse Widths and Spacings.
- Separate screens for display of primary Elementary and Enhanced Surveillance parameters.
- Predetermined user selectable XPDR config files allow different classes of ATRBS and Mode S transponder to be tested.
- Altitude Encoder screen for monitoring encoding altimeter grey code.
- XPDR and DME Setup screens provide user defined operation parameters.
- Single DME test screen provides control over DME Frequency/Channel, Range, Rate, RF level, % Reply, Squitter, Ident and Echo. UUT frequency, ERP, PRF P1/P2 width and Spacing are also displayed.
- LCD Display with automatic light sensing illumination control
- Internal Battery allowing six hours operation before recharge.
- Automatic power shutdown after approximately 15 minutes of non-use when ac power is not connected.
- Compact size and lightweight for one person operation.

1.3 REGULATORY RESPONSIBILITIES

Effective April 6, 1987, the Federal Aviation Administration (FAA) has required certain tests be performed on transponders, both conventional ATRBS and Mode S. In preparation for the installation of new air traffic control radar facilities, the FAA required new measurements to be performed on existing transponders and instituted required tests for Mode S transponders. FAR (Federal Aviation Regulations) Part 43, Maintenance, Preventive Maintenance, Rebuilding and Alteration section has been modified to reflect current technologies and improvements. VIAVI has met all FAA requirements and recommends that the user of this type of equipment review the appropriate FAR or contact the manufacturer of their particular model of transponder to ensure that proper procedures are followed.

Eurocontrol and the JAA have also incorporated new regulations for Mode S Elementary and Enhanced Surveillance. These requirements include Selective Identifiers for high-density traffic areas and became mandatory in May, 2003 for Elementary Surveillance and March, 2005 for Enhanced Surveillance.

The IFR 6000 has the capability to thoroughly test these new functions to comply with upcoming requirements. For further information regarding these requirements, visit www.eurocontrol.int/.

2. QUICK START

The Quick Start is for operators who are familiar with avionics systems/test equipment and want to use the IFR 6000 before reading the complete Operation Manual. Refer to para 1-2-4.1 for detailed operation instructions.

2.1 CONTROLS



 Turns Test Set ON or OFF.

POWER: Indicator illuminates when Test Set is operational.

CHARGE: Indicator illuminates to show battery charge status;

Yellow	Charging
Flashing Yellow	Faulty battery
Green	Fully charged

NOTE: Operates when External DC Power Supply is connected.

INTERR: Indicator illuminates when Test Set is interrogating (XPDR Mode) or receiving interrogations (DME Mode).

REPLY: Indicator illuminates when Test Set is receiving replies (XPDR Mode) or replying to interrogations (DME Mode).

CTRS: Adjusts display contrast.

BKLT: Adjusts display backlight.

RANGE ▲: Increases DME range and TCAS start range.

RANGE ▼: Decreases DME range and TCAS start range.

RATE ▲: Increases DME and TCAS rate.

RATE ▼: Decreases DME and TCAS rate.

FREQ: Frequency/channel selection for DME Mode only.

RF LVL: RF level setting for DME Mode only.

XPDR: Selects XPDR, ADS-B/GICB, UAT and ALT ENCODER screens.

DME: Selects DME screen.

TCAS: Selects TCAS and TIS screens.

SETUP: Displays the setup screens associated with the selected functional mode.

SOFT KEYS: Five Application dependent keys provide test specific information and movement between test screens.



DATA KEYS

▲ DATA KEY: Selects or slews data.

▼ DATA KEY: Selects or slews data.

◀ DATA KEY: Moves the cursor to the left in a data field.

▶ DATA KEY: Moves the cursor to the right in a data field.



2.2 GENERAL SETUP

STEP	PROCEDURE
------	-----------

1. Power Up: Press the POWER Key to power the Test Set On.
2. Press SETUP Control Key to display setup screens. Continue pressing SETUP Control Key to cycle to SETUP-GENERAL Screen. Use NEXT PARAM and PREV PARAM Soft Keys to select each parameter.

SETUP - GENERAL		BAT 2.5 Hr	
PWR DOWN : 10 mins			
ERP UNITS : dBm		UNITS : METERS	
REMOTE OPERATION : RS232			
ANTENNA TYPE : 7005-5840-500			
PREV PARAM	NEXT PARAM	H/W TOOLS	INFO

3. Select PWR: Set to preferred power down timeout.
4. Select ERP UNITS: Set to preferred ERP units.
5. Select UNITS: Set to preferred units.

To change default antenna gain values:

STEP	PROCEDURE
------	-----------

1. Select ANTENNA TYPE: Select the appropriate type based on the part number of the antenna.
 Selections are:
 7005-5840-500
 91771
 112684 with GPS
NOTE: There are three types of antenna available. 7005-5840-500 antenna type has a different set of default gain values. The ANTENNA TYPE setting only needs to be changed when installing an antenna that does not match the current setting.
2. Press INFO soft key.
3. Press RECALL DEFAULT soft key.

2.3 XPDR SETUP AND TESTING ANTENNA

STEP	PROCEDURE
------	-----------

1. Mount Directional Antenna on Test Set and position friction hinge so Directional Antenna is as shown. Connect short RF coaxial cable (PN: 62401) between Antenna Connector and Test Set ANT Connector. If UAT Option is available, connect the short RF coaxial cable (PN: 112831) between the Antenna GPS Connector and the Test Set GPS Connector.



2. Position Test Set ≤ 50 ft (15.24 m) from and in line of sight with top/bottom antenna.
3. Power On Aircraft and configure aircraft for weight off wheels.
4. Press POWER Key to power up the Test Set.

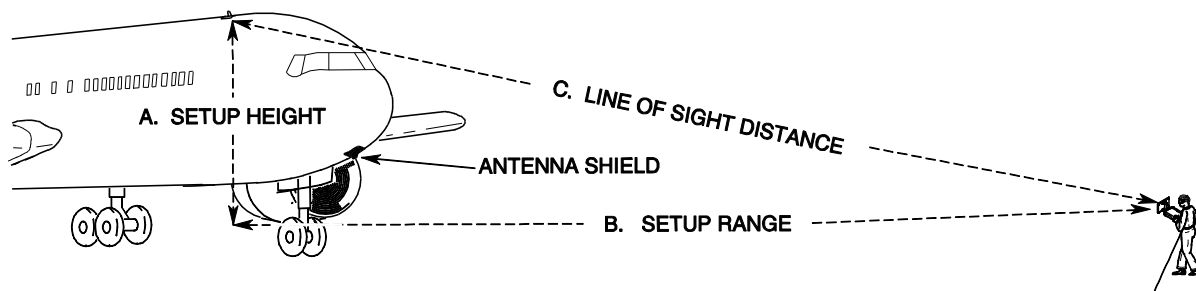

TESTING TOP ANTENNA

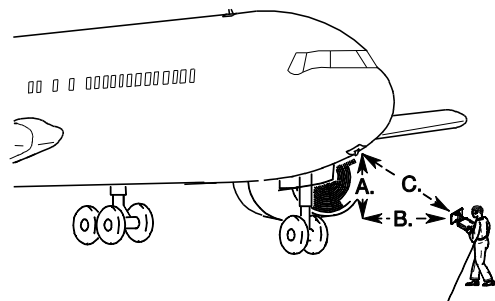

TESTING BOTTOM ANTENNA

WHEN DESELECTING, TERMINATING OR SHIELDING TOP ANTENNA IS NOT POSSIBLE OR PRACTICAL, USE SETUP POSITION THAT HAS AIRCRAFT BLOCKING LINE OF SIGHT TO TOP ANTENNA.

05818A

Ramp Testing
Figure 1

- Press SETUP Control Key to display setup screens. Continue pressing SETUP Control Key to cycle to SETUP-XPDR Screen. Use NEXT PARAM and PREV PARAM Soft Keys to select each parameter.

SETUP-XPDR		BAT 2.5 Hr	
ANTENNA: BOTTOM		RF PORT:ANTENNA	
	ANT RANGE	ANT HEIGHT	
TOP:	50.0 ft	10.0 ft	
BOTTOM:	50.0 ft	0.0 ft	
ANT CABLE LEN:	6 ft	ANT GAIN (dBi)	
ANT CABLE LOSS:	1.8 dB	0.96 GHz: 7.5	
COUPLER LOSS:	0.8 dB	1.03 GHz: 7.1	
UT ADDRESS:	AUTO	1.09 GHz: 6.1	
MANUAL AA:	123456	PWR LIM: FAR 43	
DIV TEST:	ON	RAD47:	OFF
DECODER TEST:	ON	CHECK CAP:	YES
ADSB SETUP	PREV PARAM	NEXT PARAM	TEST DATA

2.4 XPDR SETUP AND TESTING DIRECT CONNECT

STEP	PROCEDURE
6.	Select ANTENNA: Set to TOP or BOTTOM depending on which aircraft antenna Test Set is pointing towards.
7.	Select RF PORT: Set to ANTENNA.
8.	Select ANT RANGE: Set to setup range from IFR 6000 antenna to UUT Antenna.
9.	Select ANT HEIGHT: Set to setup height from IFR 6000 antenna to UUT Antenna.
10.	Select ANT CABLE LOSS: Set to cable loss found on cable.
11.	Select ANT GAIN (dBi): Set 0.96 GHz, 1.03 GHz and 1.09 GHz antenna gain to figures marked on supplied Directional Antenna
12.	Select UUT ADDRESS: Set to AUTO. NOTE: If aircraft is on the ground set to MANUAL and enter in MANUAL ADDRESS. Mode S all-calls do not work when the aircraft is on the ground.
13.	Select DIVERSITY: Set to OFF. NOTE: To run diversity test set DIVERSITY to ON and install boot to bottom/top antenna.
14.	Select CHECK CAP: Set to YES. NOTE: CHECK CAP is a MODE S CONFIG only and will default to NO for ATCRBS CONFIG.
15.	Select PWR LIM: Set to FAR 43.
16.	Select DECODER TEST: Set to ON.
17.	Select RAD47: Set to OFF. NOTE: RAD47 is an Australian directive for civil aviation where the reply pulse width is between 0.35 to 0.55 us and amplitude variation (droop) is not greater than 1dB. Set to ON if applicable.

STEP	PROCEDURE
1.	Connect long RF coaxial cable between the aircraft antenna feeder cable and Test Set RF I/O Connector.
2.	Power On Aircraft and configure aircraft for weight off wheels.
3.	Power Up: Press the POWER Key to power the Test Set. Press SETUP Control Key to display setup screens. Continue pressing SETUP Control Key to cycle to SETUP-XPDR Screen. Use NEXT PARAM and PREV PARAM Soft Keys to select each parameter.
4.	Select RF PORT: Set to DIRECT CONNECT.
5.	Select DIR CABLE LOSS: Set to loss found on cable.
6.	Select UUT ADDRESS: Set to AUTO. NOTE: If aircraft is on the ground set to MANUAL and enter in MANUAL ADDRESS. Mode S all-calls do not work when the aircraft is on the ground.
7.	Select DIVERSITY: Set to ON.
8.	Select DECODER TEST: Set to ON.
9.	Select CHECK CAP: Set to YES.
10.	Select PWR LIM: Set to FAR 43.
11.	Select RAD47: Set to OFF. NOTE: RAD47 is an Australian directive for civil aviation where the reply pulse width is between 0.35 to 0.55 us and amplitude variation (droop) is not greater than 1dB. Set to ON if applicable.

2.5 XPDR SETUP AND TESTING ANTENNA COUPLER CONNECT

STEP	PROCEDURE	STEP	PROCEDURE
1.	<p>Connect Antenna Coupler to Aircraft Antenna.</p> <ul style="list-style-type: none"> Place Coupler over the antenna, guiding antenna into the slot on the bottom of the coupler. Push Coupler firmly against the aircraft skin until the black rubber gasket on the rim of the coupler is completely depressed tightly against the aircraft. Lock coupler into place by pushing white lever on the side of the coupler into a down and locked position. <p>NOTE: Coupler must be tightly pressed and locked in place for Test Set to function correctly. Coupler will lock into place when the black rubber gasket is not completely depressed against the aircraft, but the Test Set will not measure functions accurately.</p>	11.	Select CHECK CAP: Set to YES
		12.	Select PWR LIM: Set to FAR 43.
		13.	Select RAD47: Set to OFF.
			NOTE: RAD47 is an Australian directive for civil aviation where the reply pulse width is between 0.35 to 0.55 us and amplitude variation (droop) is not greater than 1 dB. Set to ON if applicable.
2.	Connect long RF coaxial cable between the Antenna Coupler and Test Set RF I/O Connector.		
3.	Power On Aircraft and configure aircraft for weight off wheels.		
4.	<p>Power Up: Press the POWER Key to power the Test Set.</p> <p>Press SETUP Control Key to display setup screens. Continue pressing SETUP Control Key to cycle to SETUP-XPDR Screen. Use NEXT PARAM and PREV PARAM Soft Keys to select each parameter.</p>		
5.	Select RF PORT: Select DIR W/COUPLER		
6.	Select CPL CABLE LOSS: Set to loss found on cable.		
7.	Select COUPLER LOSS: Set to loss found on coupler.		
8.	Select UUT ADDRESS: Set to AUTO.		
	NOTE: If aircraft is on the ground set to MANUAL and enter in MANUAL ADDRESS. Mode S all-calls do not work when the aircraft is on the ground.		
9.	Select DIVERSITY: Set to ON.		
10.	Select DECODER TEST: Set to ON.		

2.6 XPDR TESTING

STEP PROCEDURE

1. Press XPDR Mode Key to return to XPDR Auto Test Screen.

```

XPDR - CONFIG SCREEN          BAT 2.5 Hr

1  GENERIC ATCRBS
2  ATCRBS CLASS A
3  ATCRBS CLASS B
4  GENERIC MODE S
5  MODE S CLASS A
6  MODE S CLASS B
7  MODE S CL B OPT FREQ
8  MODE S CL B OPT PWR

INFO  RETURN
    
```

2. Press CONFIG Soft Key to display XPDR CONFIG Screen. Use Data Keys to select configuration file. Press RETURN Soft Key to confirm selection.

NOTE: If transponder class is not known, select GENERIC ATCRBS or GENERIC MODE S configuration file.

```

XPDR - AUTO TEST          PASS          BAT 2.5 Hr

CONFIG:GENERIC MODE S          LEVEL =4
ANTENNA: BOTTOM

REPLIES = A, C, S          FREQ = 1090.12 MHZ
TOP ERP = 57.1 dBm          MTL = -74.0 dBm
BOT ERP = 56.0 dBm          MTL = -73.1 dBm
A CODE = 1234 ID          C ALT = 100,000 ft
S CODE = 1234 ID          S ALT = 100,000 ft
TAIL = N12345          DF17 = DETECTED
FLIGHTID = BA234          AA=AC3421(53032041)
FS = 3 - ALERT          NO SPI          ON GROUND
VS = ON GND          COUNTRY = USA

RUN TEST          TEST LIST          CONFIG          SELECT ANT
    
```

STEP PROCEDURE

3. To run a complete FAR Part 43 Appendix F Test, press RUN TEST Soft Key to start Auto Test. When Auto Test completes, a PASS or FAIL indication is displayed at the top of the screen.
4. Most UUT parameters requiring user verification are displayed on the Auto Test Screen.
5. VS and FS discretes: To verify status, ensure UUT is in airborne state prior to running test. Run test and confirm that VS and FS fields indicate IN AIR. Place UUT in ground state, repeat test and confirm VS and FS fields indicate ON.
6. TAIL and COUNTRY: Displays the country decoded from the Mode S discrete address.

NOTE: If the country selected has not adopted an encoding scheme, only the country is displayed.
7. FLIGHT ID: UUT must have a valid source of Flight ID (internal or external to the UUT) to display data.
8. Press TEST LIST Soft Key to display complete Auto Test List. Use Data Keys to select desired test. Press SELECT Soft Key to display selected test.

```

XPDR - TEST LIST          BAT 2.5 Hr

1  AC/DECDR/SLS          - PASS
2  A/C F1/F2 SPACE/WIDTH - PASS
3  MODE A DURATION/AMP   - PASS
4  MODE C DURATION/AMP   - PASS
5  POWER/FREQ            - PASS
6  S ALL-CALL            - PASS
7  S REPLY TIMING        - PASS
8  S REPLY                - PASS
9  UF0                    - PASS
10 UF4                    - PASS
11 UF5                    - PASS
12 UF11                   - PASS

SELECT TEST          NEXT PAGE          RETURN
    
```

9. Press RETURN Soft Key to display Auto Test Screen.

2.6.1 ADS-B/GICB TESTING

- | STEP | PROCEDURE |
|------|--|
| 1. | Perform XPDR SETUP ANTENNA procedure or XPDR SETUP DIRECT CONNECT procedure. |
| 2. | Press SETUP Key until SETUP XPDR screen is displayed. |
| 3. | Press ADS-B SETUP Soft Key to display ADS-B/GICB Setup Screen. Use NEXT PARAM and PREV PARAM Soft Keys to select each parameter. |

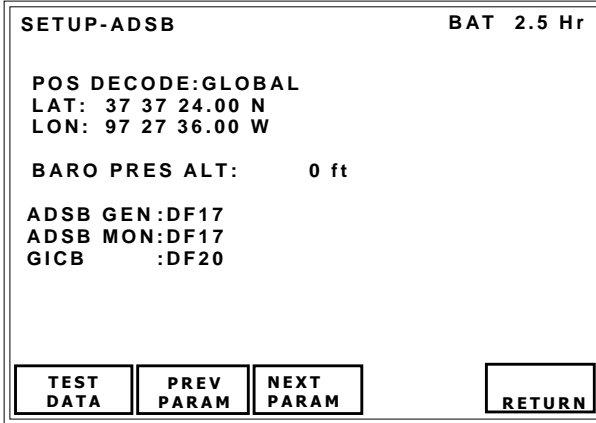

- Select POS DECODE: Set to GLOBAL to use global CPR algorithm for latitude and longitude decoding or simulation. Set to LOCAL to use local CPR algorithm for latitude and longitude decoding or simulation. POS DECODE is for BDS 0,5 and BDS 0,6.
- Select LAT: Enter local latitude in degrees, minutes and seconds.
- Select LONG: Enter local longitude in degrees, minutes and seconds.
- Select ADS-B GEN: Set DF17 or DF18 extended squitters to be generated.
- Select ADS-B MON: Set DF17 or DF18 extended squitters to be monitored.
- Select GICB: Set DF20 or DF21 to be requested with GICB protocol.

2.6.2 ADS-B MON

- | STEP | PROCEDURE |
|------|--|
| 1. | Press XPDR Mode Key until ADS-B/GICB/UAT MAIN menu is displayed. |

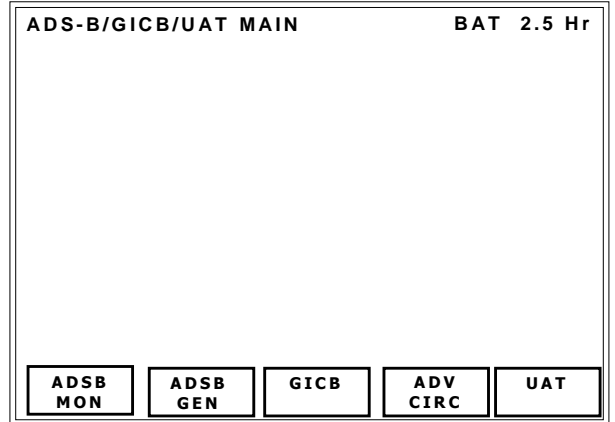

- Press the ADS-B MON Soft Key to display the ADS-B MON list screen.

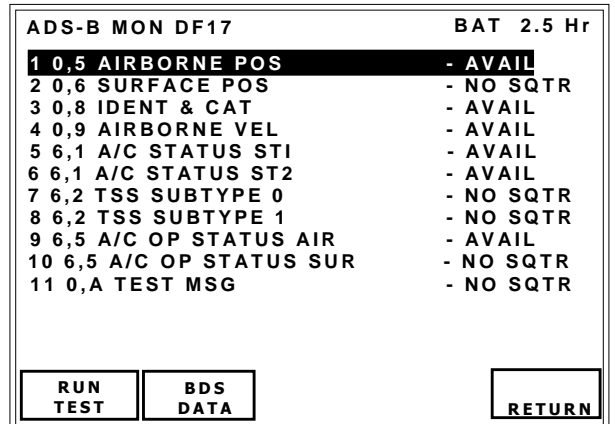

- Press RUN TEST soft key to start test. When a specific extended squitter BDS is captured, AVAIL will be displayed to the right of the BDS name.

STEP PROCEDURE

Use Data Keys to select specific BDS and press BDS DATA soft key to display selected BDS screen. Refer to ADS-B MON BDS screen example.

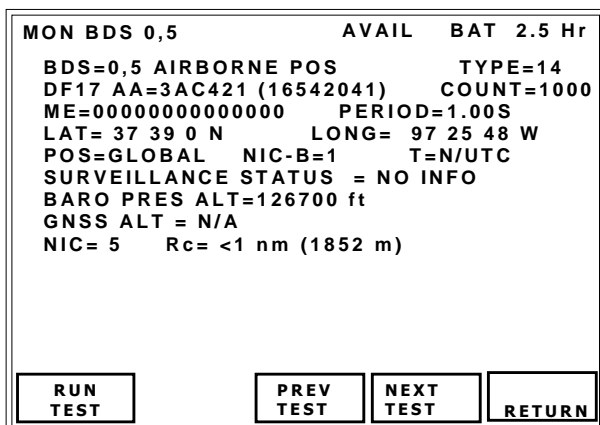

4. Press Return soft key to return to ADS-B MON list screen or press PREV TEST or NEXT TEST soft keys to select specific ADS-B MON BDS screens.

2.6.3 ADS-B GEN

STEP PROCEDURE

1. Press XPDR Mode Key until ADS-B/GICB Main Menu is displayed.
2. Press ADSB GEN to display the ADSB GEN List Screen.

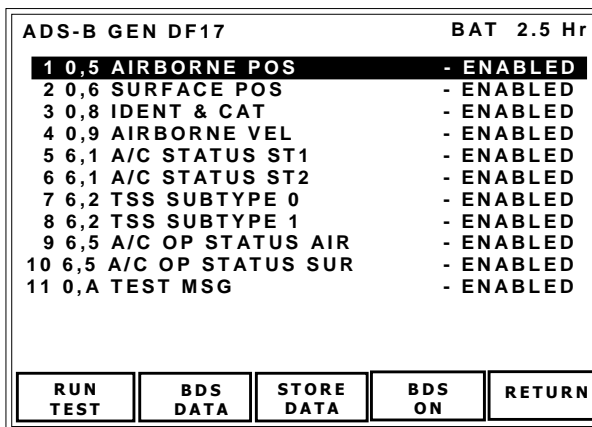

3. Press BDS ON Soft Key to enable selected test list items.
4. Press RUN TEST Soft Key to start test.
5. Press BDS DATA to enter selected test.
6. Press STORE DATA soft key to store or recall setups.

NOTE: The STORE soft key is not displayed while storage location 1 is selected.

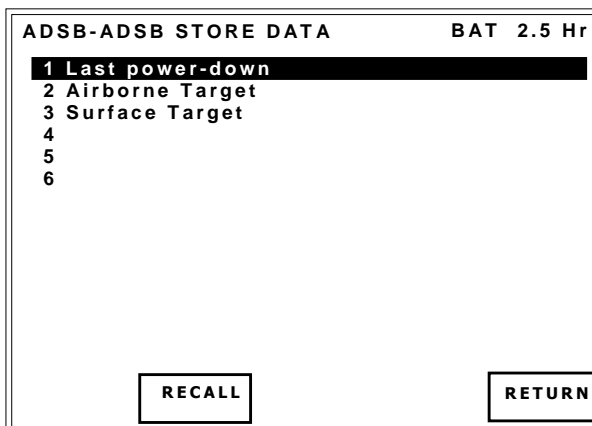

Airborne Target and Surface Target represent built-in target setup (Firmware Versions 03.15.01 or later and 04.14.00 or later only).

2.6.4 GICB

STEP PROCEDURE

1. Press XPDR Mode Key until ADS-B/GICB Main Menu is displayed.

GICB DF20		AVAIL	BAT 2.5 Hr
1	0,5 AIRBORNE POS	- AVAIL	
2	0,6 SURFACE POS	- NOT CAP	
3	0,7 SQTR STATUS	- AVAIL	
4	0,8 IDENT & CAT	- AVAIL	
5	0,9 AIRBORNE VEL	- AVAIL	
6	1,0 DATA LNK CAP	- AVAIL	
7	1,7 COM GICB CAP	- AVAIL	
8	1,8 SPEC SERV CAP #1	- AVAIL	
9	1,9 SPEC SERV CAP #2	- AVAIL	
10	1,A SPEC SERV CAP #3	- AVAIL	
11	1,B SPEC SERV CAP #4	- AVAIL	
12	1,C SPEC SERV CAP #5	- AVAIL	

RUN TEST

BDS DATA

NEXT PAGE

RETURN

2. Press GICB Soft Key to display the GICB List Screen.
3. Press RUN TEST soft key to start test. When a BDS is available, AVAIL will be displayed to the right of the BDS name.

GICB BDS 0,5		AVAIL	BAT 2.5 Hr
BDS=0,5 AIRBORNE POS		TYPE=14	
DF20 AA=3AC421 (16542041)			
MB=00000000000000			
LAT= 37 39 0 N		LONG= 97 25 48 W	
POS=GLOBAL NIC-B=1 T=N/UTC			
SURVEILLANCE STATUS = NO INFO			
BARO PRES ALT=126700 ft			
GNSS ALT = N/A			
NIC= 5 Rc= <1 nm (1852 m)			

RUN TEST

PREV TEST

NEXT TEST

RETURN

2.6.5 CIRCULAR

ADVISORY

STEP PROCEDURE

1. Press XPDR Mode Key until ADS-B/GICB Main Menu is displayed.

ADVISORY CIRCULARS MAIN		BAT 2.5 Hr
1	AC 20-165 AIR	- AVAIL
2	AC 20-165 SURFACE	- NOT RUN

AC DATA

RETURN

2. Press ADV CIRC Soft Key to display the ADVISORY CIRCULARS List Screen.
3. Select the test to run by pressing the AC DATA soft key.
4. Press RUN TEST soft key to start test.

ADV CIRC 20-165 AIR		PASS	BAT 2.5 Hr
LAT=37 29 31.33 N			
LON= 97 21 37.35 W			
POSITION ERROR=2.763 m			
NACP=11-EPU<0.0016 nm			
NIC=9 NACV=2			
E-W VEL= 111 kts E			
N-S VEL= 246 kts N			
ADS-B BARO ALT= 20000 ft			
XPDR BARO ALT= 20100 ft			
ALTITUDE ERROR= 100 ft			
GEOMETRIC ALT= 20225 ft			

RUN TEST

NEXT PAGE

RETURN

2.7 DME SETUP ANTENNA

STEP	PROCEDURE
1.	Mount Directional Antenna on Test Set and position friction hinge so Directional Antenna is as shown. Connect short RF coaxial cable between Antenna Connector and Test Set ANT Connector.
2.	Position Test Set at ≤ 50 ft (15.24 m) from and in line of sight with DME antenna.
3.	Power Up: Press the POWER Key to power the Test Set On.
4.	Press SETUP Control Key to display setup screens. Continue pressing SETUP Control Key to cycle to SETUP-DME Screen. Use NEXT PARAM and PREV PARAM Soft Keys to select each parameter.

SETUP - DME BAT 2.5 Hr

RF PORT : **DIRECT CONNECT**

ANT RANGE : -

	ANT GAIN (dBI)
IDENT TONE : IFR	0.96 GHz :7.5
DIR CABLE LEN: 25 FT	1.03 GHz :7.1
DIR CABLE LOSS: 4.5 dB	1.09 GHz :6.1
COUPLER LOSS: 0.8 dB	1.15 GHz :5.0
MAX RANGE: 200.00 nm	1.22 GHz :2.8

PREV
PARAM

NEXT
PARAM

DIAG

2.8 DME SETUP DIRECT CONNECT

STEP	PROCEDURE
1.	Connect long RF coaxial cable between the aircraft DME antenna feeder cable and Test Set RF I/O Connector.
2.	Power Up: Press the POWER Key to power the Test Set On.
3.	Press SETUP Control Key to display setup screens. Continue pressing SETUP Control Key to cycle to SETUP-DME Screen. Use NEXT PARAM and PREV PARAM Soft Keys to select each parameter.
4.	Select RF PORT: Set to DIRECT CONNECT.
5.	Select DIR CABLE LOSS: Set to loss found on cable.

5. Select RF PORT: Set to ANTENNA.
6. Select ANT RANGE: Set to line of sight distance from IFR 6000 antenna and UUT antenna.
7. Select ANT CABLE LOSS: Set to cable found on cable.
8. Select ANT GAIN: Set to gains found on supplied antenna.

2.9 DME SETUP ANTENNA COUPLER CONNECT

STEP	PROCEDURE
------	-----------

1. Connect Antenna Coupler to Aircraft Antenna.
 - Place Coupler over the antenna, guiding antenna into the slot on the bottom of the coupler.
 - Push Coupler firmly against the aircraft skin until the black rubber gasket on the rim of the coupler is completely depressed tightly against the aircraft.
 - Lock coupler into place by pushing white lever on the side of the coupler into a down and locked position.

NOTE: Coupler must be tightly pressed and locked in place for Test Set to function correctly. Coupler will lock into place when the black rubber gasket is not completely depressed against the aircraft, but the Test Set will not measure functions accurately.

2. Connect long RF coaxial cable between the Antenna Coupler and Test Set RF I/O Connector.
3. Power Up: Press the POWER Key to power the Test Set On.
4. Press SETUP Control Key to display setup screens. Continue pressing SETUP Control Key to cycle to SETUP-DME Screen. Use NEXT PARAM and PREV PARAM Soft Keys to select each parameter.
5. Select RF PORT: Set to DIR W/COUPLER.
6. Select CPL CABLE LOSS: Set to loss found on cable.
7. Select COUPLER LOSS: Set to loss found on coupler.

2.10 DME TESTING

STEP	PROCEDURE
------	-----------

1. Press DME Mode Select Key to display DME ModeTest Screen. All DME test data is displayed on this screen.

DME		BAT 2.5 Hr	
VOR : 108.00 MHz	RFLVL : -2 dBm	OUT	
FREQ : 978 MHz	RATE : 10 kts		
CHAN : 17X	RANGE : 0.00 nm		
% REPLY: 100		ECHO : OFF	
SQTR : ON		IDENT: ON	
TX FREQ = MHZ		ERP= dBm	
P1 WIDTH = us		PRF= Hz	
P2 WIDTH = us			
P1-P2 = us()			
UUTLVL = -38.2 dBm			
RUN TEST	PREV PARAM	NEXT PARAM	STOP RATE
			IN/OUT

2. Select VOR/FREQ/CHAN: Set to frequency of DME unit.
3. Select UUT LVL: Set to desired level.
4. Select RATE: Set to 300 kts OUT.
5. Select RANGE: Set to 0.00 nm.
6. Select % REPLY: Set to 100.
7. Select ECHO: Set to OFF.
8. Select SQTR: Set to ON.
9. Select IDENT: Set to ON.
10. Press RUN TEST Soft Key to start test.

NOTE: UUT parameters are modifiable while test is running.
11. Press STOP TEST Soft Key to stop test. Last UUT parameters are retained on display.

2.11 TCAS (TAS) SETUP ANTENNA

STEP	PROCEDURE
1.	Mount Directional Antenna on Test Set and position friction hinge so Directional Antenna is as shown. Connect short RF coaxial cable between Antenna Connector and Test Set ANT Connector.
2.	Position Test Set at Forward Sector Test Location, ≤50 ft (15.24 m) from and in line of sight with TCAS top antenna.
3.	Power Up: Press the POWER Key to power the Test Set On.
4.	Press SETUP Control Key to display setup screens. Continue pressing SETUP Control Key to cycle to SETUP-TCAS Screen. Use NEXT PARAM and PREV PARAM Soft Keys to select each parameter.

STEP	PROCEDURE
9.	Select ANT CABLE LOSS: Set to cable loss found on cable.
10.	Select ANT GAIN (dBi): Set 1.03 GHz and 1.09 GHz antenna gain to figures marked on supplied Directional Antenna.
11.	Select SQUITTERS: Set to ON.
11.	Select ALT REPORTING: Set to ON.
12.	Select DISPLAYED ALT: Set to RELATIVE.
13.	Select TEST SET AA: Set to A92493. NOTE: TEST SET AA needs to be different than the surrounding aircraft.

SETUP-TCAS BAT 2.5 Hr

RF PORT: **ANTENNA**

ANT RANGE : 12 ft

ANT HEIGHT : 1 ft

UUT ADDRESS:AUTO

MANUAL AA:000000

ANT CABLE LEN:25 FT

ANT CABLE LOSS:4.5 dB ANT GAIN(dBi)

SQUITTERS: ON 1.03 GHz: 7.1

ALT REPORTING: ON 1.09 GHz: 6.1

DISPLAYED ALT:RELATIVE

TEST SET AA:A92493

REPLY PARAM	PREV PARAM	NEXT PARAM	DIAG	STORE/ RECALL
----------------	---------------	---------------	------	------------------

5. Select RF PORT: Set to ANTENNA.
6. Select ANT RANGE: Set to setup range from antenna.
7. Select ANT HEIGHT: Set to setup height from antenna.
8. Select UUT ADDRESS: Set to AUTO.
NOTE: If aircraft is on the ground, set to MANUAL and enter in MANUAL ADDRESS. Mode S all-calls do not work when the aircraft is on the ground.

2.12 TCAS TESTING

STEP	PROCEDURE
------	-----------

1. Press TCAS Mode Select Key to display TCAS Test Screen.

TCAS		BAT 2.5 Hr	
SCENARIO: 0-CUSTOM			
TCAS TYPE:TCAS II		%REPLY: 100	
INTRUDER TYPE:MODE S			
RANGE START: 8.00 nm		STOP: --	
RANGE RATE : 300 kts		STOP: --	
ALT START: +200 ft		CONVERGE : ON	
ALT RATE :		ALT DETECT: ON	
UUT ALT : 31200 ft		ERP= 57.0 dBm	
FREQ= 1030.000 MHz		ALT= +200 ft ↓	
RANGE= 8.00 nm IN		TCAS STATUS= TRACKING	
STATUS= NON-THREAT		ENCOUNTER= 0:00	
RUN TEST	PREV PARAM	NEXT PARAM	MON
STORE / RECALL			

2. Select SENARIO: Set to CUSTOM.
3. Select TCAS TYPE: Set to TCAS II.
NOTE: If testing a TCAS I system set to TCAS I. If testing a TAS system, set to TAS.
4. Select % REPLY: Set to 100.
5. Select INTRUDER TYPE: Set to ATCRBS or Mode S.
6. Select RANGE START: Set to 8 nm.
7. Select RANGE RATE: Set to 300 kts.
8. Select ALT START: Set to +200 ft.
9. Select CONVERGE: Set to ON.
10. Select ALT DETECT: Set to ON.
11. Press RUN TEST Soft Key to start test.
12. Verify TCAS STATUS displays AQUIRING and then TRACKING. When TRACKING is annunciated, an intruder should be displayed on the TCAS display.

STEP	PROCEDURE
------	-----------

13. Verify UUT visual and audio operation:

NOTE: Verify Traffic Advisory at 40 sec until encounter time.

- Verify Resolution Advisory at 25 sec until encounter time
- Verify TCAS bearing reads 0°±15°).

NOTE: If Radio Altimeter Altitude is below 500 ft, RA's are inhibited.

NOTE: TCAS I systems do not issue RA's.

14. Press STOP TEST Soft Key to stop test.

2.13 TIS SETUP ANTENNA

STEP	PROCEDURE
1.	Mount Directional Antenna on Test Set and position friction hinge so Directional Antenna is as shown. Connect short RF coaxial cable between Antenna Connector and Test Set ANT Connector.
2.	Position Test Set ≤ 50 ft (15.24 m) from and in line of sight with top/bottom antenna.
3.	Power On Aircraft and configure aircraft for weight off wheels.
4.	Power Up: Press the POWER Key to power the Test Set On.

STEP	PROCEDURE
10.	Select ANT GAIN (dBi): set 1.03 GHz and 1.09 GHz antenna gain to figures marked on supplied Directional Antenna.
11.	Select UUT ADDRESS: Set to AUTO. NOTE: If aircraft is on the ground, set to MANUAL and enter MANUAL ADDRESS. Mode S all-calls do not work when the aircraft is on the ground.

SETUP-TIS AVAIL BAT 2.5 Hr

RF PORT: **ANTENNA**

ANT RANGE: 12 ft

ANT HEIGHT: 12 ft

ANT GAIN (dBi)

ANT CABLE LEN: 6 ft 1.03 GHz: 7.1

ANT CABLE LOSS: 1.8 dB 1.09 GHz: 6.1

UUT ADDRESS: AUTO

MANUAL AA:123456

PREV
PARAM

NEXT
PARAM

5. Press SETUP Control Key to display setup screens. Press SETUP Control Key to display SETUP-TIS Screen. Use NEXT PARAM and PREV PARAM Soft Keys to select each parameter.
6. Select RF PORT: Set to ANTENNA.
7. Select ANT RANGE: Set to setup range from IFR 6000 antenna to UUT Antenna.
8. Select ANT HEIGHT: Set to setup height from IFR 6000 antenna to UUT Antenna.
9. Select ANT CABLE LOSS: Set to cable loss found on cable.

2.14 TIS SETUP DIRECT CONNECT

- | STEP | PROCEDURE |
|------|--|
| 1. | Connect long RF coaxial cable between aircraft antenna feeder cable and Test Set RF I/O Connector. |
| 2. | Power On Aircraft and configure aircraft for weight off wheels. |
| 3. | Power Up: Press POWER Key to power the Test Set. |
| 4. | Press SETUP Control Key to display setup screens. Press SETUP Control Key until SETUP-TIS Screen is displayed. Use NEXT PARAM and PREV PARAM Soft Keys to select each parameter. |
| 5. | Select RF PORT: Set to DIRECT CONNECT. |
| 6. | Select DIR CABLE LOSS: Set cable loss to cable loss found on cable. |
| 7. | Select UUT ADDRESS: Set to AUTO. |

2.15 TIS TESTING

- | STEP | PROCEDURE |
|------|---|
| 1. | Press TCAS Mode Key until TIS Test Screen is displayed. |

TIS		BAT 2.5 Hr	
TARGETS:5		UUT HDG:180 deg	
	1	2	3
BRG(deg) :	120	90	234
RNG(nm) :	6.00	4.00	3.00
ALT(ft) :	3500	2000	1000
ALT RATE:CLIMB	LEVEL	LEVEL	CLIMB
HDG(deg) :	234	178	56
TRAFFIC :	PROX	PROX	PROX
ADDR=3AC421 (16542041) N12345		ALT =126700 ft	
TSCR= 5		TSDR= 1	
TIS STATUS=CONNECTING		INFO=0000	
RUN TEST	PREV PARAM	NEXT PARAM	

- Use NEXT PARAM and PREV PARAM Soft Keys to select each of the following parameters:
 - TARGETS: Sets the number of simulated targets 0 to 5.
 - UUT HDG: Provides entry for UUT Heading in degrees. This orientates the target bearings with respect to UUT (aircraft) heading.
 - BRG: Sets target bearing relative to UUT (aircraft) in degrees
 - RNG: Sets targets range relative to UUT (aircraft) in nautical miles.
 - ALT: Sets target altitude relative to UUT (aircraft) in feet.
 - ALT RATE: Sets Altitude Rate annunciation on TIS display.
 - HDG: Sets target Heading in degrees.
 - TRAFFIC: Sets target traffic status on TIS display.
- Press RUN Soft Key to start test.
- TIS display shows the selected target parameters in accordance with the selections:
 - TIS STATUS field indicates TIS connection status.
 - ADDR indicates UUT Aircraft Address.
 - ALT UUT field displays UUT aircraft altitude.
 - TSCR field indicates number of TIS connects requested from UUT.
 - TSDR field indicates number of TIS disconnects requested from UUT.

2.16 UAT MON

STEP	PROCEDURE
------	-----------

1. Press XPDR Mode Key until ADS-B/GICB/UAT MAIN menu is displayed.

ADS-B/GICB/UAT MAIN		BAT 2.5 Hr		
ADSB MON	ADSB GEN	GICB	ADV CIRC	UAT

2. Press the UAT Soft Key to display the UAT MAIN screen.

UAT MAIN		BAT 2.5 Hr	
UAT MON	UAT GEN	GPS STATUS	RETURN

STEP	PROCEDURE
------	-----------

3. Press UAT MON soft key to display the UAT ADS-B MON screen.

UAT ADS-B MON		BAT 2.5 Hr	
GPS SYNC			
ORD	AA	PTC	ADDR QUAL
1			
2			
3			
4			
5			
6			
7			
RUN TEST	MON LIST	RETURN	

4. Press RUN TEST soft key to start the test. Press the MON LIST soft key to display the data of the selected aircraft.

UAT ADS-B MON		BAT 2.5 Hr	
GPS SYNC			
ORD	AA	PTC	ADDR QUAL
1	654321	0 1 2	0
2	654322	0 3 6	1
3	654323	1 4	2
4	654324	1 4 5	3
5	654325	0 1	4
6			
7			
RUN TEST	MON LIST	RETURN	

STEP PROCEDURE

- 5. Press SELECT to display the data of the selected message.

```
UAT ADS-B MON LIST          BAT 2.5 Hr
                             GPS SYNC
AA=654321 (31241441)
1 State Vector              AVAIL
2 Aux State Vector          AVAIL
3 Mode Status               AVAIL
4 Target State              AVAIL

*****TESTING*****

STOP TEST  SELECT  RETURN
```

- 6. Press the NEXT PAYLD Soft Key to cycle through the valid payloads of the message type displayed. Press NEXT DATA to display the next message type.

```
UAT ADS-B          BAT 2.5 Hr
STATE VECTOR      GPS SYNC
ADD QUAL=ADS-B ICAO   PTC=2
AA=3214AA (14412252)  NIC=7
A/G STATE=SUBSONIC   UTC CPLD=YES
LAT=37 37 24.00 N    FB CODE=7
LON= 97 27 36.00 W
SOUTH VELOCITY=311 kts
WEST VELOCITY=236 kts
BARO VERT RATE=64 ft/min
BARO PRES ALT=2775 ft
FREQ=978.00 MHz      ERP=42.0 dBm

*****TESTING*****

RUN TEST  NEXT PAYLD  NEXT DATA  RETURN
```

2.17 UAT FIS-B GEN

STEP	PROCEDURE
------	-----------

1. Press XPDR Mode Key until ADS-B/GICB/UAT MAIN menu is displayed.

ADS-B/GICB/UAT MAIN				BAT 2.5 Hr	
ADSB MON	ADSB GEN	GICB	ADV CIRC	UAT	

2. Press the UAT Soft Key to display the UAT MAIN screen.

UAT MAIN				BAT 2.5 Hr	
UAT MON	UAT GEN	GPS STATUS	RETURN		

STEP	PROCEDURE
------	-----------

3. Press UAT GEN soft key to display the UAT GEN LIST screen.

UAT GEN LIST		BAT 2.5 Hr	
		GPS SYNC	
1 FIS-B	-		
2 TIS-B	-		
3 ADS-B	-		
SELECT		RETURN	

4. Select FIS-B; then press SELECT soft key to display the UAT FIS-B GEN screen. Press PREV PARAM and NEXT PARAM soft keys to navigate through the parameters. Press the RUN TEST soft key to start the test.

UAT FIS-B GEN		BAT 2.5 Hr	
		GPS SYNC	
REPORT: METAR	STN: KICT	DAY/TIME: 030100Z	
DATA: 17018G23KT 10SM FEW220 25/07 A2998 RMK A02 SLP147 T02500067			
GND LAT: 37 38 59.80 N LON: 97 25 59.00 W SLOT ID: 0			
RUN TEST	PREV PARAM	NEXT PARAM	RETURN

2.18 UAT TIS-B GEN

STEP	PROCEDURE
------	-----------

1. Press XPDR Mode Key until ADS-B/GICB/UAT MAIN menu is displayed.

ADS-B/GICB/UAT MAIN				BAT 2.5 Hr	
ADSB MON	ADSB GEN	GICB	ADV CIRC	UAT	

2. Press the UAT Soft Key to display the UAT MAIN screen.

UAT MAIN			BAT 2.5 Hr	
UAT MON	UAT GEN	GPS STATUS	RETURN	

STEP	PROCEDURE
------	-----------

3. Press UAT GEN soft key to display the UAT GEN LIST screen.

UAT GEN LIST				BAT 2.5 Hr	
				GPS SYNC	
1 FIS-B	-				
2 TIS-B	-				
3 ADS-B	-				
SELECT			RETURN		

4. Select TIS-B; then press SELECT soft key to display the UAT TIS-B GEN screen. Press PREV PARAM and NEXT PARAM soft keys to navigate through the parameters. Press STORE DATA soft key to store or recall setups. Press the RUN TEST soft key to start the test.

UAT TIS-B GEN				BAT 2.5 Hr	
				GPS SYNC	
TARGETS: 5	UUT HDG:			0 deg	
BRG(deg) :	1	2	3	4	5
RNG(nm) :	0	0	0	0	0
ALT(100ft):	0.0	0.0	0.0	0.0	0.0
ALT RATE :	0	0	0	0	0
HDG(deg) :	Climb	Climb	Climb	Climb	Climb
UUT ALT :	0	0	0	0	0
UUT LAT :	0	0	0.00	N	
UUT LON :	0	0	0.00	E	
TIS-B SITE ID:	0	PYLD SEQ:		3,6,0,6	
RUN TEST	STORE DATA	PREV PARAM	NEXT PARAM	RETURN	

2.19 UAT ADS-B GEN

STEP	PROCEDURE
------	-----------

1. Press XPDR Mode Key until ADS-B/GICB/UAT MAIN menu is displayed.

ADS-B/GICB/UAT MAIN		BAT 2.5 Hr		
ADSB MON	ADSB GEN	GICB	ADV CIRC	UAT

2. Press the UAT Soft Key to display the UAT MAIN screen.

UAT MAIN		BAT 2.5 Hr	
UAT MON	UAT GEN	GPS STATUS	RETURN

STEP	PROCEDURE
------	-----------

3. Press UAT GEN soft key to display the UAT GEN LIST screen.

UAT GEN LIST		BAT 2.5 Hr	
		GPS SYNC	
1 FIS-B	-		
2 TIS-B	-		
3 ADS-B	-		
SELECT			RETURN

4. Select ADS-B; then press SELECT soft key to display the UAT ADS-B GEN screen. Press PREV PARAM and NEXT PARAM soft keys to navigate through the parameters. Press STORE DATA soft key to store or recall setups. Press the RUN TEST soft key to start the test.

UAT ADS-B GEN		BAT 2.5 Hr		
		GPS SYNC		
TARGETS: 5	UUT HDG:	0 deg		
BRG(deg) : 0	1 2 3 4 5	0 0 0 0 0		
RNG(nm) : 0.0	0.0 0.0 0.0	0.0 0.0		
ALT(100ft): 0	0 0 0	0 0 0		
ALT RATE : Clmb	Clmb Clmb Clmb	Clmb Clmb		
HDG(deg) : 0	0 0 0	0 0 0		
UUT ALT : 0 ft				
UUT LAT : 0 0	0.00 N			
UUT LON : 0 0	0.00 E			
PYLD SEQ: 3,6,0,6	AG: AIR			
RUN TEST	STORE DATA	PREV PARAM	NEXT PARAM	RETURN

SECTION 2 - OPERATION

1. INSTALLATION

1.1 GENERAL

The IFR 6000 is powered by an internal Lithium-Ion battery pack. The Test Set is supplied with an external DC Power Supply that enables the operator to recharge the battery when connected to AC power.

NOTE: The IFR 6000 can operate continuously on AC power via the DC Power Supply, for servicing and/or bench tests.

Refer to 1-2-2, Figure 2 for location of controls, connectors, or indicators.

1.2 BATTERY OPERATION

The internal battery is equipped to power the IFR 6000 for six hours of continuous use, after which time, the IFR 6000 battery needs recharging. Battery Operation Time Remaining (in Hours) is displayed on all screens.

The IFR 6000 contains an automatic time-out to conserve power. If a key is not pressed within a 5-to-20-minute time period, the Test Set shuts Off (only when using battery power). The Power Down Time may be set in the Setup Screen.

1.3 BATTERY CHARGING

The battery charger operates whenever DC power (11 to 32 Vdc) is applied to the Test Set with the supplied DC Power Supply or a suitable DC power source. When charging, the battery reaches a 100% charge in approximately four hours. The internal battery charger allows the battery to charge between a temperature range of 5° to 40°C. The IFR 6000 can operate, connected to an external DC source, outside the battery charging temperature range (5° to 40°C).

The battery should be charged every three months (minimum) or disconnected for long term inactive storage periods of more than six months. The Battery must be removed when conditions surrounding the Test Set are <-20°C or >60°C.

1.4 SAFETY PRECAUTIONS

The following safety precautions must be observed during installation and operation. VIAVI assumes no liability for failure to comply with any safety precaution outlined in this manual.

1.4.1 Complying with Instructions

Installation/operating personnel should not attempt to install or operate the IFR 6000 without reading and complying with instructions contained in this manual. All procedures contained in this manual must be performed in exact sequence and manner described.

1.4.2 Grounding Power Cord

WARNING: DO NOT USE A THREE-PRONG TO TWO-PRONG ADAPTER PLUG. DOING SO CREATES A SHOCK HAZARD BETWEEN THE CHASSIS AND ELECTRICAL GROUND.

For AC operation, the AC Line Cable, connected to the DC Power Supply, is equipped with standard three-prong plug and must be connected to a properly grounded three-prong receptacle that is easily accessible. It is the customer's responsibility to:

- Have a qualified electrician check receptacle(s) for proper grounding.
- Replace any standard two-prong receptacle(s) with properly grounded three-prong receptacle(s).

1.4.3 Operating Safety

Due to potential for electrical shock within the Test Set, the Case Assembly must be closed when the Test Set is connected to an external power source.

Battery replacement, fuse replacement and internal adjustments must only be performed by qualified service technicians.

1.5 AC POWER REQUIREMENTS

The DC Power Supply, supplied with the IFR 6000, operates over a voltage range of 100 to 250 VAC at 47 to 63 Hz.

The battery charger operates whenever DC power (11 to 32 Vdc) is applied to the Test Set with the supplied DC Power Supply or a suitable DC power source. When charging, the battery reaches an 100% charge in approximately four hours. The Battery Charging temperature range is 5° to 40°C, controlled by an internal battery charger.

1.6 BATTERY RECHARGING

Refer to 1-2-1, Figure 1.

STEP	PROCEDURE
1.	Connect AC Line Cable to either: <ul style="list-style-type: none"> ● AC PWR Connector on the DC Power Supply and an appropriate AC power source ● Suitable DC power source
2.	Connect the DC Power Supply to the DC POWER Connector on the IFR 6000.
3.	Verify the CHARGE Indicator illuminates yellow.
4.	Allow four hours for battery charge or until the CHARGE Indicator illuminates green.

NOTE: If the CHARGE Indicator flashes yellow and/or the battery fails to accept a charge and the IFR 6000 does not operate on battery power, the battery, serviceable only by a qualified technician, requires replacement. Refer to Battery/Voltage Instructions.

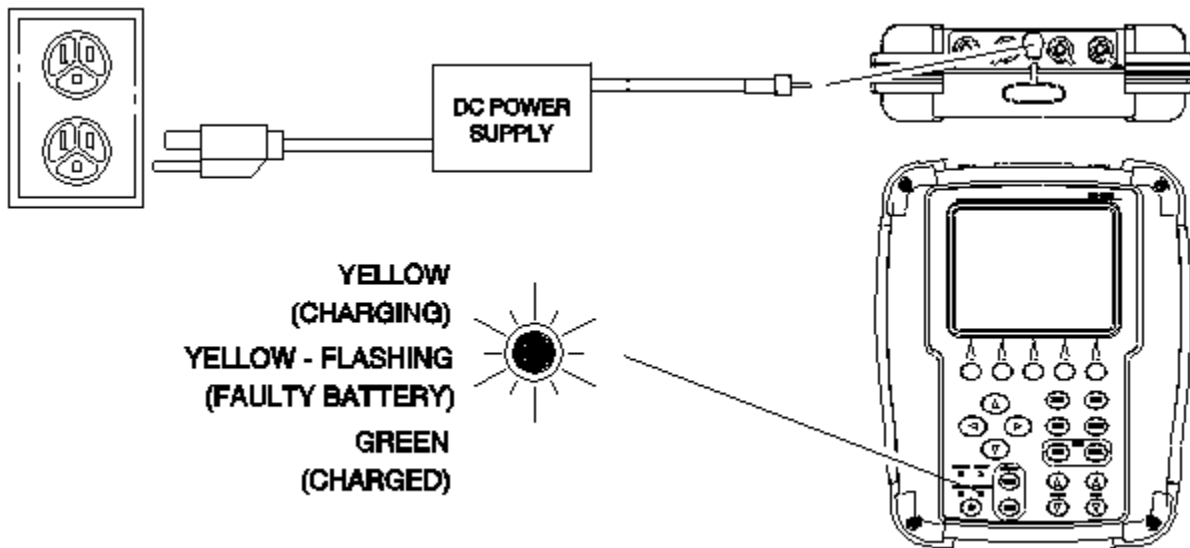

Battery Recharging
Figure 1

1.7 EXTERNAL CLEANING

The following procedure contains routine instructions for cleaning the outside of the Test Set.

CAUTION: DISCONNECT POWER FROM TEST SET TO AVOID POSSIBLE DAMAGE TO ELECTRONIC CIRCUITS.

STEP	PROCEDURE
1.	Clean front panel buttons and display face with soft lint-free cloth. If dirt is difficult to remove, dampen cloth with water and a mild liquid detergent.
2.	Remove grease, fungus and ground-in dirt from surfaces with soft lint-free cloth dampened (not soaked) with isopropyl alcohol.
3.	Remove dust and dirt from connectors with soft-bristled brush.
4.	Cover connectors, not in use, with suitable dust cover to prevent tarnishing of connector contacts.
5.	Clean cables with soft lint-free cloth.
6.	Paint exposed metal surface to avoid corrosion.

THIS PAGE INTENTIONALLY LEFT BLANK.

2. CONTROLS, CONNECTORS AND INDICATORS

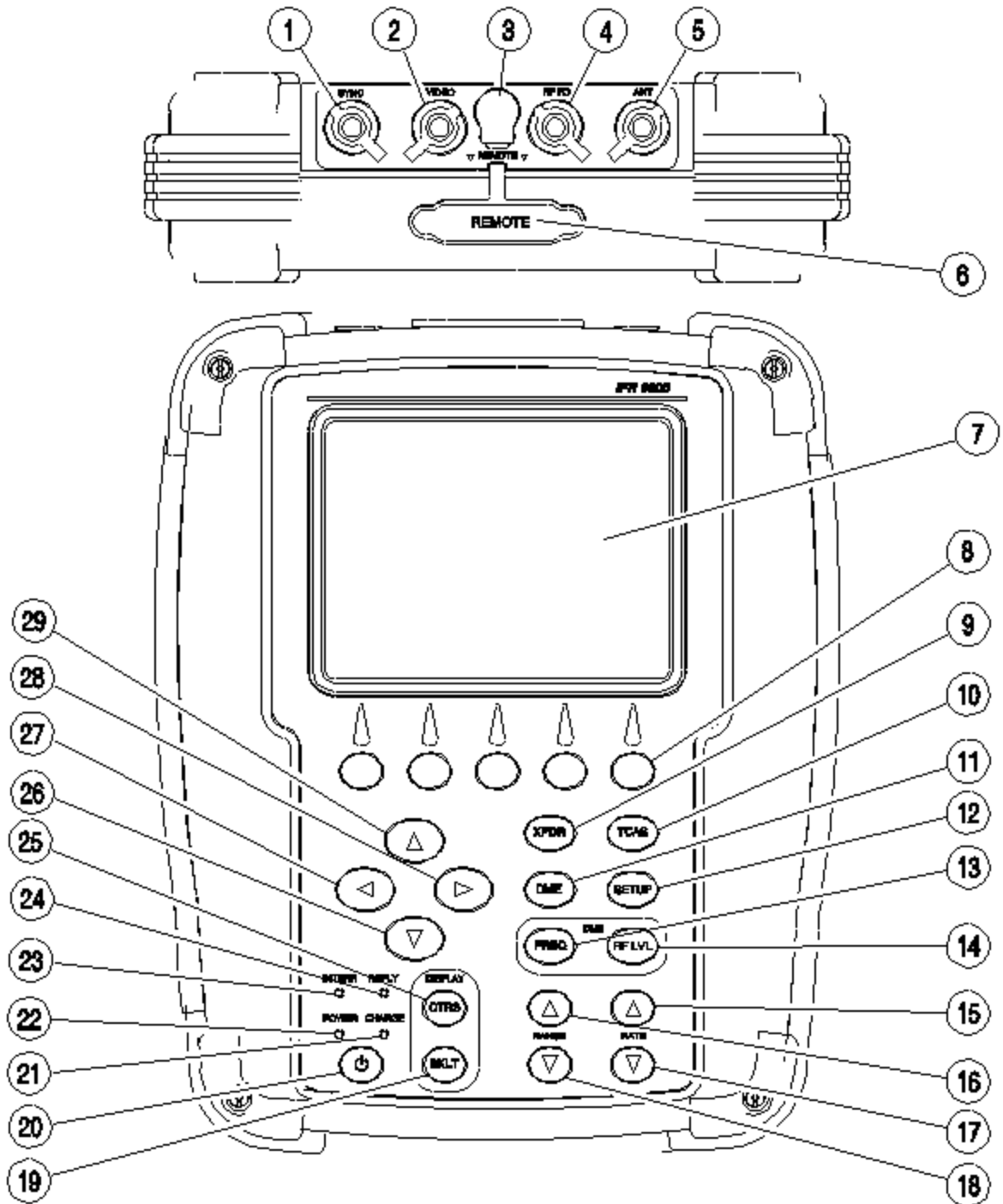

IFR 6000 Front Panel
Figure 1

NUMERICAL LOCATION LIST		ALPHABETICAL LOCATION LIST	
1.	Test Set GPS Connector	ALTITUDE ENCODER Connector	38
2.	VIDEO Connector	ANT Connector	31
3.	DC POWER Connector	AUX IN Connector	39
4.	RF I/O Connector	AUX OUT Connector 1	31
5.	Test Set ANT Connector	AUX OUT Connector 2	33
6.	REMOTE Connector	AUX OUT Connector 3	34
7.	Display	AUX OUT Connector 4	35
8.	Multi-Function Soft Keys	BACKLIGHT Key	19
9.	XPDR Mode Select Key	CHARGE Indicator	21
10.	TCAS Mode Select Key	CONTRAST Key	25
11.	DME Mode Select Key	DC POWER Connector	3
12.	SETUP Select Key	DECREMENT/SELECT Data Key	26
13.	FREQ Select Key	Display	7
14.	RF LVL Key	DME Mode Select Key	11
15.	RATE INCREMENT Key	FREQ Select Key	13
16.	RANGE INCREMENT Key	GPS Connector	30
17.	RATE DECREMENT Key	INCREMENT/SELECT Data Key	29
18.	RANGE DECREMENT Key	INTERR Indicator	23
19.	BACKLIGHT Key	Multi-Function Soft Keys	8
20.	POWER Key	POWER Indicator	22
21.	CHARGE Indicator	POWER Key	20
22.	POWER Indicator	RANGE DECREMENT Key	18
23.	INTERR Indicator	RANGE INCREMENT Key	16
24.	REPLY Indicator	RATE DECREMENT Key	17
25.	CONTRAST Key	RATE INCREMENT Key	15
26.	DECREMENT/SELECT Data Key	REMOTE Connector	6
27.	SELECT DATA UNIT MSB Key	REMOTE Connector	41
28.	SELECT DATA UNIT LSB Key	REPLY Indicator	24
29.	INCREMENT/SELECT Data Key	RF I/O Connector	4
30.	GPS Connector	RF LEVEL Key	14
31.	ANT Connector	RS-232 Connector	40
32.	AUX OUT Connector 1	SETUP Select Key	12
33.	AUX OUT Connector 2	SELECT DATA UNIT MSB Key	27
34.	AUX OUT Connector 3	SELECT DATA UNIT LSB Key	28
35.	AUX OUT Connector 4	Test Set GPS Connector	1
36.	USB HOST Connector	TCAS Mode Select Key	10
37.	USB DEVICE Connector	Test Set ANT Connector	5
38.	Altitude Encoder Connector	USB DEVICE Connector	37
39.	AUX IN Connector	USB HOST Connector	36
40.	RS-232 Connector	VIDEO Connector	2
41.	REMOTE Connector	XPDR Mode Key	9

ITEM	DESCRIPTION
1.	<p>Test Set GPS Connector (Hardware Modification 2 or later)</p> <p>With the UAT option, the BNC type connector functions as the GPS antenna connector; otherwise, the connector is inactive. The AUX Out 3 Connector (34) on the Breakout Box is the SYNC Connector and provides synchronization pulses for each test set transmission, e.g., interrogation, reply, squitter.</p> <p>NOTE: For Hardware Modification 1 and earlier, this connector was designated as the SYNC Connector.</p>
2.	<p>VIDEO Connector</p> <p>BNC type connector provides interrogation and reply pulses.</p>
3.	<p>DC POWER Connector</p> <p>Circular Type Connector (2.5 mm center, 5.5 mm outer diameter, center positive) used for battery charging or operation of Test Set.</p>
4.	<p>RF I/O Connector</p> <p>CAUTION: MAXIMUM INPUT TO THE RF I/O CONNECTOR MUST NOT EXCEED 5 KW PEAK OR 30 W AVERAGE.</p> <p>TNC Type connector used for direct connection to UUT antenna connector.</p>
5.	<p>Test Set ANT Connector</p> <p>TNC Type Connector used for connection to the IFR 6000 directional antenna for over the air testing.</p>
6.	<p>REMOTE Connector</p> <p>Type HD DB44 Connector used for remote operation and software upgrades. Contains RS-232, USB Host and USB Peripheral connections (altitude encoder inputs and SYNC outputs).</p>
7.	<p>Display (LCD)</p> <p>38 characters by 16 lines for main screen display with Soft Key boxes at the bottom of the screen.</p>
8.	<p>Multi-Function Soft Keys</p> <p>Legends for the five soft keys are displayed in boxes at the bottom of the Display (LCD) screen.</p>
9.	<p>XPDR MODE Select Key</p> <p>Selects Transponder Auto Test Screen.</p>

ITEM	DESCRIPTION
10.	<p>TCAS MODE Select Key</p> <p>Selects TCAS Auto Test Screen.</p>
11.	<p>DME MODE Select Key</p> <p>Selects DME Test Screen.</p>
12.	<p>SETUP Key</p> <p>Displays the SETUP Menu.</p>
13.	<p>FREQ Select Key</p> <p>Selects DME Frequency as VOR Paired, TACAN Channel or MHz.</p>
14.	<p>RF LVL Key</p> <p>DME mode function only. Selects DME range reply and squitter RF level.</p>
15.	<p>RATE INCREMENT Key</p> <p>Increments DME or TCAS range rate.</p>
16.	<p>RANGE INCREMENT Key</p> <p>Increments DME or TCAS range.</p>
17.	<p>RATE DECREMENT Key</p> <p>Decrements DME or TCAS range rate.</p>
18.	<p>RANGE DECREMENT Key</p> <p>Decrements DME or TCAS range.</p>
19.	<p>BACKLIGHT Key</p> <p>Displays/exits the Backlight Adjust Field.</p> <p>INCREMENT/SELECT Data Key or DECREMENT/SELECT Data Key may be used to adjust the Backlight Intensity.</p> <p>The IFR 6000 powers up with the Backlight set to the setting of the previous session.</p>
20.	<p>POWER Key</p> <p>Powers the IFR 6000 ON and OFF.</p>

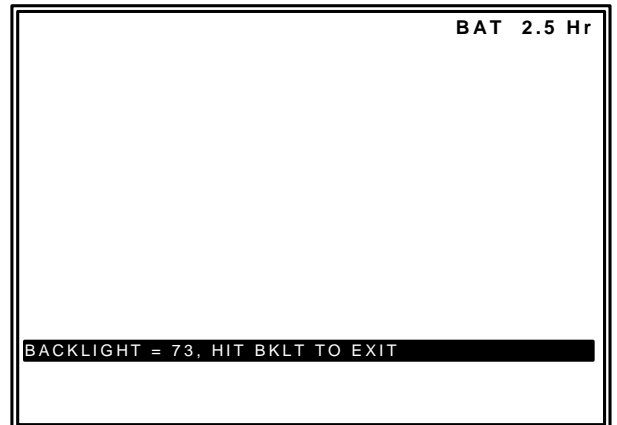

ITEM DESCRIPTION

- 21. CHARGE Indicator
Illuminated when external DC power is applied for Bench Operation or Battery charging.
CHARGE Indicator is yellow when the battery is charging, flashing yellow when the battery needs replacing and green when the battery is fully charged.
- 22. POWER Indicator
Illuminated when the IFR 6000 is operational.
- 23. INTERR Indicator
Illuminated when Test Set is generating an interrogation signal (XPDR Mode) or receives an Interrogation (TCAS Mode) signal.
- 24. REPLY Indicator
Illuminated when the Test Set receives a valid reply signal (XPDR Mode) or generates a reply (TCAS Mode) signal.
- 25. CONTRAST Key
Displays/exits the Contrast Adjust Field.
The INCREMENT/SELECT Data Key or the DECREMENT/SELECT Data Key may be used to adjust the Contrast.

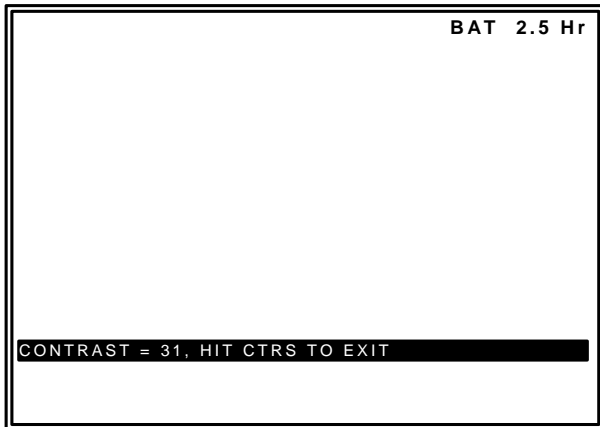

- 26. DECREMENT/SELECT Data Key
Decrements data in slewable fields, such as RF LVL. This Key also selects data in fields that have fixed functions, such as ECHO and SQUITTER.

ITEM DESCRIPTION

- 27. SELECT DATA UNIT MSB Key
Moves the slew cursor toward the MSB (Most Significant Bit) of the data field.
Example: When DME or TCAS range is selected, the slew cursor can be moved from the 1.0 nm unit to the 10 nm, 0.1 nm or 0.01 nm unit.
- 28. SELECT DATA UNIT LSB Key
This Key moves the slew cursor toward the LSB (Least Significant Bit) of the data field.
Example: When DME or TCAS range is selected, the slew cursor can be moved from the 1.0 nm unit to the 10 nm, 0.1 nm or 0.01 nm unit.
- 29. INCREMENT/SELECT Data Key
Increments data in slewable fields, such as RF LVL. This Key also selects data in fields that have fixed functions, such as ECHO and SQUITTER.
- 30. GPS Connector
BNC Type Connector used for connection to the IFR 6000 for over the air testing.
- 31. ANT Connector
TNC Type Connector used for connection to the IFR 6000 for over the air testing.
- 32. AUX OUT Connector 1
ATCRBS interrogation trigger used for calibration.
- 33. AUX OUT Connector 2
ATCRBS interrogation trigger used for calibration.
- 34. AUX OUT Connector 3
BNC type connector serves as the SYNC connector and provides synchronization pulses for each test set transmission, e.g., interrogation, reply, squitter.
- 35. AUX OUT Connector 4
Not Used.
- 36. USB HOST Connector
USB Flash Drive interface for software update.
- 37. USB DEVICE Connector
Not Used.

ITEM	DESCRIPTION
38.	ALTITUDE ENCODER Connector Interface for external encoding altimeter.
39.	AUX IN Connector Not Used
40.	RS-232 Connector Used for remote control interface, software update and test data dump.
41.	REMOTE Connector Used to interface with the IFR 6000.

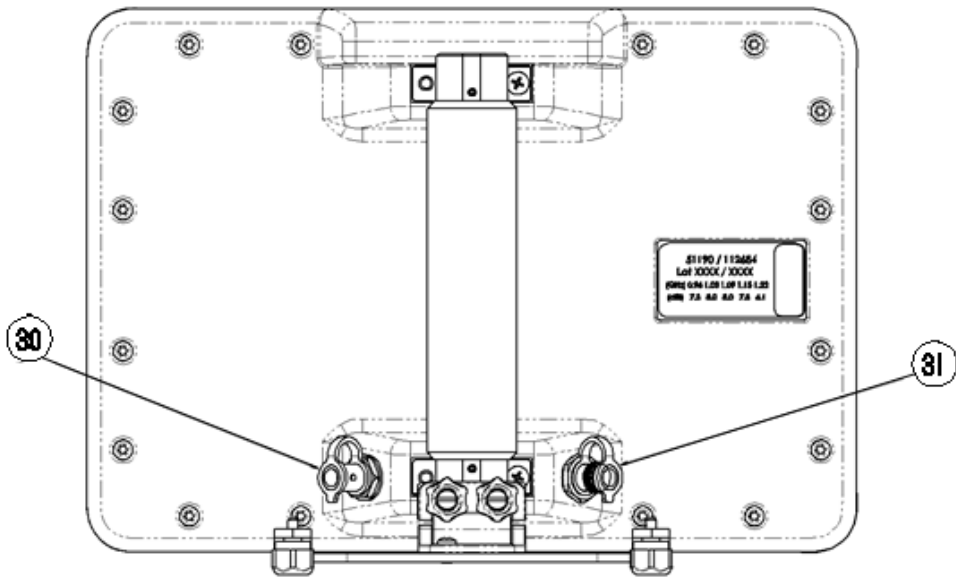

Directional Antenna
Figure 2

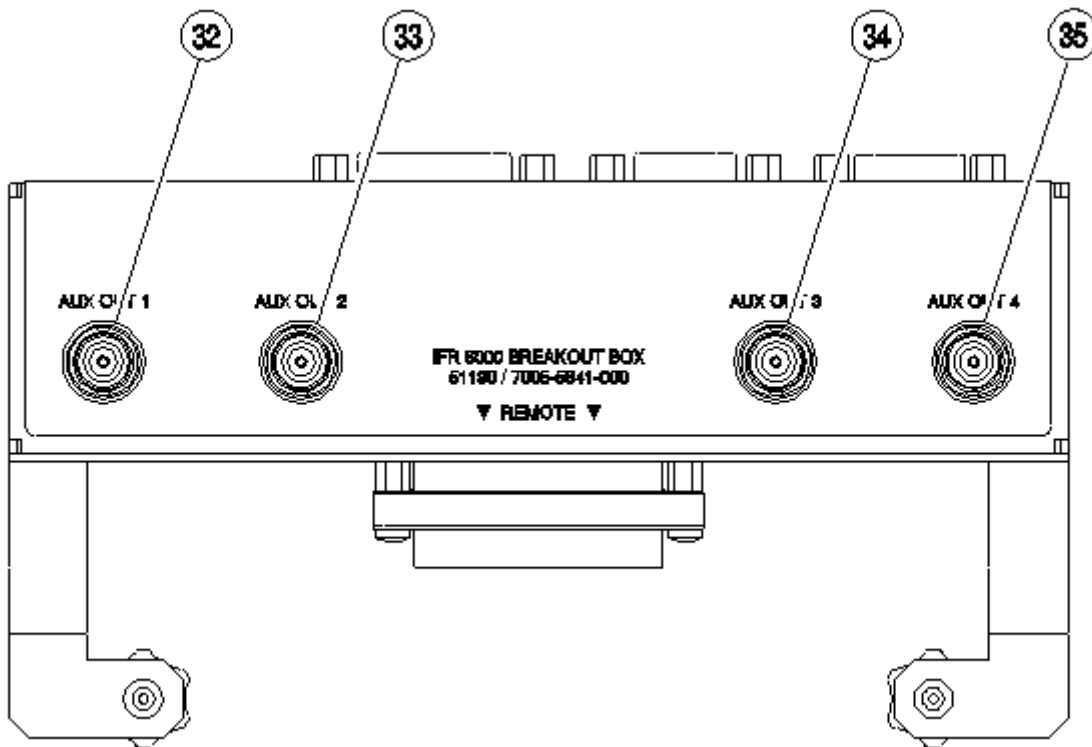

Breakout Box - Front View
Figure 3

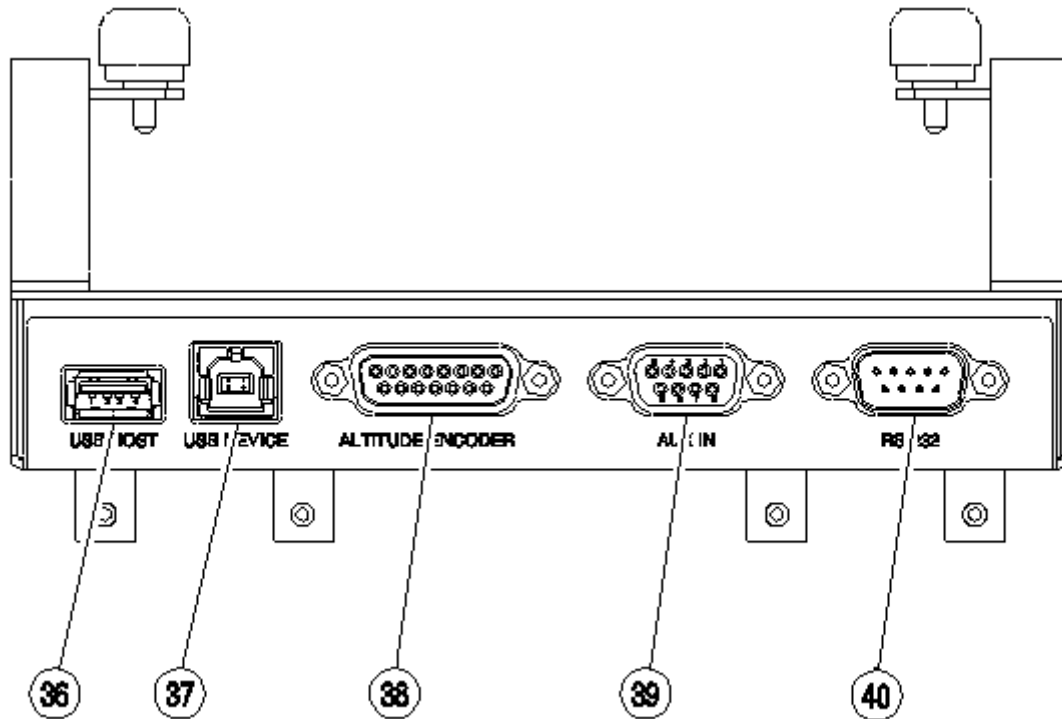

Breakout Box - Top View
Figure 4

06821A

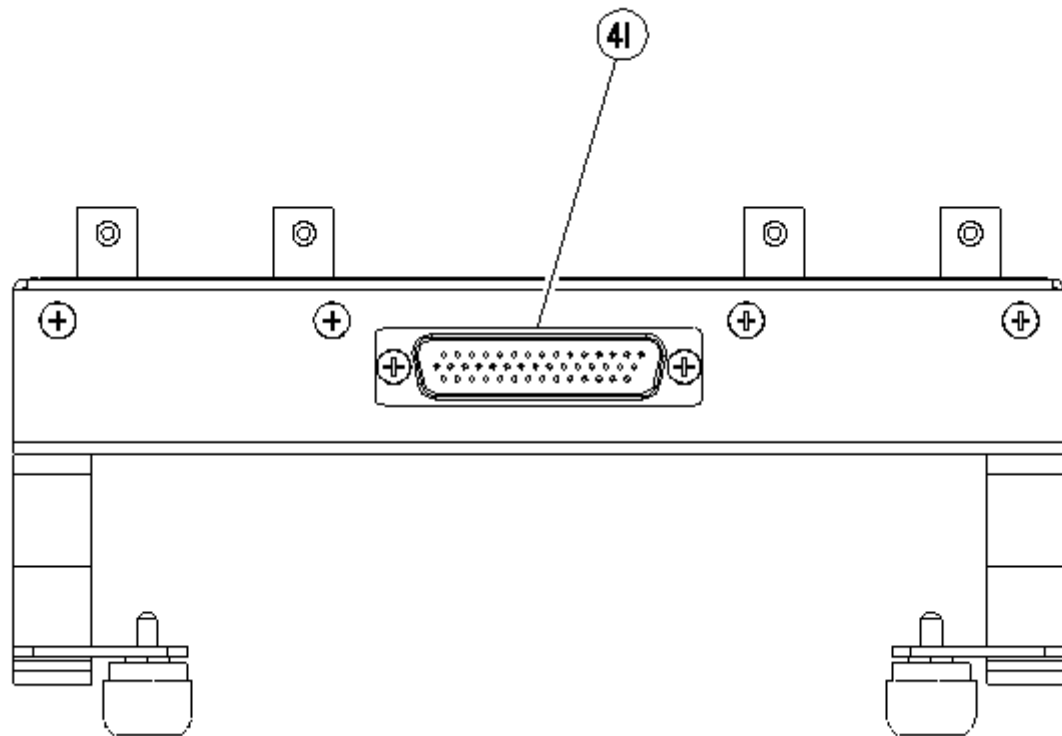

Breakout Box - Bottom View
Figure 5

06821B

THIS PAGE INTENTIONALLY LEFT BLANK.

3. PERFORMANCE EVALUATION

3.1 GENERAL

The IFR 6000 is equipped with a Self-Test for quick performance evaluation. An abbreviated Self-Test is run at Power-Up. The full Self-Test is initiated manually.

Refer to 1-2-2, Figure 1 for location of controls, connectors, and indicators.

3.2 START-UP SELF TEST

STEP	PROCEDURE
------	-----------

1. Press the POWER Key to power the Test Set On. The VIAVI Logo Screen will appear, followed by the POWER-UP SELF TEST Screen.

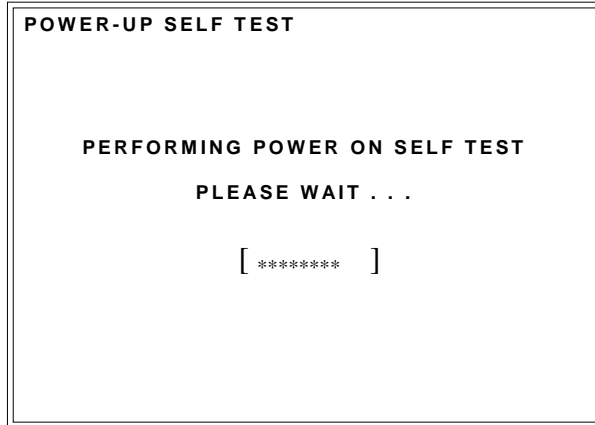

2. If the self-test fails, the SETUP SELF TEST Screen automatically appears. The SETUP SELF TEST Screen will indicate which functions have failed or passed the test.

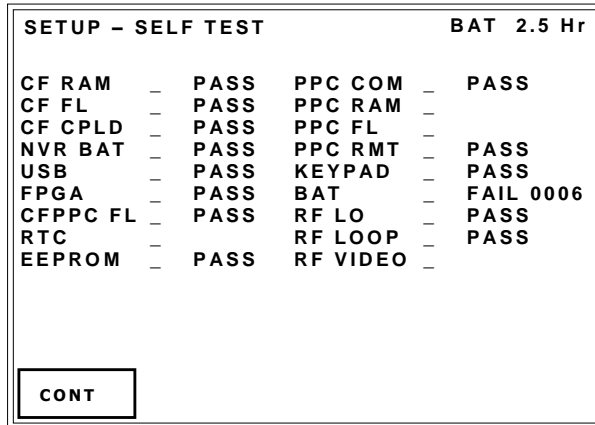

3. If the self-test does not detect any failed functions in the test set, the XPDR AUTO TEST Screen will appear.

XPDR-AUTO TEST		PASS		BAT 2.5 Hr	
CONFIG:GENERIC MODE S				LEVEL=4	
ANTENNA: BOTTOM					
REPLIES =A,C,S		FREQ =1090.12 MHZ			
TOP ERP =57.1 dBm		MTL =-74.0 dBm			
BOT ERP =56.0 dBm		MTL =-73.1 dBm			
A CODE =1234		C ALT =35000 ft			
S CODE =1234		S ALT =35000 ft			
TAIL =N12345		DF17 DETECTED=NO			
FLT ID =AA-50		AA=AC3421(53032041)			
FS=5-NO ALERT		SPI IN AIR			
VS=IN AIR		COUNTRY=United States			
RUN TEST		TEST LIST		CONFIG	
				SELECT ANT	

3.3 Calibration

STEP PROCEDURE

1. Press CAL Soft Key to display the Calibration Screen. Consult maintenance manual for required password.

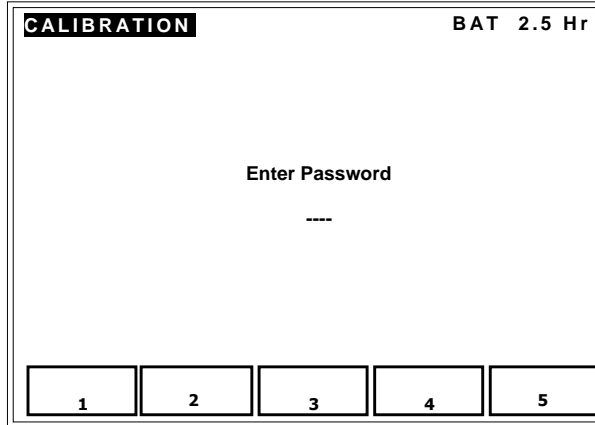

3.4 RS-232 SETUP

STEP PROCEDURE

1. Press RS232 Soft Key to display the RS-232 Screen.

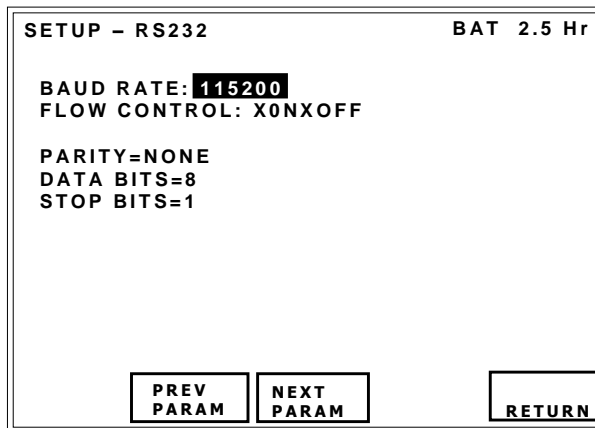

3.5 MANUAL SELF TEST

STEP PROCEDURE

1. Press SETUP Key until the Setup-General Screen is displayed.

SETUP - GENERAL		BAT 2.5 Hr	
PWR DOWN : 10 mins			
ERP UNITS : dBm		UNITS : METERS	
REMOTE OPERATION : RS232			
ANTENNA TYPE : OLD 7005-5840-500			
PREV PARAM	NEXT PARAM	H/W TOOLS	INFO

2. Press H/W TOOLS Soft Key to display the Hardware Tools Screen.

SETUP - HARDWARE TOOLS		BAT 2.5 Hr	
S/N 103009999			
MULTI-FUNCTION BOARD REV 0			
RF BOARD REV 0			
CPU BOARD REV 0			
RS232	SELF TEST	CAL	RETURN

3. Press Self-Test Soft Key to display the Self-Test Screen.

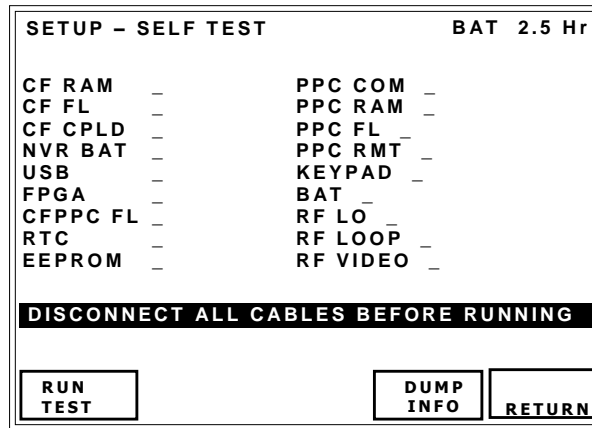

4. Press RUN TEST Soft Key to initiate the Self-Test.
5. Verify that all the modules/assemblies pass the Self-Test. If the Self-Test indicates a failure, contact VIAVI Customer Service for additional information:

Contact Information

Contact the Technical Assistance Center (TAC) for technical support or with any questions regarding this or other VIAVI products.

- Phone: 1-844-GO-VIAVI
- Email: Techsupport.Avcomm@viavisolutions.com

For the latest TAC information, go to:

<https://www.viavisolutions.com/support/technical-product-support>

THIS PAGE INTENTIONALLY LEFT BLANK.

4. OPERATING PROCEDURES

4.1 GENERAL

This section contains operating instructions for the IFR 6000. The IFR 6000 tests ATCRBS/MODE S Transponders, DME, TCAS, ADS-B, TIS, TIS-B, and UAT. The IFR 6000 replaces the IFR ATC-600A, ATC-601 and TCAS-201.

General procedures identify the controls, connectors, indicators, and display screens used in individual test modes. For specific Unit Under Test (UUT) Procedures, refer to the UUT Manual.

Refer to 1-2-2 for location of controls, connectors, and indicators.

The IFR 6000 Test Set provides ATCRBS/Mode S Transponder and DME Test capability as standard modes.

Software options available are:

- TCAS I, II, TAS, TIS (Traffic Information Service) and TIS-B (Traffic Information Service Broadcast).
- ADS-B (DO-260/A/B) and GICB extracted DAP's (Downlinked Aircraft Parameters).
- UAT (ADS-B monitor; FIS-B, TIS-B, and ADS-B generator.)

The IFR 6000 uses five functional modes:

XPDR MODE

XPDR Mode provides flight line test capability for ATCRBS and Mode S transponders using an Auto Test, a series of tests displayed over several screens. All data normally required to verify transponder operation in accordance with FAR 91.413, Part 43, Appendix F, is displayed on one main Auto Test Screen.

Different classes of transponders are tested to built-in test limits by selection of configuration files. If the class of transponder is unknown, generic configuration files are provided for ATCRBS and Mode S transponders that apply the widest system limits.

Mode S Transponder level is automatically determined. European Enhanced Surveillance test capability allows decode and display of GICB derived BDS register contents (primary parameters only).

ADS-B provides flight line test capability for receiving, decoding and displaying full DO-260/A/B DF17 extended squitter transmissions from Mode S transponders or DF18 extended squitters from 1090 MHz emitters. Capability to generate full DO-260/A/B DF17/18 extended squitter transmissions for testing ADS-B receivers is provided. A GICB mode decodes and displays all Enhanced Surveillance BDS register contents.

NOTE: ADS-B operates as an XPDR submode.

DME MODE

DME Mode provides flight line test capability for Distance Measuring Equipment Interrogators. All parameters normally required for DME testing are displayed on one main screen. UUT interrogation parameters are clearly displayed in conjunction with Test Set reply parameters.

TCAS MODE

TCAS Mode provides flight line test capability for TCAS I, II and TAS. ATCRBS and Mode S intruders are simulated, allowing the generation of proximity, TA and RA flight deck annunciations. TCAS Interrogator parametric measurements are displayed.

TIS Provides a five aircraft static flight simulation, using the Comm A protocol, to test the TIS (Traffic Information Service).

TIS-B provides a five aircraft static flight simulation, using DF18 extended squitter broadcasts, for testing TIS-B (Traffic Information Service Broadcast) systems.

NOTE: TIS and TIS-B operate as TCAS sub modes.

NOTE: TIS-B is not provided in the second release of the TCAS option.

UAT MODE

UAT Mode provides capability to monitor ADS-B messages and generate FIS-B, TIS-B, and ADS-B messages.

SETUP MODE

SETUP Mode function sets various parameters used in testing, configuration, and memory storage for each functional mode.

4.2 START-UP

Press POWER Key. Start-Up Screen appears on the DISPLAY. XPDR-Auto Test Screen with blank data fields always displays on Power-up.

STEP	PROCEDURE
------	-----------

Software Update Procedure Via USB:

1. Software must be loaded onto a FAT 32 USB Flash Drive. Software updates may be downloaded from <https://www.viavisolutions.com/en-us/software-download/ifr6000-software>. Note: only one version of software may reside on the root directory of the Flash Memory stick.

NOTE: Software versions below 2.02 use FAT 16.

2. Connect IFR 6000 breakout box to IFR 6000. Insert USB Flash Drive in USB port and Press Power key to power unit. Software load process is automatic.
3. When software load is complete, remove USB Flash Drive.

4.3 SET-UP GENERAL

The Setup General Screen contains parameters that determine the common operational characteristics of each functional mode of the Test Set.

SETUP - GENERAL		BAT 2.5 Hr	
PWR DOWN :	10 mins	ERP UNITS :	dBm
		UNITS :	METERS
REMOTE OPERATION :	RS232		
ANTENNA TYPE :	7005-5840-500		
PREV PARAM	NEXT PARAM	H/W TOOLS	INFO

STEP	PROCEDURE
------	-----------

1. Press SETUP Select Key until SETUP-GENERAL Screen is displayed.
2. Set following parameters by pressing NEXT PARAM and PREV PARAM to select the field. Use DATA Keys to slew data.
 - PWR DWN:
 - Selects battery saving power down time in minutes, ranging from 5 to 20 min or OFF.
 - ERP UNITS:
 - Selects ERP units in dBm, dBW or WATTS (peak).
 - UNITS:
 - Selects Setup XPDR Screen distance units in feet or meters.
 - REMOTE OPERATION:
 - Selects Remote Operation type of RS-232 or OFF.
 - ANTENNA TYPE:
 - Selects old or new antenna:
 - 7005-5840-500
 - 91771
 - 112684 with GPS
3. Press XPDR Mode Key to return to XPDR Auto Test Screen.

Note: Press the INFO Key to navigate to the SETUP-CONFIG INFO screen where the Firmware Versions and Options are displayed.

4.4 XPDR (TRANSPONDER)

Press XPDR Mode Key to select XPDR Functional Mode. XPDR Auto Test Screen is displayed

```

XPDR-AUTO TEST      PASS      BAT 2.5 Hr

CONFIG:GENERIC MODE S      LEVEL=4
ANTENNA:BOTTOM

REPLIES =A,C,S      FREQ =1090.12 MHZ
TOP ERP =57.1 dBm    MTL  =-74.0 dBm
BOT ERP =56.0 dBm    MTL  =-73.1 dBm
A CODE  =1234      C ALT =35000 ft
S CODE  =1234      S ALT =35000 ft
TAIL    =N12345    DF17 DETECTED=NO
FLT ID  =AA-50     AA=AC3421(53032041)
FS=5-NO ALERT      SPI   IN AIR
VS=IN AIR          COUNTRY=United States

[RUN TEST] [TEST LIST] [CONFIG] [SELECT ANT]
    
```

There are two versions of the Auto Test Screen, one for ATCRBS transponders and one for Mode S transponders. The number of additional screens displayed by the Test List feature depends on the configuration selected.

4.4.1 CONFIGURATIONS

Press CONFIG Soft Key to display CONFIG List. Use DATA Keys to select the desired configuration. Press RETURN Soft Key to display XPDR Auto Test Screen.

```

XPDR - CONFIG      BAT 2.5 Hr

1  GENERIC ATCRBS
2  ATCRBS CLASS A
3  ATCRBS CLASS B
4  GENERIC MODE S
5  MODE S CLASS A
6  MODE S CLASS B
7  MODE S CL B OPT FREQ
8  MODE S CL B OPT PWR

[INFO] [RETURN]
    
```

Eight predefined Configurations are provided to determine the PASS/FAIL limits applied to ERP, Frequency and MTL measurements. Configurations are named by class and option. Refer to Appendix F for predefined Configuration details

NOTE: Transponder class and option identification are found on the transponder's TSO label.

1. GENERIC ATCRBS: Tests ATCRBS transponders, specifically when the class of the transponder is unknown.
2. ATCRBS CLASS A: Tests ATCRBS Class A transponders.
3. ATCRBS CLASS B: Tests ATCRBS Class B transponders.
4. GENERIC MODE S: Tests Mode S transponders, specifically when the class of the transponder is unknown.
5. MODE S CLASS A: Tests Mode S Class A transponders.
6. MODE S CLASS B: Tests Mode S Class B transponders.
7. MODE S CL B OPT FREQ: Tests Mode S Class B transponders equipped with Class A frequency tolerance option.
8. MODE S CL B OPT PWR: Tests Mode S Class B transponders equipped with Class A power option.

NOTE: Level detection is automatic when running a test.

Press INFO Soft Key to display XPDR INFO Screen. XPDR INFO Screen displays the PASS/FAIL limits for selected Configuration.

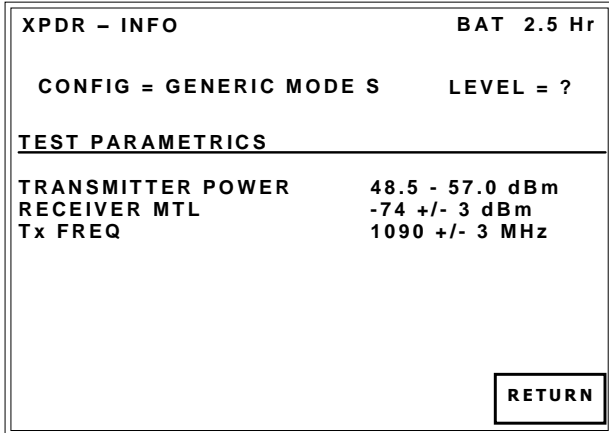

4.4.2 SETUP

SETUP XPDR

Setup XPDR Screen contains parameters which determine operational characteristics of the XPDR Functional Mode. Unless otherwise stated, last used values are retained on Power-up.

NOTE: Enter Setup Screen information before conducting test operations.

NOTE: UAT will use the port selection, antenna setup, and cable characteristics from the XPDR setup.

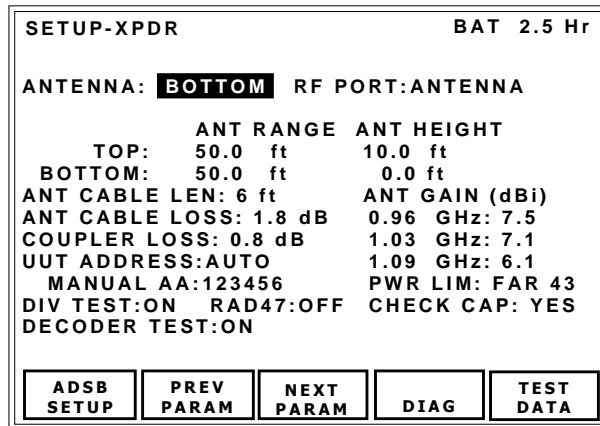

STEP PROCEDURE

1. Press SETUP Soft Key to display SETUP-XPDR Screen.
2. Set the parameters by pressing NEXT PARAM. Press PREV PARAM to select the field. Use DATA Keys to slew the data. Parameters are:
 - ANTENNA:
TOP or BOTTOM
 - RF PORT:
Selects ANTENNA (ANT CONNECTOR) or DIRECT CONNECT via RF I/O Connector or DIR W/COUPLER.
 - ANT CABLE LEN or DIR CABLE LEN or CPL CABLE LEN:
Selections: 1 to 75 FT.
 - ANT CABLE LOSS or DIR CABLE LOSS or CPL CABLE LOSS:
Displays cable loss in dB (at 1090 MHZ). Figure marked on supplied RF coaxial cable
CABLE LOSS field is automatically calculated. Cable loss may be manually entered by the user.

STEP	PROCEDURE
	<p>NOTE: Cable loss range 0.0 to 9.9 dB.</p> <p>Cable Len will automatically calculate cable loss in dB. Cable loss is automatically displayed.</p> <p>NOTE: Based on VIAVI supplied cables, (25- and 50-foot cables optional)</p> <p>NOTE: 25- and 50-foot cable selection compensates for delay of VIAVI optional cables.</p> <p>NOTE: To calculate cable length to enter, for non-VIAVI supplied cables, use the following formula.</p> <p style="padding-left: 20px;">Lentered = L * (0.68/V)</p> <p style="padding-left: 20px;">L = physical length of cable</p> <p style="padding-left: 20px;">V = Velocity factor of cable</p> <p style="padding-left: 20px;">Where Lentered = the length value entered into ANT/DIR/CPL CABLE LEN field.</p> <ul style="list-style-type: none"> ● COUPLER LOSS: Displays coupler loss in dB (at 1090 MHZ). Figure marked on supplied coupler. <p>NOTE: Coupler loss range 0.0 to 9.9 dB.</p> <ul style="list-style-type: none"> ● ANT GAIN: Entered in dBi, gain figures for 960, 1030 and 1090 MHz marked on supplied Directional Antenna. <p>NOTE: Antenna gain range 0.0 to 20.9 dB.</p> <ul style="list-style-type: none"> ● ANT RANGE: Test Set Antenna to transponder antenna horizontal range. Enter parameters for BOTTOM and TOP antenna if installation has diversity capability. <p>NOTE: Antenna Range is 6 to 250 ft or 2.0 to 75.0 m. UNITS parameter on SETUP-GENERAL Screen determines feet or meters.</p>

STEP	PROCEDURE
	<ul style="list-style-type: none"> ● PWR LIM: FAR 43 OR MOD43. FAR 43 uses limits in accordance with FAR 91.413, Part 43, Appendix F. MOD 43 removes upper ERP limits and lower MTL limits. ● CHECK CAP: YES or NO. If YES (default) is selected, BDS 1,7/1,8/1,9 is verified to confirm availability of (DO-260A & DO-260B Only): <p style="padding-left: 20px;">BDS 0,5 BDS 0,6 BDS 0,7 BDS 0,8 BDS 0,9 BDS 1,D BDS 1,E BDS 1,F BDS 2,0 BDS 2,1 BDS 3,0 BDS 4,0 BDS 4,1 BDS 4,2 BDS 4,3 BDS 5,0 BDS 6,0 BDS 6,1 BDS 6,2 BDS 6,5</p> <p>If BDS 1,7/1,8/1,9 reports a particular BDS is not available, the data is blanked alongside the respective BDS in the Enhanced Surveillance Screen, or GICB screens.</p> <p>If NO is selected, BDS 1,7/1,8/1,9 is not verified, and the Test Set will extract the BDS and display content.</p> <p>NOTE: Some transponders reply to BDS requests even though BDS 1,7/1,8/1,9 reports they are not available.</p> <p>NOTE: Check Cap changes to NO when any ATRBS mode is selected.</p>

STEP PROCEDURE

- **UUT ADDRESS:**
 MANUAL or AUTO (defaults to AUTO on power-up). AUTO selection Mode S address is obtained via ATCRBS/Mode S All Call (FAR Part 43, Appendix F approved method).
 On loss of ATCRBS/Mode S All Call reply (i.e., UUT placed in ground state) tests already running continue to use last ATCRBS/Mode S All Call obtained address. AUTO uses manually entered address if no reply is received.

NOTE: ICAO amendment 77 transponders only replies to Mode S discrete interrogations when installation is in ground state.

- **MANUAL ADDRESS:**
 A six-digit HEX address is entered if UUT ADDRESS: MANUAL is selected.
- **DIVERSITY TEST:**
 ON or OFF. If testing transponders with single antenna systems, select OFF.
NOTE: If Diversity Isolation Test is enabled, ensure Antenna Shield is fitted to top or bottom UUT antenna prior to running test. Refer to Appendix J for Antenna Shield mounting procedure.
- **RAD47:**
 ON or OFF.
NOTE: RAD47 is an Australian directive for civil aviation where the reply pulse width is between 0.35 to 0.55 us and amplitude variation (droop) is not greater than 1dB. Set to ON if applicable.
- **DECODER TEST:**
 ON or OFF. When OFF, the Decoder Test is not run.

3. Press XPDR Mode Key to return to XPDR Auto Test Screen.

SETUP TEST DATA

The Setup Test Data Screen allows storage and recall of all transponder test screens, including measurement data. There are twelve storage memories. The first storage memory retains the last power down data and cannot be overwritten. The last five may be defined by the Test Set operator. If the operator does not enter a name the Mode S Transponder Address, Date and Time are automatically entered on storage, i.e., 400D5F 10/10/05 13:43:16.

SETUP - TEST DATA		BAT 2.5 Hr		
1	Last power-down			
2	ATC 10/5/05 12:45:13			
3	400D5F 10/10/05 13:43:16			
4				
5				
6				
7				
8				
9				
10				
11				
12				
STORE		RECALL	DUMP STORE	DUMP LIVE
RETURN				

CONFIRM		BAT 2.5 Hr		
Overwrite existing store?				
YES		NO		

STEP

PROCEDURE

SETUP - STORE NAME		BAT 2.5 Hr	
A BCDEFGHIJKLMNOPQRSTUVWXYZ abcdefghijklmnopqrstuvwxyz 023456789 ! " () * , - . / : ; ? @ _ <u>400D5F 10/10/05 13:43:06</u> Please enter store name			
ENTER	CHAR SELECT	BACK SPACE	CANCEL

Data Storage Procedure:

1. Press SETUP Select Key to display SETUP - XPDR Screen. Press TEST DATA Soft Key to display SETUP TEST DATA Screen.
2. Use DATA Keys to select the required store.
3. Press STORE Soft Key. A confirm Screen is displayed. Press YES Soft Key to confirm overwrite. SETUP STORE NAME Screen is displayed. Software always prompts for overwrite. Store name can be blank.
4. Use DATA Keys to select the character line. Use DATA Keys to select desired character.
5. Press CHAR SELECT Soft Key to add selected character to the end of name string. Press BACK SPACE Soft Key to delete the selected character.
6. When name is complete, press ENTER Soft Key to store name and display SETUP TEST DATA Screen.
7. Press XPDR Mode Key to return to XPDR-Auto Test Screen.

STEP

PROCEDURE

Data Recall Procedure:

1. Press SETUP Select Key until SETUP - XPDR Screen is displayed. Press TEST DATA Soft Key to display SETUP TEST DATA Screen.
2. Use DATA Keys to select required store.
3. Press RECALL Soft Key to recall test data.
4. Press XPDR Mode Key to return to XPDR Auto Test Screen.

RS232 Data Dump Procedure:

1. Press SETUP Select Key until SETUP - XPDR Screen is displayed. Press TEST DATA Soft Key to display SETUP TEST DATA Screen.
2. Use DATA Keys (Increment/Select, Decrement/Select), to select and slew data.
3. Ensure that RS-232 interface parameters are set correctly for communication with PC.
4. Press DUMP STORE Soft Key to send selected stored test data to the PC via the RS-232 interface.
5. Press DUMP LIVE Soft Key to send current or live test data to PC via the RS-232 interface.
6. Press XPDR Mode Key to return to XPDR Auto Test Screen.

4.4.3 AUTO TEST

Introduction:

XPDR Auto Test contains one main screen (the Auto Test Screen) and up to 19 additional test screens. Auto Test completes a full FAR Part 43, Appendix F Test, providing decode and display of Elementary and Enhanced surveillance GICB extracted DAP's (Downlinked Aircraft Parameters).

When first powered-up the Test Set displays blank data fields. The last test results are displayed while Test Set remains powered on. The last test results are stored upon power-down.

Auto Test only displays items needed to visually confirm a FAR Part 43 Test. For detailed test explanations, refer to TEST DETAILS for individual test list screens.

General Description:

Mode Test

Mode Test Identifies modes of operation. Mode Test interrogates with Mode A, Mode C and ATCRBS (Mode C)/Mode S All-Call to determine reply modes of the transponder. Mode A, Mode C and ATCRBS (Mode C)/Mode S All-Call modes are tested during Auto Test sequence.

NOTE: Internal to software. No screen is displayed.

Transponder Level

Transponder Level is automatically determined by requesting a BDS 1,0 Data Link Capability Report. Transponder level is displayed on Auto Test Screen.

Mode S UF Tests Run, based on XPDR Level:

Level 1: UF0,4,5,11,16,20,21

Level 2: UF0,4,5,11,16,20,21

Level 3: UF0,4,5,11,16,20,21, (24 UELM)

Level 4: UF0,4,5,11,16,20,21, (24 UELM)

STEP	PROCEDURE
------	-----------

1. Follow CONFIG selection procedure (1-2-4.3.1).
2. Press SELECT ANTENNA Soft Key to select TOP or BOTTOM antenna to be tested. Antenna selected in XPDR Setup Screen is displayed by default.

XPDR-AUTO TEST	BAT 2.5 Hr
CONFIG:MODE S CL B OPT POW LEVEL=	
ANTENNA: TOP	
REPLIES =	FREQ = MHZ
TOP ERP =	MTL = dBm
BOT ERP =	MTL = dBm
A CODE =	C ALT = ft
S CODE =	S ALT = ft
TAIL =	DF17 DETECTED=
FLT ID =	AA=
FS=	
VS=	COUNTRY=
TEST 1/19	*TESTING*
STOP TEST	

3. Press RUN TEST Soft Key to start Auto. TEST RUNNING is displayed at top of screen.

XPDR-AUTO TEST	PASS	BAT 2.5 Hr
CONFIG:GENERIC MODE S LEVEL=4		
ANTENNA: BOTTOM		
REPLIES = A,C,S	FREQ = 1090.12 MHZ	
TOP ERP = 57.1 dBm	MTL = -74.0 dBm	
BOT ERP = 56.0 dBm	MTL = -73.1 dBm	
A CODE = 1234 ID	C ALT = 35000 ft	
S CODE = 1234	S ALT = 35000 ft	
TAIL = N12345	DF17 DETECTED=NO	
FLT ID = AAA50	AA=AC3421(53032041)	
FS=5-NO ALERT	SPI IN AIR	
VS=IN AIR	COUNTRY=United States	
RUN TEST	TEST LIST	CONFIG
		SELECT ANT

STEP	PROCEDURE
4.	Auto Test completes and displays Parameters tested. Warnings/Errors are identified by an arrow symbol to left of the item.

The Parameters displayed are:

Regulatory Test Requirements

TESTS IDENTIFIER SYMBOLS	
◆	FAA FAR 91.413, Part 43, Appendix F
●	Other Civil Aviation Authority Requirement
♣	Eurocontrol/JAA (Proposed)

Test Identifier Symbols
Table 1

Auto Test Details:

◆REPLIES: Transponder Modes replied to A, C, S

◆FREQ: Transponder TX frequency in MHz

◆TOP ERP: Top transponder antenna Effective Radiated Power in dBm, dBW or peak

NOTE: Units selected in SETUP-GENERAL Screen.

◆TOP MTL: Top transponder antenna Minimum Trigger Level

◆BOT ERP: Bottom transponder antenna Effective Radiated Power in dBm, dBW or peak.

NOTE: Units selected in SETUP-GENERAL Screen.

◆BOTTOM MTL: Bottom transponder antenna Minimum Trigger Level

◆A CODE: Mode A 4096 squawk code. Presence of Ident (SPI) pulse indicated by display of 'ID' after the squawk code.

◆S CODE: Mode S 4096 Identity Code. Presence of Ident (SPI) pulse indicated by display of 'ID' after the squawk code (obtained from DF5)

NOTE: The Mode A code is compared with Mode S code. Modes A and S codes Pass when in agreement.

STEP	PROCEDURE
------	-----------

◆C ALT: Mode C altitude displayed (100 ft resolution)

◆S ALT: Mode S altitude displayed (25- or 100-foot resolution, obtained from DF4)

NOTE: Mode C altitude is compared to Mode S altitude. Modes C and S altitudes Pass when in agreement of 100 ft.

◆TAIL: Aircraft tail number decoded from Mode S discrete address (obtained from Mode S All Call DF11)

NOTE: Some countries have encoded the aircraft tail number into the Mode S discrete address. Refer to Appendix G for list of countries supported. If not supported only the country is displayed.

COUNTRY: Decoded from the Mode S discrete address (obtained from Mode S All Call DF11).

DF17 DETECTED: Indicates the presence of DF17 extended squitter.

NOTE: ADS-B option is required to decode and display DF17 squitter content.

♣FLT ID: Eight Character ICAO Flight ID

◆AA: Aircraft Address (Mode S discrete address) displayed in HEX and (OCTAL)

♣FS: Flight Status. The number preceding the text identifies the RTCA DO-181C FS code assignment. Indications are:

ALERT, NO ALERT, SPI, NO SPI, AIRBORNE, ON GROUND (obtained from DF0).

♣VS: Vertical Status either ON GND or IN AIR (obtained from DF0)

Testing FS (Flight Status) and VS (Vertical Status):

ICAO Amendment 77 transponders only reply to Mode S discrete interrogations when installation is in ground state. Refer to Setup for UUT ADDRESS settings (para 1-2-4.4.2).

STEP PROCEDURE

Auto Test Screen examples:

ATCRBS CLASS B configuration selected with FAIL indication (Only ATCRBS parameters displayed).

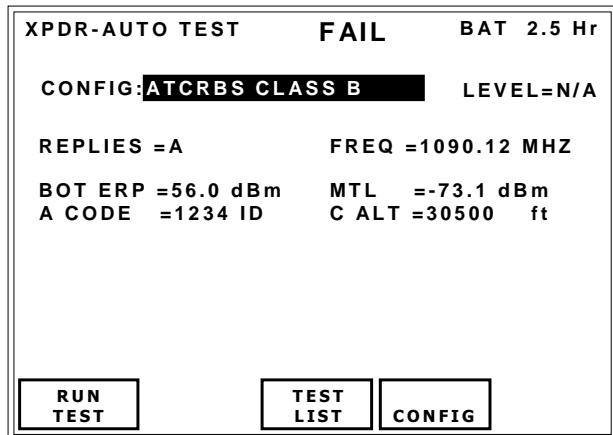

GENERIC ATCRBS configuration selected with NO REPLY indication (No Reply from Transponder).

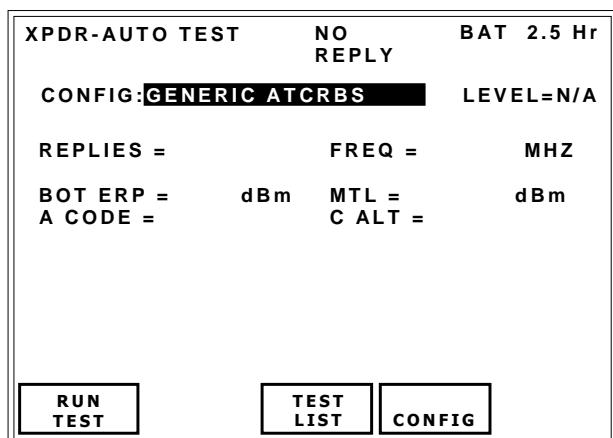

4.4.4 TEST LIST

Introduction:

Auto Test Screen is the primary test screen. The complete Auto Test contains up to 19 additional test screens.

The Test Set displays blank data fields when first powered-up. While the Test Set remains powered the last test results are displayed.

STEP PROCEDURE

1. Press TEST LIST Soft Key to display Test List. When a Mode S configuration is selected the test list is displayed over two screens. When an ATCRBS configuration is selected the test list is displayed on one screen
2. Use DATA Keys to select desired test. Press SELECT TEST Soft Key to display selected test.
3. Press RUN TEST Soft Key to start test.
4. Press STOP TEST Soft Key to stop test.
5. Press NEXT TEST Soft Key to display the next test.
6. Press PREV TEST Soft Key to display the previous test.
7. Press RETURN Soft Key to display the test list and choose desired test.

NOTE: The test runs until stopped. Each pass through the test sequence updates the PASS/FAIL indication.

```

XPDR - TEST LIST                                BAT 2.5 Hr
1  A/C DECDR/SLS                               - PASS
2  A/C F1/F2 SPACE/WIDTH                       - PASS
3  MODE A DURATION/AMP                         - PASS
4  MODE C DURATION/AMP                         - PASS
5  POWER/FREQ                                  - PASS
6  S ALL-CALL                                  - PASS
7  S REPLY TIMING                             - PASS
8  S REPLY                                     - PASS
9  UF0                                          - PASS
10 UF4                                         - PASS
11 UF5                                         - PASS
12 UF11                                        - PASS

```

SELECT TEST NEXT PAGE RETURN

```

XPDR-A/C DECDR/SLS  PASS  BAT 2.5 Hr
DECODER INNER LOW   A=PASS   C=PASS
DECODER INNER HIGH  A=PASS   C=PASS
DECODER OUTER LOW   A=PASS   C=PASS
DECODER OUTER HIGH  A=PASS   C=PASS
SLS 0 dB            A=PASS   C=PASS
SLS -9 dB           A=PASS   C=PASS

```

A CODE = 2620 IDENT
A4 A2 A1 B4 B2 B1 C4 C2 C1 D4 D2 D1

C ALT = 100000 ft
A4 A2 A1 B4 B2 B1 C4 C2 C1 D4 D2

RUN TEST PREV TEST NEXT TEST RETURN

```

XPDR - TEST LIST                                BAT 2.5 Hr
8  S REPLY                                     - PASS
9  UF0                                          - PASS
10 UF4                                         - PASS
11 UF5                                         - PASS
12 UF11                                        - PASS
13 UF16                                        - PASS
14 UF20                                        - PASS
15 UF21                                        - PASS
16 UF24                                        - PASS
17 ELEMENTARY SURV 1                         - PASS
18 ELEMENTARY SURV 2                         - PASS
19 ENHANCED SURV                             - PASS

```

SELECT TEST PREV PAGE RETURN

XPDR A/C Decoder/SLS Test

XPDR A/C Decoder/SLS Test performs these functions:

- ◆ Verifies inner and outer windows for Mode A and C interrogations
- ◆ Verifies the SLS performance for Mode A and C interrogations
- ◆ Displays Mode A Squawk Code, Ident (SPI) and code binary bits.
- ◆ Decodes and displays the Mode C altitude in feet and code binary bits.

NOTE: Binary bits verify if specific control lines are correct.

Decoder

The Test Set interrogates with valid Mode A and C interrogations, +6 dB above MTL.

Nominal spacing, P1 to P3, 8 μ s for Mode A and 21 μ s for Mode C. The test deviates the pulse spacings as follows:

Decoder Inner Low sets P1 to P3 pulse spacing to inner high "must reply" values (8.2 μ s for Mode A and 21.2 μ s for Mode C). The test indicates PASS if percent replies are \geq 90% or FAIL if percent replies are $<$ 90%. An arrow identifies FAIL.

Decoder Inner High sets P1 to P3 pulse spacing to inner low "must reply" values (7.8 μ s for Mode A and 20.8 μ s for Mode C). The test indicates PASS if percent replies are \geq 90% or FAIL if percent replies are $<$ 90%. An arrow identifies FAIL.

```

XPDR - TEST LIST                                BAT 2.5 Hr
1  A/C DECDR/SLS                               - PASS
2  A/C F1/F2 SPACE/WIDTH                       - PASS
3  MODE A DURATION/AMP                         - PASS
4  MODE C DURATION/AMP                         - PASS
5  POWER/FREQ                                  - PASS

```

SELECT TEST RETURN

Decoder Inner Low sets P1 to P3 pulse spacing to outer high "must not reply" values (9.0 μ s for Mode A and 22 μ s for Mode C). The test indicates PASS if percent replies are \geq 10% or FAIL if percent replies are $<$ 10%. An arrow identifies FAIL.

Decoder Inner High sets P1 to P3 pulse spacing to outer low "must not reply" values (7.0 μ s for Mode A and 20 μ s for Mode C). The test indicates PASS if percent replies are \geq 10% or FAIL if percent replies are $<$ 10%. An arrow identifies FAIL.

SLS

The Test Set interrogates with Mode A and C interrogations including the P2 SLS pulse. When P2 level is set at -9 dB and replies are \geq 90%, the test indicates PASS. If replies are $<$ 90%, the test indicates FAIL.

When P2 level is set at 0 dB and replies are \geq 1%, the test indicates FAIL. If replies are \geq 1%, the test indicates PASS.

NOTE: Because interrogation with SLS at -9 dB is sent at MTL + 12 dB, the test must be run within 95 ft (28.96 m) of UUT antenna being tested.

A Code

The Test Set interrogates with Mode A interrogations, +6 dB above MTL. Replies are monitored and transponder Squawk code is displayed in four digit octal and binary. If Ident (SPI) is present in the reply, IDENT is displayed after the octal code.

C Altitude

The Test Set interrogates with Mode C interrogations, +6 dB above MTL. The replies are monitored, and transponder altitude code is displayed in feet to a resolution of 100 ft. Receiving an invalid input (no C bit or C1 and C4 are on at the same time) blanks out the altitude field. Regardless of validity, the Mode C information is shown in binary format (MSD to LSD):

A4, A2, A1, A, B4, B2, B1, B, C4, C2, C1, C, D4, D2.

Press Return to go back to the XPDR - TEST LIST, or NEXT TEST to perform the next test on the list.

XPDR-A/C SPAC/WDTH		FAIL	BAT 2.5 Hr
F1WIDTH	▶ A= 0.300 us	C= 0.450 us	
F2WIDTH	A= 0.400 us	▶ C= 0.600 us	
F1-F2	A=20.300 us	C=20.300 us	
REPLY DELAY	A=3.05 us	▶ C=3.55 us	
REPLY JITTER	A=0.250 us	C=0.000 us	
REPLY RATIO	A=100%	C=100%	
-81dBm REPLY RATIO	A=0%	C=0%	
ATCRBS ALL-CALL	A=PASS	C=PASS	
PULSE AMP VAR	A=0.0 dB	C=0.0 dB	
RUN TEST	PREV TEST	NEXT TEST	RETURN

XPDR A/C Spacing Width Test

XPDR A/C Spacing Width performs these functions:

- ◆ Verifies and displays F1/F2 pulse width and spacing for Mode A and C replies.
- ◆ Verifies and displays reply delay for Mode A and C replies.
- ◆ Verifies and displays reply jitter for Mode A and C replies.
- ♣ Verifies reply ratio for Mode A and C interrogations.
- ◆ Verifies replies to ATCRBS all call Mode A and C interrogations.
- ♣ Verifies Mode A and C reply pulse droop.

F1/F2 Pulse Width and Spacing

The IFR 6000 interrogates with Mode A and C interrogations, +6 dB above MTL. The test indicates F1 to F2 spacing, F1 width and F2 width values on the DISPLAY for Mode A and C replies. Measurements outside the following tolerances result in a FAIL and are identified by an arrow.

F1/F2 pulse widths are 0.45 μ s (\pm 0.10 μ s).

F1 to F2 spacing is 20.30 μ s (\pm 0.10 μ s).

Reply Delay

The Test Set interrogates UUT with Modes A and C. The test verifies reply delay minus range delay is 3.00 μ s (\pm 0.50 μ s).

Measurements outside the above tolerance result in a FAIL and are identified by an arrow.

Reply Jitter

The Test Set interrogates UUT with Modes A and C. The test verifies reply jitter values (difference between shortest and longest reply delay) using the best that are $\leq 0.1 \mu s$.

Measurements outside the above tolerance result in a FAIL and are identified by an arrow.

Reply Ratio

The Test Set interrogates UUT with Modes A and C. The test verifies replies are $\geq 90\%$ between MTL +6 dBm and not more than $\leq 10\%$ for -81 dBm. Replies outside this tolerance results in a FAIL and are identified by an arrow.

NOTE: Above paragraph only applicable to direct connect testing.

NOTE: Transponder occupancy in 'over the air testing' prevents reliable Reply Ratio measurements. When Antenna is selected, Reply Ratio Mode A and C Test displays percent replies however, PASS/FAIL test limits are not applied.

ATCRBS All Call

The Test Set interrogates with ATCRBS (Mode A and C) only All-Call interrogations, 6 dB above MTL. Test verifies the following: ATCRBS transponder must reply.

Mode S transponder must not reply in any mode.

Reply criteria is $\geq 90\%$. No Reply criteria is $\leq 10\%$. A FAIL is identified by an arrow.

NOTE: The selected configuration file determines if an ATCRBS or Mode S transponder is being tested.

Pulse Amplitude Variation

The Test Set interrogates with Mode A and C interrogations, +6 dB above MTL. The test verifies all pulses in the Mode A and C replies are within a 2 dB amplitude window (minimum to maximum). Replies outside the 2 dB window result in a FAIL indication and are identified by an arrow.

XPDR - POWER/FREQ				PASS	BAT 2.5 Hr
TX FREQ = 1090.12 MHz ANTENNA:TOP					
MEASURED VIA	TOP DIRECT	BOTTOM ANTENNA	INSTANT DIRECT		
MTL (dBm)					
ATCRBS	-73.2	-73.1	-73.2		
A-C DIFF	0.2	-0.1	0.0		
ALL CALL	-73.0	-73.2	-73.2		
MODE S	-73.2	-72.9	-73.2		
ERP (dBm)	57.1	57.0	57.0		
RUN TEST		PREV TEST		NEXT TEST	
				RETURN	

XPDR - POWER/FREQ				PASS	BAT 2.5 Hr
TX FREQ = 1090.12 MHz					
MEASURED VIA	TOP DIRECT	BOTTOM ANTENNA	INSTANT DIRECT		
MTL (dBm)					
ATCRBS	N/A	-73.1	-73.2		
A-C DIFF	N/A	0.1	0.0		
ALL CALL	N/A	-73.2	-73.2		
ERP (dBm)	N/A	57.0	57.0		
RUN TEST		PREV TEST		NEXT TEST	
				RETURN	

XPDR Power and Frequency Test

The XPDR Power and Frequency Test performs these functions:

- ◆ Measures, verifies, and displays TX Frequency in MHz
- ◆ Measures, verifies, and displays TX ERP for top and bottom antennas in dBm, dBW or W.

◆ Measures, verifies, and displays MTL for top and bottom antennas, for ATRBS, ATRBS All-Call and Mode S (P6) interrogation types in dBm.

Top or Bottom antenna measurement is selected with DATA Keys. Top and Bottom measurements are averaged, and values are displayed.

NOTE: When an ATRBS configuration is selected (non-diversity transponder) only the Bottom antenna measurement fields are used.

Frequency

When a Mode S configuration is selected, the Test Set interrogates with UF4, +6 dB above MTL, verifying a DF4 reply is received.

With an ATRBS configuration selected, the Test Set interrogates with Mode A, (or Mode C if no reply is received to a Mode A), +6 dB above MTL.

Test averages Frequency measurement over 40 replies. The value is updated every 40 replies. PASS/FAIL limits are applied.

NOTE: Frequency PASS/FAIL limits are determined by selected configuration. Refer to Appendix F.

ERP (Effective Radiated Power)

When a Mode S configuration is selected, the Test Set interrogates with UF4, +6 dB above MTL, verifying a DF4 reply is received.

When an ATRBS configuration is selected, the Test Set interrogates with Mode A (or Mode C if no reply is received to a Mode A) +6 dB above MTL.

When the (peak) ERP is measured, two values for each measurement are displayed. INSTANT values are obtained from the average power measurement over five replies and updated every five replies.

TOP and BOTTOM values are obtained from the average power measurement over 40 replies. PASS/FAIL limits are applied and updated every 40 replies.

NOTE: ERP PASS/FAIL limits are determined by selected configuration. Refer to Appendix F.

NOTE: ERP and MTL Upper limits specified in selected configuration file are not applied during radiated test. The configuration file upper limits are in accordance with RTCA-DO181C, which are based on maximum feeder cable loss of 3 dB and measurement at the antenna port. ERP and MTL Upper limits are only applied when directly connected to UUT or end of feeder cable. In practice, many installations have feeder losses of 1 dB (minimum feeder loss) and antennas that exhibit gain.

MTL (Minimum Trigger Level)

When a Mode S configuration is selected the Test Set interrogates in sequence with UF4, Mode A (or Mode C if no reply is received to a Mode A) and an ATRBS/Mode S All-Call, verifying MTL for each interrogation type.

When an ATRBS configuration is selected the Test Set interrogates with Mode A (or Mode C if no reply is received to a Mode A) and an ATRBS/Mode S All-Call, verifying MTL for each interrogation type.

To determine MTL the test adjusts RF interrogation level for 90% replies. Two values for each measurement are displayed. INSTANT values are obtained from the MTL readings. The 50% reply point is determined by sending 100 interrogations. The 90% reply point is calculated from the 50% reply point.

TOP and BOTTOM values are obtained from the average MTL readings of all replies received during the MTL Test sequence. PASS/FAIL limits are applied.

NOTE: MTL PASS/FAIL limits are determined by the selected configuration. Refer to Appendix F.

A-C Difference

The Test Set interrogates with Mode A (or Mode C if no reply is received to a Mode A), verifying MTL for each interrogation type.

The test compares MTL measurements between Mode A and C. PASS is displayed when difference is <1 dB. FAIL is displayed when difference is >1 dB.

XPDR-S ALL-CALL		PASS		BAT 2.5 Hr	
ITM REPLY					
DELAY	A=128.08 us	C=128.07 us			
JITTER	A=0.510 us	C=0.510 us			
ADDRESS	A=2AC421	C=2AC421			
RATIO	A=100%	C=100%			
-81dBm	A=0%	C=0%			
MODE S ALL-CALL = PASS					
ADDRESS = 2AC421					
TAIL= N12345					
COUNTRY= United States					
RUN TEST		PREV TEST		NEXT TEST	
				RETURN	

XPDR - S All Call Test

The XPDR - S All Call Test performs these functions:

- Verifies and displays ITM Reply Delay Mode A and C
- ♣ Verifies and displays ITM Reply Jitter Mode A and C
- ♣ Verifies ITM Reply Ratio Mode A and C
- ♦ Verifies ITM All Call Address
- ♦ Verifies Mode S All Call.
- ♦ Verifies and displays Mode S All Call Address
- Verifies Country and Tail Number

ITM Reply Delay

The Test Set interrogates UUT with an ATCRBS/Mode S All-Call, +6 dB above MTL, verifying DF11 replies are received. The test verifies reply delay minus range delay is:

- 128.00 \pm 0.50 μ s for ITM Mode A and C.

Measurements outside this tolerance result in a FAIL and are identified by an arrow.

NOTE: Range delay is 2.03 ns/ft (6.67 ns/m), calculated from the range values in the Setup Menu.

ITM Reply Jitter

The Test Set interrogates UUT with a Mode S All-Call, +6 dB above MTL, verifying DF11 replies are received.

The test verifies reply jitter values (difference between shortest and longest reply delay). Reply jitter (changes in reply delay) is:

- 0.08 μ s for ITM Mode A and C

Measurements outside this tolerance result in a FAIL and are identified by an arrow.

ITM Reply Ratio

The Test Set interrogates UUT with a Mode S All-Call, +6 dB above MTL, verifying DF11 replies are received. The test verifies that ITM Mode A and C replies are \pm 90% between MTL +6 dB and \pm 10% for -81 dBm. Replies outside these tolerances result in a FAIL and are identified by an arrow.

NOTE: Above paragraph only applicable to direct connect testing.

NOTE: Transponder occupancy in 'over the air testing' prevents reliable Reply Ratio measurements. When Antenna is selected, Reply Ratio ITM Mode A and C Test displays percent replies however, PASS/FAIL test limits are not applied.

ITM Address

The Test Set interrogates UUT with a Mode S All-Call, +6 dB above MTL, verifying DF11 replies are received.

The test decodes and displays the discrete address reported in the DF11 replies.

Mode S All-Call

The Test Set interrogates UUT with a Mode S All-Call UF11, AA=FFFFFF, +6 dB above MTL, verifying DF11 replies are received.

The test interrogates with a UF4 using the discrete address obtained in the DF11 reply and confirms the DF4 reply contains the same address and displays a PASS. If an incorrect address is received the address and FAIL are displayed. A FAIL is identified by an arrow.

Address, Tail and Country

The Test Set interrogates UUT with a Mode S All-Call UF11, AA=FFFFFF, +6 dB above MTL, verifying DF11 replies are received.

The test decodes and displays discrete address reported in the DF11 replies, country and tail number.

NOTE: Some countries have encoded the aircraft tail number into the Mode S discrete address. Refer to Appendix G for list of countries supported. If not supported only the country is displayed.

```
XPDR-S RPLY TIMING      FAIL  BAT 2.5 Hr

▶ REPLY DELAY =148.05 us
▶ REPLY JITTER=0.950 us
  PULSE WIDTH=PASS
▶ PULSE SPACING =FAIL

[RUN TEST]  [PREV TEST]  [NEXT TEST]  [RETURN]
```

XPDR - S Reply Timing Test:

XPDR - S Reply Timing Test performs these functions:

- ◆ Verifies Mode S Reply Delay
- ♣ Verifies Mode S Reply Jitter
- ♣ Verifies Mode S Reply Pulse Width (all pulses)
- ♣ Verifies Mode S Reply Pulse Spacing (all pulses)

Reply Delay

The Test Set interrogates UUT with UF4, 6 dB above MTL, verifying reply is received with the same address and correct format. The test verifies if reply delay minus range delay is:

- 128.00 μ s ($\pm 0.25 \mu$ s) for Mode S
- Measurements outside this tolerance result in a FAIL and are identified by an arrow.

NOTE: Range delay is 2.03 ns/ft (6.67 ns/m), calculated from the values in the Setup Menu.

Reply Jitter

The Test Set interrogates UUT with UF4, 6 dB above MTL, verifying reply is received with the same address and correct format.

The test verifies reply jitter values (difference between shortest and longest reply delay). Reply jitter (changes in reply delay) is:

μ 0.08 μ s

Measurements outside this tolerance result in a FAIL and are identified by an arrow.

Pulse Width

The Test Set interrogates UUT with UF4, +6 dB above MTL, verifying reply is received with the same address and correct format. Test verifies that the widths are:

0.5 μ s ($\pm 0.05 \mu$ s) or 1.0 μ s ($\pm 0.05 \mu$ s)

Pulse Spacing

The Test Set interrogates UUT with UF4, 6 dB above MTL. Verifying reply is received with the same address and correct format. The test verifies that the pulse spacing are within $\pm 0.05 \mu$ s of nominal values.

NOTE: Pulse width spacing measured on preamble only (first release).

```
XPDR-S REPLY          PASS  BAT 2.5 Hr

PULSE AMP VAR  SHRT=0.1 dB  LNG=0.1 dB
SLS           ON=NO REPLY  OFF=REPLY
SQTR          DF11 PERIOD=1.00s
              DF17 DETECTED=YES

REPLY RATIO =100%
REPLY RATIO 81dBm =0%
INVALID AA =PASS
DIVERSITY ISOLATION=GREATER THAN 25dB

[RUN TEST]  [PREV TEST]  [NEXT TEST]  [RETURN]
```

XPDR - S REPLY Test:

The XPDR - S Reply Test performs these functions:

- ♣ Verifies Mode S Pulse Amplitude Variation Short Reply
- ♣ Verifies Mode S Pulse Amplitude Variation Long Reply
- ♣ Verifies Mode S SLS Level
- ♣ Verifies Mode S Reply Ratio
- ◆ Verifies and displays Mode S DF11 Squitter Period
- ♣ Verifies Mode S DF11 Squitter Distribution.
- ◆ Verifies Mode S Invalid AA
- Verifies S DF17 Detect
- ◆ Verifies and displays Mode S Diversity Isolation

Pulse Amplitude Variation Short

The Test Set interrogates with UF4 (reply length short) interrogations, +6 dB above MTL. The test verifies all pulses in the DF4 replies are within a 2 dB amplitude window. Replies outside the 2 dB window result in a FAIL indication and are identified by an arrow. The measured variation is displayed.

Pulse Amplitude Variation Long

The Test Set interrogates with UF4 (reply length long) interrogations, +6 dB above MTL. The test verifies all pulses in the DF20 replies are within a 2 dB amplitude window. Replies outside the 2 dB window result in a FAIL indication and are identified by an arrow. The measured variation is displayed.

SLS Level

The Test Set interrogates with UF4 interrogations including the P5 SLS pulse. For Direct Connect, when P5 level is set at -12 dB and replies are $\geq 99\%$, the test indicates PASS.

For Antenna Connect, when P5 level is set at -12 dB and replies are $\geq 90\%$, the test indicates a PASS. When P5 level is set at +3 dB and replies are $\geq 10\%$, the test indicates PASS.

NOTE: Because interrogation with SLS at -12 dB is sent at MTL + 12 dB, SLS Test must be run within 95 feet (28.96 meters) of UUT antenna being tested.

Reply Ratio

The Test Set interrogates UUT with UF4. The test verifies that replies are $\geq 99\%$ for MTL +6 dB and $\geq 10\%$ for -81 dBm. Replies outside this tolerance result in a FAIL and are identified by an arrow.

NOTE: Above paragraph only applicable to direct connect testing.

NOTE: Transponder occupancy in 'over the air testing' prevents reliable Reply Ratio measurements. When Antenna is selected, Reply Ratio Mode S Test displays percent replies however, PASS/FAIL test limits are not applied.

Squitter Period

The Test Set monitors the UUT DF11 acquisition squitters and verifies that the period is 0.6 to 2.4 s. A Squitter period outside this tolerance results in a fail and is identified by an arrow.

DF17 Detected

The Test Set monitors the UUT DF17 extended squitters and confirms detection by displaying YES. Test displays NO if DF17's are not detected.

Invalid AA

The Test Set interrogates with UF4 interrogations, +6 dB above MTL. Test uses default addresses that are 1 and 256 greater than the correct address. Test displays PASS if no replies are received and FAIL if replies are received.

Diversity Isolation

The Test Set monitors the UUT DF11 acquisition squitters. The test verifies UUT diversity isolation (difference between "On" antenna squitters and "Off" antenna squitters) is ≥ 20 dB. Values < 20 dB result in a FAIL and are identified with an arrow.

Indications:

- OFF is displayed if diversity isolation is not selected in Setup Screen.
- > 25 dB.
- Value in dB.

NOTE: For > 20 dB dynamic range, test must be run within 50 ft (15.24 m) of UUT antenna being tested.

NOTE: When Diversity Isolation Test is enabled, make sure Antenna Shield is fitted to top or bottom UUT antenna prior to running test. It is important that only one UUT antenna is seen during the Diversity Test. Make sure Test Set Directional Antenna is pointed at unshielded antenna. Refer to Appendix J for Antenna Shield mounting procedure.

NOTE: This test must be enabled on the XPDR Setup Screen to display diversity isolation parameter.

XPDR - UFO	PASS	BAT 2.5 Hr
DF = 0		
VS = 0 - IN AIR		
CC = 0 - NOT SUPPORTED		
SL = 0 - NO TCAS SENS LEVEL REPORTED		
RI = 12 - AIRSPEED 301 TO 600 KNOTS		
AC = 03A0(01640) 10700 FT		
MODE C ALT COMPARE = PASS		
AA = AC3421(53032041)		
DF11 ADDRESS COMPARE = PASS		
RUN TEST	PREV TEST	NEXT TEST
		RETURN

UF0 Test

The UF0 (Short Air to Air Surveillance) Test performs these functions:

- ◆ Verifies replies to Mode S UF0 interrogations and compares discrete address with DF11.
- ◆ Decodes and displays DF0 data fields.
- ◆ Compares Mode S altitude to Mode C altitude.

The Test Set interrogates with UF0, +6 dB above MTL, verifying a UF0 reply is received. Altitude reported in DF0 is compared with altitude reported during Mode Test in valid ATCRBS Mode C reply. Altitudes must agree within 100 ft.

Address is compared with address reported during Mode Test in DF11 reply. DISPLAY indicates the Downlink Format Fields. If test fails due to incorrect altitude, Mode C altitude is displayed. If test fails due to wrong address, DF11 address is displayed. UF0 AQ bit is "1" for requesting airspeed information in DF0 RI field.

NOTE: AC field blanks out if invalid data is received for that field.

Testing VS (Vertical Status)

ICAO amendment 77 transponders only replies to Mode S discrete interrogations when installation is in ground state. Refer to para 1-2-4.4.2 for UUT ADDRESS and MANUAL AA settings.

XPDR - UF4	PASS	BAT 2.5 Hr
DF = 4	FS = 3 - ALERT	NO SPI ON GROUND
DR = 0 - NO DOWNLINK REQUEST	UM = 0 - (IDS = 0)	(IIS = 0)
AC = 03A0(01640)	10700 FT	MODE C ALT COMPARE = PASS
AA = AC3421(53032041)	DF11 ADDRESS COMPARE = PASS	
RUN TEST	PREV TEST	NEXT TEST
		RETURN

UF4 Test

UF4 (Short Surveillance Altitude) Test performs these functions:

- ◆ Verifies replies to Mode S UF4 interrogations and compares discrete address with DF11.
- ◆ Decodes and displays DF4 data fields.
- ◆ Compares Mode S altitude to Mode C altitude.

The Test Set interrogates with UF4, +6 dB above MTL, verifying a DF4 reply is received.

Altitude reported in DF4 is compared with altitude reported during Mode Test in valid ATCRBS Mode C reply. Altitudes must agree within 100 ft.

Address is compared with address reported during Mode Test.

NOTE: AC field blanks out if invalid data is received for that field.

Testing FS (Flight Status)

ICAO amendment 77 transponders only reply to Mode S discrete interrogations when installation is in ground state. Refer to para 1-2-4.4.2 for UUT ADDRESS and MANUAL AA settings.

XPDR-UF5	PASS	BAT 2.5 Hr
DF=5	FS=0-NO ALERT	NO SPI IN AIR
DR=0-NO DOWNLINK REQUEST	UM=0 - (IDS = 0)	(IIS = 0)
ID=020A(01012)	OCTAL ID 2600	MODE A ID COMPARE=PASS
AA=AC3421(53032041)	DF11 ADDRESS COMPARE=PASS	
RUN TEST	PREV TEST	NEXT TEST
		RETURN

UF5 Test

The UF5 Test (Short Surveillance Identity) performs these functions:

- ◆ Verifies replies to Mode S UF5 interrogations and compares discrete address with DF11.
- ◆ Decodes and displays DF5 data fields.
- ◆ Compares Mode S Identity Code to Mode A Squawk Code.

The Test Set interrogates with UF5, +6 dB above MTL, verifying a DF5 reply is received.

ID code reported in DF5 is compared with ID code reported during Mode Test in valid ATCRBS Mode A reply. Address is compared with address reported during Mode Test.

Testing FS (Flight Status)

ICAO amendment 77 transponders only reply to Mode S discrete interrogations when installation is in ground state. Refer to para 1-2-4.4.2 for UUT ADDRESS and MANUAL AA settings.

XPDR-UF11		PASS		BAT 2.5 Hr	
DF=11					
CA=0-LEVEL 2 CA MODE					
PI =02F08D					
AA=AC3421(53032041)					
II LOCKOUT TIMER=18S					
II MATCH=PASS					
SI LOCKOUT TIMER=18S					
SI MATCH=PASS					
RUN TEST		PREV TEST		NEXT TEST	
				RETURN	

UF11 Test

UF11 Test performs these functions:

- ◆ Interrogates with Mode S UF11, AP set FFFFFFFF. Decodes and displays DF11 replies.
- ♣ Performs comprehensive II and SI Match Test.
- Performs II and SI lockout Timer Test.

The Test Set interrogates with UF11, +6 dB above MTL, verifying a DF11 reply is received.

Address is compared with address reported during Mode Test in DF11 reply. Test interrogates with a UF11, using the 15 II codes, in sequence from 1 to 15. If all codes are correct PASS is displayed. If the transponder supports SI (Surveillance Identifier) each of the 63 SI codes from 1 to 63 are tested. When all codes are correct PASS is displayed. BDS 1,0 is verified to determine SI support.

NOTE: When a single code fails the code is displayed. When more than one code fails, the range of codes are displayed. An arrow identifies a FAIL.

The multi-site lockout protocol is utilized in conjunction with an II code to verify lockout (not accept any Mode S only All-Call) time. If lockout time is 18 sec (± 1 sec), PASS is displayed. FAIL is displayed if lockout time is outside this window.

The multi-site lockout protocol is utilized in conjunction with an SI code to verify lockout (not accept any Mode S only All-Call) time. If lockout time is 18 sec (± 1 sec), PASS is displayed. FAIL is displayed if lockout time is outside this window.

The test interrogates during the lockout period with a different SI code to confirm interrogation acceptance.

NOTE: Due to long test time required, lockout timer test is not run as part of Auto Test. Test is run only if UF11 Test is performed separately.

XPDR - UF11		FAIL		BAT 2.5 Hr	
DF = 11					
CA = 0 - LEVEL 2 CA MODE					
PI = 02F08D					
AA = AC3421(53032041)					
II LOCKOUT TIMER=18S					
▶ II MATCH = 0-1,3-4,6-7,9-10,12-13,15					
SI LOCKOUT TIMER = 18S					
▶ SI MATCH = 1-2,4-5,7-8,10-11,13-14,					
16-17,19-20,22-23,25-26,					
28-29,31-32,34-35,37-38,					
40-41,43-44,46-47,49-50,					
52-53,55-56,58-59,61-62					
RUN TEST		MORE INFO		PREV TEST	
				NEXT TEST	
				RETURN	

XPDR-UF16	PASS	BAT 2.5 Hr
DF=16 VS=0 - IN AIR SL=0 RI=0-NO ON - BOARD TCAS MV=30010000000000		
AC=03A0(01640) 10700 ft MODE C ALT COMPARE=PASS AA=AC3421(53032041) DF11 ADDRESS COMPARE=PASS		
RUN TEST	PREV TEST	NEXT TEST
		RETURN

UF16 Test

UF16 Test (Long Air to Air Surveillance) performs these functions:

- ◆ Verifies replies to Mode S UF16 interrogations and compares discrete address with DF11.
- ◆ Decodes and displays DF16 data fields.
- ◆ Compares Mode S Altitude to Mode C Altitude.

The Test Set interrogates with UF16, +6 dB above MTL, verifying a DF16 reply is received.

Altitude reported in DF16 is compared with altitude reported during Mode Test in valid ATCRBS Mode C reply. Altitudes must agree within 100 ft.

Address is compared with address reported during Mode Test in DF11 reply. The DISPLAY indicates the Downlink Format Fields. If test fails because of incorrect altitude, Mode C altitude is displayed. If test fails due to wrong address, DF11 address is displayed.

NOTE: AC field blanks out if invalid data is received for that field.

NOTE: No reply to UF16 results in Mode S pass in Auto Test.

NOTE: Replies to UF16 are received only if an active TCAS II system is installed.

Testing VS (Vertical Status)

ICAO amendment 77 transponders only replies to Mode S discrete interrogations when installation is in ground state. Refer to para 1-2-4.4.2 for UUT ADDRESS and MANUAL AA settings.

XPDR-UF20	PASS	BAT 2.5 Hr
DF=20 FS=3-ALERT NO SPI ON GROUND DR=0-NO DOWNLINK REQUEST UM=0 (IDS=0) (IIS = 0) MB=30010000000000		
AC=03A0(01640) 10700 ft MODE C ALT COMPARE=PASS AA=AC3421(53032041) DF11 ADDRESS COMPARE=PASS		
RUN TEST	PREV TEST	NEXT TEST
		RETURN

UF20 Test

UF20 (Long Surveillance Altitude) Test performs these functions:

- ◆ Verifies replies to Mode S UF20 interrogations and compares discrete address with DF11.
- ◆ Decodes and displays DF20 data fields. Displays MB message field in HEX.
- ◆ Compares Mode S altitude to Mode C altitude.

The Test Set interrogates with UF20 (Comm A, altitude request), RR=17 (long reply), DI=7, RRS=0, requesting a BDS 1,0 data link capability report, +6 dB above MTL, verifying a DF20 reply is received. If reply is not received, the test interrogates for BDS 3,0 TCAS sensitivity status message.

Altitude reported in DF20 is compared with altitude reported during Mode Test in valid ATCRBS Mode C reply. Altitudes must agree within 100 ft.

Address is compared with address reported during Mode Test in DF11 reply.

NOTE: The BDS 3,0 TCAS sensitivity status message interrogates with Mode S UF20 (Comm A, altitude request), RR=19 (long reply), DI=7, RRS=0, MA=05000000000000, verifying DF20 reply received has correct altitude (compared with Mode C altitude), address (compared with Mode Test address) and format.

NOTE: Data displayed in MB message field is not decoded.

NOTE: The Datalink Capability Report determines the level of transponder under test.

NOTE: AC field blanks out if invalid data is received for that field.

NOTE: Transponders without active subsystems capable of accepting Comm A data do not reply to UF20 interrogations.

Testing FS (Flight Status)

ICAO amendment 77 transponders only reply to Mode S discrete interrogations when installation is in ground state. Refer to para 1-2-4.4.2 for UUT ADDRESS and MANUAL AA settings.

XPDR-UF21	PASS	BAT 2.5 Hr
DF=21 FS=3-ALERT NO SPI ON GROUND DR=0-NO DOWNLINK REQUEST UM=0 (IDS=0) (IIS = 0) MB=30010000000000		
ID=03A0(01640) OCTAL ID 6140 MODE A ID COMPARE=PASS AA=AC3421(53032041) DF11 ADDRESS COMPARE=PASS		
RUN TEST	PREV TEST	NEXT TEST
		RETURN

UF21 Test

UF21 (Long Surveillance Identity) Test performs these functions:

- ◆ Verifies replies to Mode S UF21 interrogations and compares discrete address with DF11.

- ◆ Decodes and displays DF21 data fields. Displays MB message field in HEX.

- ◆ Compares Mode S Identity Code to Mode A Squawk Code.

The Test Set interrogates with UF21 (Comm A, altitude request), RR=17 (long reply), DI=7, RRS=0, requesting a BDS 1,0 data link capability report, +6 dB above MTL, verifying a DF21 reply is received. If reply is not received test interrogates for BDS 3,0 TCAS sensitivity status message.

ID code reported in DF21 is compared with ID code reported during Mode Test in valid ATCRBS Mode A reply.

Address is compared with address reported during Mode Test in DF11 reply.

NOTE: The BDS 3,0 TCAS sensitivity status message interrogates with Mode S UF20 (Comm A, altitude request), RR=19 (long reply), DI=7, RRS=0, MA=05000000000000, verifying DF20 reply received has correct altitude (compared with Mode C altitude), address (compared with Mode Test address) and format.

NOTE: Data displayed in MB message field is not decoded.

NOTE: BDS 1,0 Datalink Capability Report determines the level of transponder under test.

XPDR-UF21	BAT 2.5 Hr
DF=	
FS=	
DR=	
UM=	(IDS=) (IIS=)
MB=	
ID= ()	OCTAL ID
MODE A ID COMPARE=	
AA= ()	
DF11 ADDRESS COMPARE=	
RUN TEST	PREV TEST
	NEXT TEST
	RETURN

NOTE: Transponders without active subsystems capable of accepting Comm A data does not reply to UF21 interrogations.

Testing FS (Flight Status)

ICAO amendment 77 transponders only reply to Mode S discrete interrogations when installation is in ground state. Refer to para 1-2-4.4.2 for UUT ADDRESS and MANUAL AA settings.

XPDR-UF24		PASS		BAT 2.5 Hr	
RESERVATION UF 4					
DF=20	IIS=15	IDS=2	AA=AC3421		
SEGMENTS UF24					
DF=24	KE=1	ND=0	TAS=FFFF AA=AC3421		
CLOSEOUT UF 4					
DF=20	IIS=15	IDS=2	AA=AC3421		
RUN TEST	PREV TEST	NEXT TEST	RETURN		

UF24 Test

The UF24 Test completes the 16-segment data transfer (UELME protocol) verifying UF24.

Interrogates with Mode S UF4 UELM reservation, verifying reply received is a DF20 UELM Reservation (Comm-B). Interrogates with Mode S UF24 (Comm-C) UELM segments, one initial, 14 intermediate and one final interrogation. Verifies reply received is a Mode S DF24 (Comm-D) acknowledgment.

When the close-out is completed, the IIS displayed equals the IIS displayed in the reservation.

Interrogates with Mode S UF4, +6 dB above MTL, UELM close-out and verifies reply received is a DF20 UELM close-out (Comm-B).

TAS Field displays the number of transferred segments. TAS data consists of 16 bits, each bit representing a segment, displayed as four hex digits.

No reply to the UELM Test sequence does not fail Mode S in Auto Test.

NOTE: BDS 1,0 Datalink Capability Report determines the level of transponder under test. If level <3 is reported, test is not run and NOT CAPABLE is displayed.

XPDR - ELEMENT SURV1		PASS		BAT 2.5 Hr	
BDS=1,0	SUBNETWORK VER =1				
	ENH PROT IND =LVL 2-4				
	SPEC SERV CAP =YES				
	UELME CAPABILITY =16/1 s				
	DELM CAPABILITY =16/500 ms				
	AIRCRAFT ID CAP =YES				
	SURV IDENT CAP =YES				
	COMM USE GICB REP=1				
	DTE =YES				
	CONT FLAG =YES				
	SQUITTER CAP =YES				
RUN TEST	PREV TEST	NEXT TEST	RETURN		

XPDR Elementary Surveillance 1 Test

XPDR Elementary Surveillance Test performs these functions:

- Verifies, decodes and displays BDS 1,0 Data Link Capability Report.

NOTE: Only the primary data fields are displayed. For full decode and display of GICB extracted BDS registers, the ADS-B option is required.

Data Link Capability Report BDS 1,0

The Test Set Interrogates with UF4 RR=17 DI=7 RRS=0, decodes DF20 reply and displays data link capability report comprising the following fields:

SUBNETWORK VER:

(Mode S Subnetwork Version Number)
0 to 127

ENH PROT IND:

(Enhanced Protocol Indicator)
2-4 (Transponder Level 2-4) or 5
(Transponder Level 5 Enhanced Protocol)

SPEC SER CAP:

(Mode S Specific Services Capability Report):
YES or NO

UELME SEG CAP:

(Uplink Extended Length Message Segment Capability)

NO UELME, 16/1 S, 16/500 mS,
16/250 mS, 16/125 mS, 16/60 mS or
16/30 mS

(Ex: 16 segments transferred in 500 ms.)

DELM SEG CAP:
 (Downlink Extended Length Message Segment Capability)
NO DELM, 4/1 S, 8/1 S, 16/1 S, 16/500 mS, 16/250 mS, 16/125 mS or 7 to 15 (unassigned)
 (Ex: Eight segments transferred in 1 sec.)

AIRCRAFT ID CAP:
 (Aircraft Identification Capability)
 YES or NO

SURV IDENT CAP:
 (Surveillance Identifier Code Capability)
 YES or NO

COMM/USE GICB CAP REP:
 (Common Usage [Ground Initiated Comm B] Capability Report)
 1 or 0
 This bit changes when the common usage GICB capability report BDS 1,7 content changes.

DTE:
 (Data Terminal Equipment)
 YES or NO

CONT FLAG:
 (Continuation Flag).
 YES (Yes means that a continuation report may be found in registers BDS 1,1 up to BDS 1,6 which are not implemented in this revision)
 NO

SQUITTER CAP:
 (Capability Subfield)
 YES (Surveillance code identifier capability),
 NO (No surveillance code identifier capability)

NOTE: If CHECK CAP is enabled in Setup Menu, capability of test is determined from BDS 1,0

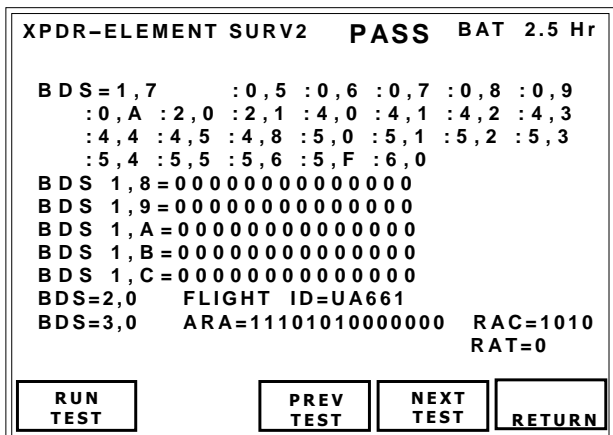

XPDR Elementary Surveillance 2 Test

XPDR Elementary Surveillance Test performs these functions:

- ♣ Verifies, decodes, and displays BDS 1,7 Common Usage GICB Capability Report.
- ♣ Verifies, decodes and displays BDS 1,8 to BDS 1,C Specific Services Capability Report.
- ♣ Verifies, decodes, and displays BDS 2,0 Aircraft Identification (Flight ID).
- ♣ Verifies, decodes, and displays BDS 3,0 ACAS Resolution Advisory.

NOTE: Only primary data fields are displayed. For full decode and display of GICB extracted BDS registers, the ADS-B option is required.

GICB Common Usage Capabilities Report: Interrogates with UF4 RR=16 DI=7 RRS=7, decodes DF20 reply and displays common usage GICB capability report.

The Screen displays BDS Numbers for the common usage GICB services currently supported by the transponder and decodable by the Test Set.

BDS	DESCRIPTION
0,5	Ext Squitter Airborne Position
0,6	Ext Squitter Surface Position
0,7	Ext Squitter Status
0,8	Ext Squitter Type and Identification
0,9	Ext Squitter Airborne Velocity Information
0,A	Ext Squitter Event Driven Information
1,0	Data Link Capability Report
1,7	Common Usage GICB Capability Report
2,0	Aircraft Identification (Flight ID)
2,1	Aircraft Registration Number
3,0	ACAS Resolution Advisory
4,0	Aircraft Vertical Intention
4,1	Next Way Point Identifier
4,2	Next Way Point Position
4,3	Next Way Point Information
4,4	Meteorological Routine Report
4,5	Meteorological Hazard Report
4,8	VHF Channel Report
5,0	Track and Turn Report
5,1	Position Coarse
5,2	Position Fine
5,3	Air Referenced State Vector
5,4	Way Point 1
5,5	Way Point 2
5,6	Way Point 3
5,F	Quasi-Static Parameter Monitoring
6,0	Heading and Speed Report

Common Usage GICB BDS
Table 2

NOTE: Refer to 1-2-4, Table 2. Dark Shaded BDS are not supported by current IFR 6000 software. Light shaded BDS are supported by ADS-B option.

Specific Services GICB Capability Report BDS 1,8

BDS 1,8 Interrogates with UF4 RR=17 DI=7 and RRS=8. DF20 reply BDS register content displayed as 14 HEX digits. Each bit set indicates capability supported for BDS 0,1 to 3,8.

Specific Services GICB Capability Report BDS 1,9

BDS 1,9 Interrogates with UF4 RR=17 DI=7 and RRS=9. DF20 reply BDS register content displayed as 14 HEX digits. Each bit set indicates capability supported for BDS 3,9 to 7,0.

Specific Services GICB Capability Report BDS 1,A

BDS 1,A Interrogates with UF4 RR=17 DI=7 and RRS=10. DF20 reply BDS register content displayed as 14 HEX digits. Each bit set indicates capability supported for BDS 7,1 to A,8.

Specific Services GICB Capability Report BDS 1,B

BDS 1,B Interrogates with UF4 RR=17 DI=7 and RRS=11. DF20 reply BDS register content displayed as 14 HEX digits. Each bit set indicates capability supported for BDS A,9 to E,0.

Specific Services GICB Capability Report BDS 1,C

BDS 1,C Interrogates with UF4 RR=17 DI=7 and RRS=12. DF20 reply BDS register content displayed as 14 HEX digits. Each bit set indicates capability supported for BDS E,1 to F,F.

Aircraft Identification (Flight ID) BDS 2,0

The Test Set Interrogates with Mode S UF4 (Comm A Identity request), RR=18 (long reply) to request DF20 with AIS reply. Verifies reply received is a DF20 (Comm-B) with an AIS field containing valid characters.

NOTE: If Flight ID is not entered into transponder or linked subsystem, AIS is zero (0).

ACAS Resolution Advisory BDS 3,0

Test Set Interrogates with UF4, +6 dB above MTL, RR=19 DI=7 RRS=0, decodes DF20 reply and displays active resolution advisory data, including RAT (Resolution Advisory Terminated) bit.

NOTE: TCAS II must be installed, and a resolution advisory must be in progress for data to be displayed on this Screen. RA may be stimulated by Test Set or a TCAS-201 Test Set running a collision scenario

XPDR-ENHANCED SURV		PASS	BAT 2.5 Hr
BDS4,0	MCP/FCU SEL ALT	=65520 ft	
	BARO PRES SET	=	
BDS5,0	ROLL ANGLE	= 40.1 deg	
	TRUE TRACK ANGLE	= 90.3 deg	
	GROUND SPEED	= 512 kts	
	TRACK ANGLE RATE	= 4.00 deg/s	
	TRUE AIR SPEED	= 512 kts	
BDS6,0	MAGNETIC HEADING	= 164.2 deg	
	IND AIR SPEED	= 512 kts	
	MACH NO	= 0.300	
	INERT VERT VEL	=-1400 ft/min	
	BARO ALT RATE	=-1400 ft/min	
RUN TEST		PREV TEST	NEXT TEST
		RETURN	

XPDR Enhanced Surveillance Test

XPDR Enhanced Surveillance Test performs these functions:

- ♣ Verifies, decodes, and displays BDS 4,0 Aircraft Vertical Intention.
- ♣ Verifies, decodes, and displays BDS 5,0 Track and Turn Report.
- ♣ Verifies, decodes, and displays BDS 6,0 Heading and Speed Report.

NOTE: Only primary data fields are displayed. For full decode and display of GICB extracted BDS registers, the ADS-B option is required.

NOTE: BDS Data Items not available are identified by displaying N/A in the data field.

NOTE: If Check Cap is enabled, BDS 1,7 is verified to confirm availability of:

- BDS 4,0
- BDS 5,0
- BDS 6,0

Aircraft Vertical Intention BDS 4,0

The Test Set Interrogates with UF4 RR=20 DI=7 RRS=0, decodes DF20 reply and displays vertical intent report data.

NOTE: ADLP (Air Data Link Processor) must be installed, or transponder must have embedded ADLP to receive data from subsystem (in this case the FMS [Flight Management System]).

MCP/FCU SEL ALT:

(Mode Control Panel/Flight Control Unit Selected Altitude) displayed in feet.

Track and Turn Report BDS 5,0

The Test Set Interrogates with UF4 RR=21 DI=7 RRS=0, decodes DF20 reply and displays Track and Turn Report data.

NOTE: ADLP (Air Data Link Processor) must be installed, or transponder must have embedded ADLP to receive data from subsystem (in this case the FMS [Flight Management System]).

ROLL ANGLE:

±90.0 deg

TRUE TRACK ANGLE:

(True Track Angle)
-180 to 180 deg

GROUND SPEED:

(Ground Speed)
0 to 2048 kts (2 kt resolution)

TRUE TRACK ANGLE RATE:

(True Track Angle Rate)
±16.0 deg/sec

TRUE AIR SPEED:

(True Air Speed)
0 to 2046 kts (2 kt resolution)

Heading and Speed Report BDS 6, 0

The Test Set Interrogates with UF4 RR=22
DI=7 RRS=0, decodes DF20 reply and
displays Heading and Speed Report data.

MAG HDG:

(Magnetic Heading)
-180 to 180 deg

IND AIR SPEED:

(Indicated Air Speed)
0 to 1023 kts (1 kt resolution)

MACH NO:

(Mach Number)
0 to 4.096 (Mach Number)

INERT VERT VEL:

(Inertial Vertical Velocity)
-16384 to +16352 ft/min
(32 ft/min resolution)

BARO ALT RATE:

(Barometric Altitude Rate)
-16384 to +16352 ft/ min (32 ft/min
resolution)

4.4.5 Altitude ENCODER

XPDR-ALT ENCODER	BAT 2.5 Hr
SOURCE: ENCODER	
ALTITUDE = 100000 ft	
A4 A2 A1 B4 B2 B1 C4 C2 C1 D4 D2	
RUN TEST	SELECT SOURCE

Altitude Encoder

Altitude Encoder performs these functions:

Decodes and displays altitude in feet and binary code (grey code) from encoding altimeters.

Altitude

Encoding altimeter is connected via user manufactured cable to Remote Connector. Altitude is decoded and displayed in feet and binary lines are monitored and displayed as A4, A2, A1, B4, B2, B1 C4, C2, C1, D4, D2. A logic 0 is displayed by a strike through (A4).

STEP	PROCEDURE
------	-----------

1. Press XPDR Mode Key until the XPDR ENCODER Screen is displayed.
2. Use DATA Keys or SELECT SOURCE Soft Key to select ENCODER.
3. Connect Test Set. Remote Connector, Altitude Encoder inputs to UUT Encoding Altimeter via user provided cable. Refer to Appendix A for remote connector pinouts.
4. Press RUN TEST Soft Key.
5. Use Barometric Test Set to pump up UUT Encoding Altimeter to desired test altitudes and confirm altitude on display.

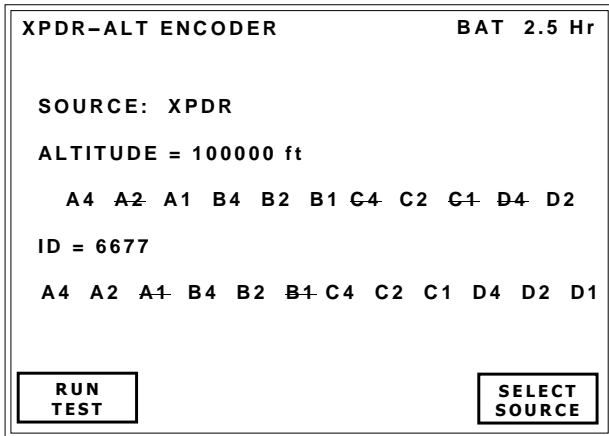

4.4.6 XPDR SETUP DIRECT CONNECT

STEP	PROCEDURE
1.	Connect long RF coaxial cable between the aircraft antenna feeder cable and Test Set RF I/O Connector.
2.	Power On Aircraft and configure aircraft for weight off wheels.
3.	Power Up: Press the POWER Key to power the Test Set. Press SETUP Control Key to display setup screens. Continue pressing SETUP Control Key to cycle to SETUP-XPDR Screen. Use NEXT PARAM and PREV PARAM Soft Keys to select each parameter.
4.	Select RF PORT: Set to DIRECT CONNECT.
5.	Select DIR CABLE LOSS: Set to loss found on cable.
6.	Select UUT ADDRESS: Set to AUTO. NOTE: If aircraft is on the ground set to MANUAL and enter in MANUAL ADDRESS. Mode S all-calls do not work when the aircraft is on the ground.
7.	Select DIVERSITY: Set to ON.
8.	Select CHECK CAP: Set to YES.
9.	Select PWR LIM: Set to FAR 43.
10.	Select DECODER TEST: Set to ON.

STEP	PROCEDURE
1.	Press XPDR Mode Key until the XPDR ENCODER Screen is displayed.
2.	Use DATA Keys or SELECT SOURCE Soft Key to select XPDR.
3.	Connect Test Set. Refer to 1-1-2, for Antenna Setup. Refer to 1-1-2, for Direct Connect Setup.
4.	Press RUN TEST Soft Key.

4.4.7 XPDR SETUP ANTENNA COUPLER CONNECT

STEP	PROCEDURE	STEP	PROCEDURE
1.	<p>Connect Antenna Coupler to Aircraft Antenna.</p> <ul style="list-style-type: none"> Place Coupler over the antenna, guiding antenna into the slot on the bottom of the coupler. Push Coupler firmly against the aircraft skin until the black rubber gasket on the rim of the coupler is completely depressed tightly against the aircraft. Lock coupler into place by pushing white lever on the side of the coupler into a down and locked position. <p>NOTE: Coupler must be tightly pressed and locked in place for Test Set to function correctly. Coupler will lock into place when the black rubber gasket is not completely depressed against the aircraft, but the Test Set will not measure functions accurately.</p>	7.	Select COUPLER LOSS: Set to loss found on coupler.
		8.	Select UUT ADDRESS: Set to AUTO. NOTE: If aircraft is on the ground set to MANUAL and enter in MANUAL ADDRESS. Mode S all-calls do not work when the aircraft is on the ground.
		9.	Select DIVERSITY: Set to ON.
		10.	Select CHECK CAP: Set to YES.
		11.	Select PWR LIM: Set to FAR 43.
		12.	Select DECODER TEST: Set to ON.
2.	<p>Connect long RF coaxial cable between the Antenna Coupler and Test Set RF I/O Connector.</p> <p>NOTE: If aircraft is on the ground set to MANUAL and enter in MANUAL ADDRESS. Mode S all-calls do not work when the aircraft is on the ground.</p> <p>NOTE: It is advisable to use the Antenna Shield or disconnect and terminate UUT antenna not being tested. This will prevent uninhibited transmission that may affect ATC operations.</p>		
3.	Power On Aircraft and configure aircraft for weight off wheels.		
4.	<p>Power Up: Press the POWER Key to power the Test Set.</p> <p>Press SETUP Control Key to display setup screens. Continue pressing SETUP Control Key to cycle to SETUP-XPDR Screen. Use NEXT PARAM and PREV PARAM Soft Keys to select each parameter.</p>		
5.	Select RF PORT: Select DIR W/COUPLER		
6.	Select CPL CABLE LOSS: Set to loss found on cable.		

4.4.8 "OVER THE AIR" GROUND TEST PROCEDURE (UUT Aircraft Altitude Reporting System □ Airfield Altitude)

STEP	PROCEDURE
1.	Press XPDR Mode Key to display XPDR Auto Test Screen. The Test Set shows displays the results of the last XPDR Auto Test if run since last Power-up.
2.	Perform XPDR Setup Screen procedure (para 1-2-4.4.2) setting RF Port to ANTENNA.
3.	Perform CONFIG selection procedure (para 1-2-4.3.1).
4.	Perform Directional Antenna Use procedure (para 1-2-4.5). Position Test Set Antenna facing UUT antenna at XPDR Setup Screen ANT RANGE.
5.	Shield with Antenna Shield or disconnect and terminate UUT antenna not being tested. Refer to Appendix J. Deactivate other area transponders or position transponders at least three times the XPDR Setup Screen ANT RANGE from the Test Set Antenna.
6.	Press RUN/STOP Soft Key to run XPDR Auto Test. TESTING in the line above the soft keys indicates test is running.
7.	Press RUN/STOP Soft Key at any time to stop test (non-resumable).
8.	Verify XPDR Auto Test indicates PASS or FAIL on DISPLAY. Verify squawk codes, altitudes, Mode S address, VS and FS status, country, and tail number.
9.	Verify squawk codes, altitudes, Mode S address, VS and FS status, country, and tail number.

NOTE: The Antenna Shield provides at least 20 dB of isolation, ensuring airborne TCAS equipped aircraft do not detect UUT at altitude, causing false RA's and TA's. The 20 dB isolation of the antenna shield may cause various tests to fail, which is normal.

4.4.9 "OVER THE AIR" SIMULATED ALTITUDE TEST PROCEDURE (UUT Aircraft Altitude Reporting System > Airfield Altitude ["Pumped Up"])

STEP	PROCEDURE
1.	Press XPDR Mode Key to display XPDR Auto Test Screen. Test Set displays results of last XPDR Auto Test if run since last Power-up.
2.	Perform XPDR Setup Screen procedure, setting RF I/O Connector to ANTENNA (para 1-2-4.4.2). Set ANT RANGE to □□20 ft (6.1 m).
3.	Perform CONFIG selection procedure (para 1-2-4.3.1).
4.	Perform Directional Antenna procedure (para 1-2-4.5). Position Test Set Antenna facing UUT antenna at XPDR Setup Screen ANT RANGE.
5.	Shield both UUT antennas with Antenna Shields or disconnect and terminate UUT Antenna not being tested. Deactivate other area transponders or position transponders >50 ft (15.24 m) from the Test Set antenna.
6.	Press RUN/STOP Key to run XPDR Auto Test. TESTING in the line above the soft keys indicates test is running.
7.	Press RUN/STOP Key at any time to stop test (non-resumable). Otherwise, Auto Test runs until all tests are complete.
8.	XPDR Auto Test will indicate a FAIL on DISPLAY.
9.	Verify squawk codes, altitudes, Mode S address, VS and FS status, country, and tail number.

NOTE: The Antenna Shield provides at least 20 dB of isolation, ensuring airborne TCAS equipped aircraft do not detect UUT at altitude, causing false RA's and TA's. The 20 dB isolation of the antenna shield may cause various tests to fail, which is normal.

4.5 ADS-B GENERAL

Automatic Dependent Surveillance Broadcast (ADS-B) is a technology where aircraft avionics broadcasts the aircraft position, altitude, velocity, and other parameters completely autonomously.

The system is automatic because the pilot is not involved in initiating broadcasts.

The service is dependent on the aircraft position determination system.

The application is surveillance, both air-ground and air-air.

When ADS-B is used, aircraft and other vehicles continuously broadcast a message including position, heading, velocity and intent. Other users may include obstacles transmitting a position message. Aircraft, ground-based stations, and other users monitoring the channels can receive the information and use it in a wide variety of applications. Because of this potential for broad utilization, a system using ADS-B is most often discussed as a replacement for or an augmentation to current methods of monitoring aeronautical traffic.

To understand the full capability of ADS-B, consider how the current Air Traffic Control system creates information. The radar measures the range and bearing of an aircraft. Bearing is measured by the position of the rotating radar antenna when it receives a response to its interrogation from the aircraft, and range is measured by the time it takes for the radar to receive the interrogation response. The antenna beam becomes wider as the aircraft get farther away, making the position information less accurate. Additionally, detecting changes in aircraft velocity requires several radar sweeps that are spaced several seconds apart.

In contrast, a system using ADS-B creates and listens for periodic position and intent reports from aircraft. These reports are generated and distributed using precise instruments, such as the global positioning system (GPS) and Mode S transponders, meaning integrity of the data is no longer susceptible to the range of the aircraft or the length of time between radar sweeps. The enhanced accuracy of the information will be used to improve safety, support a wide variety of applications, and increase airport and airspace capacity.

4.5.1 ADS-B/GICB MODES

The IFR 6000 provides flight line test capability for receiving (ADS-B MON mode), decoding, and displaying full ADS-B DO-260/A/B DF17/DF18 extended squitter transmissions from Mode S transponders or DF18 extended squitters from 1090 MHz emitters. Capability to generate (ADS-B GEN mode) full DO-260/A/B DF17/DF18 extended squitter transmissions for testing ADS-B receivers is provided. A GICB mode fully decodes and displays all Enhanced Surveillance BDS register contents. The ADS-B/GICB is a Sub-Mode of XPDR Mode.

4.5.2 ADS-B SETUP

The SETUP-ADS-B screen is accessed by pressing the ADS-B SETUP Soft Key on the SETUP-XPDR screen. The SETUP-ADS-B screen allows the setting of operational parameters for the ADS-B/GICB functional Mode.

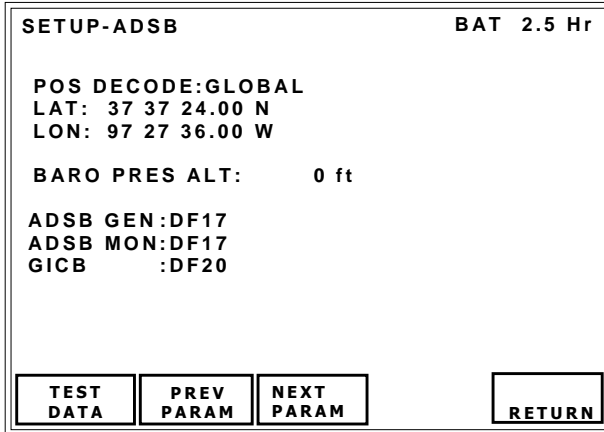

NOTE: Enter Setup Screen information before conducting test operations.

STEP	PROCEDURE
------	-----------

- | | |
|----|--|
| 1. | Press SETUP Key until the SETUP-XPDR Screen is displayed |
| 2. | Press ADSB SETUP Soft Key. |
| 3. | Set the parameters by pressing NEXT PARAM. Press PREV PARAM to select the field. Use DATA Keys to slew the data. Parameters are: |

STEP	PROCEDURE
------	-----------

- | | |
|----|---|
| ● | <p>POS DECODE:</p> <p>With GLOBAL selected simulated or decoded Latitude and Longitude will use the Global algorithm. BDS 0,6 requires a local LAT and LONG to resolve CPB positional algorithm ambiguity.</p> <p>With LOCAL selected, simulated or decoded Latitude and Longitude (BDS 0,5 and BDS 0,6) will use the local algorithm which requires a local LAT and LONG to be entered to resolve CPR positional algorithm ambiguity.</p> |
| ● | LAT: |
| ● | Local Latitude of UUT in Degrees, Minutes and Seconds, East or West. |
| ● | LONG: |
| ● | Local Longitude of UUT in Degrees, Minutes and Seconds, North or South. |
| ● | BARO PRES ALT:
Select the Barometric Altitude. |
| ● | ADSB GEN: |
| ● | Select Extended squitter type that test set will transmit, DF17 or DF18. |
| ● | ADSB MON: |
| ● | Select Extended squitter type that test set will receive DF17 or DF18. |
| ● | GICB: |
| ● | Select DF20 or DF21 for GICB BDS transfer. |
| 4. | Press the RETURN softkey to display the previous screen. |

SETUP TEST DATA

The SETUP-ADS-B Screen allows storage and recall of all SETUP-ADS-B test screens, including measurement data. There are twelve storage memories. The first storage memory retains the last power down data and cannot be overwritten. The last five are defined by the Test Set operator.

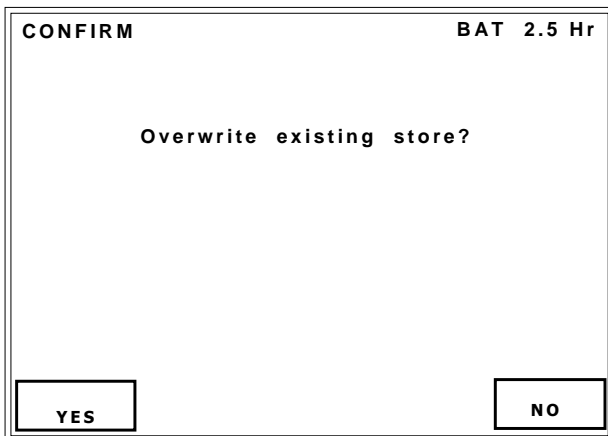
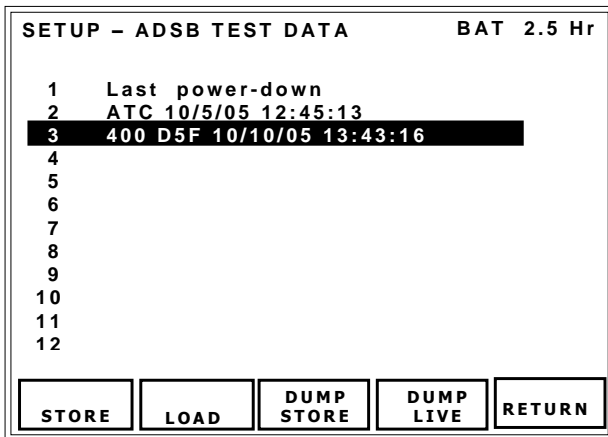

Data Storage Procedure:

- | STEP | PROCEDURE |
|------|---|
| 1. | Press SETUP Select Key until SETUP – XPDR Screen is displayed. Press ADSB SETUP Soft Key to display SETUP ADS-B Screen. |
| 2. | Press TEST DATA Soft Key to display SETUP-ADSB Test Data Screen. |
| 3. | Use DATA Keys to select the required store. Press STORE Soft Key to display CONFIRM Screen. |
| 4. | Press YES Soft Key to confirm overwrite. SETUP STORE NAME Screen is displayed. Store name can be blank. |
| 5. | Use DATA Keys to select the character line. Use DATA Keys to select desired character. |
| 6. | Press CHAR SELECT Soft Key to add selected character to the end of name string. Press BACK SPACE Soft Key to delete the selected character. |
| 7. | Press ENTER Soft Key to store name and display SETUP-ADSB TEST DATA Screen. |
| 8. | Press XPDR Mode Key until ADS-B MAIN menu is displayed. |

Data Recall Procedure:

1. Press SETUP Select Key until SETUP – XPDR Screen is displayed. Press ADSB SETUP Soft Key to display SETUP ADS-B Screen.
2. Press TEST DATA Soft Key to display SETUP-ADSB Test Data Screen.
3. Press RECALL Soft Key to recall test data. Press XPDR Mode Key until ADSB MAIN menu is displayed.
4. Use DATA Keys to select the desired Storage location. Press STORE Soft Key to display CONFIRM Screen if overwriting previously saved data or to display the SETUP STORE NAME Screen if the storage location is currently unused.

NOTE: The STORE soft key is not displayed while storage location 1 is selected.

4.5.3 ADS-B/GICB/UAT MAIN

Press the XPDR mode key twice to display the ADS-B/GICB/UAT Main Menu.

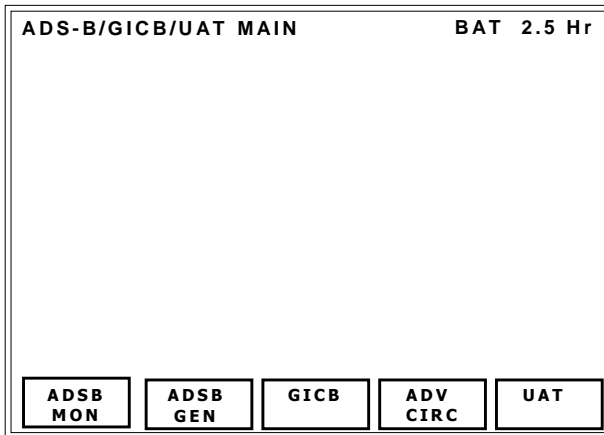

Press the ADS-B MON softkey to display the ADS-B MON list screen. Press the GICB softkey to display the GICB list screen.

4.5.4 ADS-B MON

The ADS-B MON mode of operation receives Transponder DF17 or Ground Emitter DF18 extended squitters, either via the Antenna port or RF I/O port. The squitters are captured in a buffer, decoded and displayed.

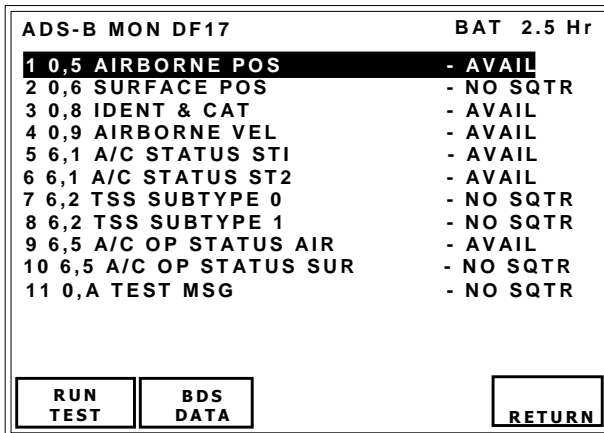

The ADS-B MON screen displays supported squitters that are identified by BDS register number and an abbreviated name. Status of the received squitter is displayed to the right of the squitter name. Indications are AVAIL (squitter has been captured), NO SQTR (Squitter available but not captured), NOT CAP (transponder has identified squitter is not supported by transponder/subsystem).

TEST SCREEN DESCRIPTIONS

ADS-B MON BDS 0,5

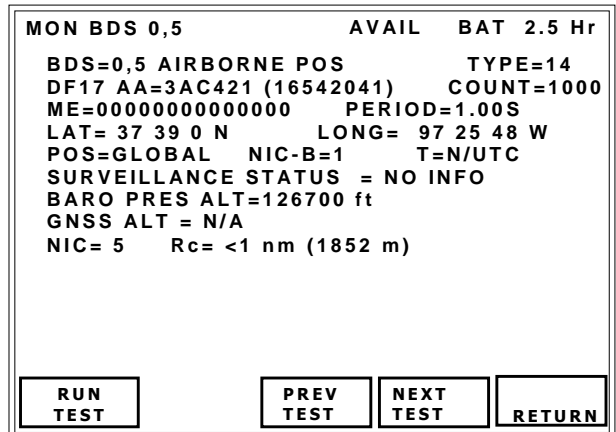

BDS: Indicates which BDS register is being displayed followed by its description. 0,5=Extended Squitter Airborne Position.

TYPE: Specifies class and accuracy of data. Refer to table A-2 RTCA DO-260B.

NOTE: Refer to ICAO Annex 10, Vol III, Part 1, Chapter 5 and RTCA-DO-260, DO-260A and DO-260B for detailed description of data fields.

NOTE: The airborne position decode, including the global mode, has multiple valid results. It is necessary to set a 'reference' lat/long on the ADSB SETUP Screen that is close to the test set's current location for the decode to work correctly.

DF17/18: Receives extended squitter decodes and displays airborne position

NOTE: ADLP (Air Data Link Processor) must be installed or transponder must have embedded ADLP, to receive data from subsystem.

NOTE: Installation must be in the airborne state to transmit airborne position.

AA (Aircraft Address) in HEX and (OCTAL)

COUNT

Indications: Displays total squitters received since test was run, range 0 to 9999.

ME (Message Field)

Indications: Displays in 14 digit HEX format.

PERIOD (Period)

Indications: Displays DF17/18 squitter period in seconds.

LAT (Encoded Latitude)

Indications: Unambiguous Latitude decoded using Local algorithm or Compact Position Reporting (CPR) algorithm depending on Position setting.

LONG (Encoded Longitude)

Indications: Unambiguous Longitude decoded using Local algorithm or Compact Position Reporting (CPR) algorithm depending on Position setting.

POS (Position Decode)

Indications:

GLOBAL (if Global LAT/LONG not entered in ADS-B/GICB setup menu).

LOCAL (if Local LAT/LONG is entered in ADS-B/GICB setup menu).

NIC-B (Navigation Integrity Category – Supplement B) – DO-260B only, Refer to Table 17

SAF (Single Antenna Flag) – DO-260A only

Indications:

0=Dual Antenna

1=Single Antenna

T (Time Sync to UTC)

Indications:

N/UTC (not UTC),

UTC.

SURVEILLANCE STATUS

Indications:

NO INFO (No Information),

SPI (Special Position Identification),

PERM ALERT (Permanent Alert

(Emergency)),

TEMP ALERT (Temporary Alert (change in Mode identity code)).

BARO PRESS ALT (Barometric Pressure Altitude)

Indications:

N/A

Displayed for types 9 to 18, range –1000 to 126700 ft.

GNSS ALTITUDE.

Indications:

N/A

Displayed for types 20 to 22, RANGE -1000 TO 126700 ft.

NIC (Navigation Integrity Category) DO-260A or DO-260B

NUC (Navigation Uncertainty Category) DO-260

Indications:

Refer to Table 17

Rc (Radius of Containment) DO-260A or DO-260B

HPL (Horizontal Protection Limit) DO-260

Indications:

Refer to Table 17

ADS-B MON BDS 0,6

MON BDS 0,6		AVAIL BAT 2.5 Hr	
BDS=0,6 SURFACE POS		TYPE=8	
DF17 AA=3AC421 (16542041)		COUNT=1000	
ME=000000000000		PERIOD=10.00 S	
LAT= 37 39 00 N		LONG= 97 25 48 W	
MOVMENT= 2kts		T=N/UTC	
HDG=230 deg		POS=GLOBAL	
NIC= 7		Rc= <0.2nm (370.4m)	
RUN TEST	PREV TEST	NEXT TEST	RETURN

BDS: Indicates which BDS register is being displayed followed by its description.

0,6=Extended Squitter Surface Position.

TYPE: Identifies the ADS-B Message Type.

NOTE: Refer to ICAO Annex 10, Vol III, Part 1, Chapter 5 and RTCA-DO-260, DO-260A and DO-260B for detailed description of data fields.

NOTE: The surface position decode, including the global mode, has multiple valid results. It is necessary to set a 'reference' lat/long on the ADSB SETUP Screen that is close to the test set's current location for the decode to work correctly.

DF17/18: Receives extended squitter decodes and displays surface position.

NOTE: Installation must be in the ground state to transmit surface position.

NOTE: When starting the test on the MON BDS 0,6 screen, ensure that the MANUAL AA in the SETUP-XPDR screen is set to the UUT address. See Section 4.4.2 SETUP.

AA (Aircraft Address) in HEX and (OCTAL)

COUNT

Indications: Displays total squitters received since test was run

ME message field displayed in 14-digit HEX format.

PERIOD

Indications: Displays DF17/18 squitter period in seconds.

LAT (Encoded Latitude)

Indications: Unambiguous Latitude decoded using Local algorithm or Compact Position Reporting (CPR) algorithm depending on Position setting.

LONG (Encoded Longitude)

Indications: Unambiguous Longitude decoded using Local algorithm or Compact Position Reporting (CPR) algorithm depending on Position setting.

MOVEMENT

Indications (DO-260A):

NO INFO (No Information Available),

STOPPED

0.125-<1 Kt,

1-<2 Kt,

2-<15 Kt,

15-<70 Kt,

70-<100 Kt,

100-<175 Kt,

>175 Kt,

DECELERATING,

ACCELERATING,

BACKING UP

Indications (DO-260B):

Refer to Table 18

T (Time Sync to UTC)

Indications:

N/UTC (Not UTC),

UTC

HDG (Heading)

Indications: 0 to 357 Degrees or N/A if HDG Status not valid.

POS (Position Decode)

Indications:

GLOBAL (if Global LAT/LONG not entered in ADS-B/GICB setup menu).

LOCAL (if Local LAT/LONG is entered in ADS-B/GICB setup menu).

NIC (Navigation Integrity Category) DO-260A or DO-260B

NUC (Navigation Uncertainty Category) DO-260

Indications:

Refer to Table 17

Rc (Radius of Containment) DO-260A or DO-260B

HPL (Horizontal Protection Limit) DO-260

Indications:

Refer to Table 17

Type Code	Subtype Code	NIC Supplement			Format (Message Type)	Horizontal Containment Radius Limit (R_c)	Navigation Integrity Category (NIC)
		A	B	C			
0	Not Present	Not Applicable			No Position Information (Airborne or Surface Position Messages)	R_c Unknown	NIC=0
1	Not Present	Not Applicable			Aircraft Identification and Category Message	Not Applicable	Not Applicable
2							
3							
4							
5	Not Present	0	--	0	Surface Position Message	$R_c < 7.5$ m	NIC=11
6		0	--	0		$R_c < 25$ m	NIC=10
7		1	--	0		$R_c < 75$ m	NIC=9
		0	--	0		$R_c < 0.1$ NM (185.25 m)	NIC=8
8		1	--	1		$R_c < 0.2$ NM (370.4 m)	NIC=7
		1	--	0		$R_c < 0.3$ NM (555.6 m)	NIC=6
		0	--	1		$R_c < 0.6$ NM (1111.2 m)	
		0	--	0		$R_c \geq 0.1$ NM (1111.2 m) or unknown	NIC=0
9	Not Present	0	0	--	Airborne Position Message	$R_c < 7.5$ m	NIC=11
10		0	0	--		$R_c < 25$ m	NIC=10
11		1	1	--		$R_c < 75$ m	NIC=9
		0	0	--		$R_c < 0.1$ NM (185.25 m)	NIC=8
12		0	0	--		$R_c < 0.2$ NM (370.4 m)	NIC=7
		0	1	--		$R_c < 0.3$ NM (555.6 m)	NIC=6
13		0	0	--		$R_c < 0.5$ NM (925.6 m)	
		1	1	--		$R_c < 0.6$ NM (1111.2 m)	
14		0	0	--		$R_c < 1.0$ NM (1852 m)	NIC=5
15		0	0	--		$R_c < 2$ NM (3.704 km)	NIC=4
16		1	1	--		$R_c < 4$ NM (7.408 km)	NIC=3
		0	0	--		$R_c < 8$ NM (14.816 km)	NIC=2
17		0	0	--		$R_c < 20$ NM (37.04 km)	NIC=1
18		0	0	--		$R_c \geq 20$ NM (37.04 km) or unknown	NIC=0

"TYPE" Subfield Code Definitions (DF=17 or 18) for DO-260B
Table 17a

Type Code	Subtype Code	NIC Supplement			Format (Message Type)	Horizontal Containment Radius Limit (R_c)	Navigation Integrity Category (NIC)
19	0	Not Applicable			Reserved	Not Applicable	Not Applicable
	1-4				Airborne Velocity Message		
	5-7				Reserved		
20	Not Present	0	0	--	Airborne Position Message	$R_c < 75$ m	NIC=11
21		0	0	--		$R_c < 25$ m	NIC=10
22		0	0	--		$R_c \geq 25$ m or unknown	NIC=0

"TYPE" Subfield Code Definitions (DF=17 or 18) for DO-260B
Table 17a

Type Code	Subtype Code	NIC Supplement	Format (Message Type)	Horizontal Containment Radius Limit (R_c)	Navigation Integrity Category (NIC)
0	Not Present	Not Applicable	No Position Information (Airborne or Surface Position Messages)	R_c Unknown	NIC=0
1	Not Present	Not Applicable	Aircraft Identification and Category Message	Not Applicable	Not Applicable
2					
3					
4					
5	Not Present	0	Surface Position Message	$R_c < 7.5$ m	NIC=11
6		0		$R_c < 25$ m	NIC=10
7		1		$R_c < 75$ m	NIC=9
		0		$R_c < 0.1$ NM (185.2 m)	NIC=8
8		0		$R_c \geq 0.1$ NM (185.2 m) or unknown	NIC=0
9	Not Present	0	Airborne Position Message	$R_c < 7.5$ m & VPL < 11 m	NIC=11
10		0		$R_c < 25$ m & VPL < 37.5 m	NIC=10
11		1		$R_c < 75$ m & VPL < 112 m	NIC=9
		0		$R_c < 0.1$ NM (185.2 m)	NIC=8
12		0		$R_c < 0.2$ NM (370.4 m)	NIC=7
13		1		$R_c < 0.6$ NM (1111.2 m)	NIC=6
		0		$R_c < 0.5$ NM (926 m)	
14		0		$R_c < 1.0$ NM (1852 m)	NIC=5
15		0		$R_c < 2$ NM (3.704 km)	NIC=4
16		1		$R_c < 4$ NM (7.408 km)	NIC=3
		0		$R_c < 8$ NM (14.816 km)	NIC=2
17		0		$R_c < 20$ NM (37.04 km)	NIC=1
18		0		$R_c \geq 20$ NM (37.04 km) or unknown	NIC=0

"TYPE" Subfield Code Definitions (DF=17 or 18) for DO-260A
Table 17b

Type Code	Subtype Code	NIC Supplement	Format (Message Type)	Horizontal Containment Radius Limit (R_c)	Navigation Integrity Category (NIC)
19	0	Not Applicable	Reserved	Not Applicable	Not Applicable
	1-4		Airborne Velocity Message		
	5-7		Reserved		
20	Not Present	0	Airborne Position Message	$R_c < 75$ m	NIC=11
21		0		$R_c < 25$ m	NIC=10
22		0		$R_c \geq 25$ m or VPL ≥ 37.5 m or RC or VPL are unknown	NIC=0

"TYPE" Subfield Code Definitions (DF=17 or 18) for DO-260A
Table 17b

Type Code	Format (Message Type)	Horizontal Containment Radius Limit (R _c)	Horizontal(u) and Vertical(v) Position Error	Navigation Uncertainty Category (NUC)
0	No Position Information (Airborne or Surface Position Messages)	Not Applicable	Not Applicable	NUC=0
1	Aircraft Identification and Category Message	Not Applicable	Not Applicable	Not Applicable
2				
3				
4				
5	Surface Position Message	HPL < 7.5 m	u < 3 m	NUC=9
6		HPL < 25 m	3 m ≤ u < 10 m	NUC=8
7		HPL < 185.2 m (0.1 NM)	10 m ≤ u < 92.6 m (0.05 NM)	NUC=7
8		HPL > 185.2 m (0.1 NM) or unknown	92.6 m (0.05 NM) ≤ u	NUC=6
9	Airborne Position Message	HPL < 7.5 m	u < 3 m	NUC=9
10		25 m ≤ HPL < 25 m	3 m ≤ u < 10 m	NUC=8
11		25 m ≤ HPL < 185.2 m (0.1 NM)	10 m ≤ u < 92.6 m (0.05 NM)	NUC=7
12		185.2 m (0.1 NM) ≤ HPL < 370.4 m (0.2 NM)	92.6 m (0.05 NM) ≤ u < 185.2 m (0.1 NM)	NUC=6
13		380.4 m (0.2 NM) ≤ HPL < 926 m (0.5 NM)	185.2 m (0.1 NM) ≤ u < 463 m (0.25 NM)	NUC=5
14		926 m (0.5 NM) ≤ HPL < 1852 m (1.0 NM)	463 m (0.25 NM) ≤ u < 926 m (0.5 NM)	NUC=4
15		1852 m (1.0 NM) ≤ HPL < 3704 m (2.0 NM)	926 m (0.5 NM) ≤ u < 1.852 km (1.0 NM)	NUC=3
16		7.704 km (2.0 NM) ≤ HPL < 18.52 km (10 NM)	1.852 km (1.0 NM) ≤ u < 9.26 km (5.0 NM)	NUC=2
17		18.52 km (10 NM) ≤ HPL < 37.04 km (20 NM)	9.26 km (5.0 NM) ≤ u < 18.52 km (10.0 NM)	NUC=1
18		HPL > 37.04 km (20 NM)	18.52 km (10.0 NM) ≤ u	NUC=0

“TYPE” Subfield Code Definitions (DF=17 or 18) for DO-260
Table 17c

Type Code	Format (Message Type)	Horizontal Containment Radius Limit (R_c)	Horizontal(u) and Vertical(v) Position Error	Navigation Uncertainty Category (NUC)
19	Airborne Velocity Message	Not Applicable	Not Applicable	Not Applicable
20	Airborne Position Message	HPL < 7.5 m	u < 3 and v < 4 m	NUC=9
21		HPL < 25 m	u < 10 m and v < 15 m	NUC=8
22		HPL ≥ 25 m	u ≥ 10 m or v ≥ 15 m	TBD

“TYPE” Subfield Code Definitions (DF=17 or 18) for DO-260
Table 17c

Coding (decimal)	Meaning	Quantization
0	No movement information available	
1	Aircraft stopped (Ground Speed = 0 knots)	
2	0 knots < Ground Speed ≤ 0.2315 km/h (0.125 kt)	
3 - 8	0.2315 km/h (0.125 kt) < Ground Speed ≤ 1.852 km/h (1 kt)	0.2700833 km/h steps
9 - 12	1.852 km/h (1kt) < Ground Speed ≤ 3.704 km/h (2 kt)	0.436 km/h (0.25 kt) steps
13 - 38	3.704 km/h (2 kt) < Ground Speed ≤ 27.78 km/h (15 kt)	0.926 km/h (0.50 kt) steps
39 - 93	27.78 km/h (15 kt) < Ground Speed ≤ 129.64 km/h (70 kt)	1.852 km/h (1.00 kt) steps
94 - 108	129.64 km/h (70 kt) < Ground Speed ≤ 185.2 km/h (100 kt)	3.704 km/h (2.00 kt) steps
109 - 123	185.2 km/h (100 kt) < Ground Speed ≤ 324.1 km/h (175 kt)	9.26 km/h (5.00 kt) steps
124	324.1 km/h (175 kt) < Ground Speed	
125	Reserved for Aircraft Decelerating	
126	Reserved for Aircraft Accelerating	
127	Reserved for Aircraft Backing-Up	

"MOVEMENT" Subfield in ADS-B Surface Position Messages
Table 18

Lateral Axis GPS Antenna Offset Encoding				
"ME" Bit (message Bit)			Upper Bound of the GPS Antenna Offset Along Lateral (Pitch) Axis Left or Right of Longitudinal (Roll) Axis	
33 (65)	34 (66)	35 (67)		
0 = left 1 = right	Encoding		Direction	(meters)
	Bit 1	Bit 0		
0	0	0	LEFT	NO DATA
	0	1		2
	1	0		4
	1	1		6
1	0	0	RIGHT	0
	0	1		2
	1	0		4
	1	1		6

Lateral Axis GPS Antenna Offset Encoding
Table 19

Longitudinal Axis GPS Antenna Offset Encoding					
"ME" Bit (Message Bit)					Upper Bound of the GPS Antenna Offset Along Longitudinal (Roll) Axis Aft From Aircraft Nose
36 (68)	37 (69)	38 (70)	39 (71)	40 (72)	
Encoding					(meters)
Bit 4	Bit 3	Bit 2	Bit 1	Bit 0	
0	0	0	0	0	NO DATA
0	0	0	0	1	Position Offset Applied by Sensor
0	0	0	1	0	2
0	0	0	1	1	4
0	0	1	0	0	6
*	*	*	*	*	***
*	*	*	*	*	***
*	*	*	*	*	***
1	1	1	1	1	60

Longitudinal Axis GPS Antenna Offset Encoding
Table 20

ADS-B MON BDS 0,8

MON BDS 0,8		AVAIL BAT 2.5 Hr	
BDS=0,8 IDENT & CAT		TYPE=4	
DF17 AA=3AC421 (16542041)		COUNT=1000	
ME=00000000000000		PERIOD=10.00 S	
AIS= 6103B3D35672			
FLIGHT ID =XPN34512			
EMIT CAT SET=A			
EMIT CAT=LARGE			
<input type="button" value="RUN TEST"/>		<input type="button" value="PREV TEST"/> <input type="button" value="NEXT TEST"/> <input type="button" value="RETURN"/>	

BDS: Indicates which BDS register is being displayed followed by its description.
 0,8=Extended Squitter Identification and Category.

TYPE: Specifies class and accuracy of data. Refer to table A-2 RTCA DO-260B.

NOTE: Refer to ICAO Annex 10, Vol III, Part 1, Chapter 5 and RTCA-DO-260, DO-260A and DO-260B for detailed description of data fields.

DF17,18: Receives extended squitter decodes and displays identification and category.

NOTE: ADLP (Air Data Link Processor) must be installed or transponder must have embedded ADLP, to receive data from subsystem.

AA (Aircraft Address) in HEX and (OCTAL) COUNT

Indications: Displays total squitters received since test was run.

ME message field displayed in 14 digit HEX format.

PERIOD

Indications: Displays DF17/18 squitter period in seconds.

EMIT CAT SET (ADS-B Emitter Category Set).

Indications: D,C,B,A.

EMIT CAT (ADS-B Emitter Category).

Indications: SMALL, MEDIUM or LARGE

EMIT CAT A:

NO ADS-B EMITTER INFO,
 LIGHT,
 SMALL,
 LARGE,
 HIGH VORTEX,
 HEAVY,
 HIGH PERFORMANCE,
 ROTORCRAFT,

EMIT CAT B:

NO ADS-B EMITTER INFO,
 GLIDER/SAILPLANE,
 LIGHTER-THAN-AIR,
 PARACHUTIST/SKYDIVER,
 ULTRALIGHT/HANG-GLIDER,
 RESERVED,
 UNMANNED AERIAL VEHICLE,
 SPACE VEHICLE.

EMIT CAT C:

NO ADS-B EMITTER INFO,
 SURFACE EMERGENCY VEHICLE,
 SURFACE SERVICE VEHICLE,
 FIXED GND/TETHERED OBSTR,
 CLUSTER OBSTR,
 LINE OBSTR,
 RESERVED,
 RESERVED

EMIT CAT D:

RESERVED,
 RESERVED,
 RESERVED,
 RESERVED,
 RESERVED,
 RESERVED,
 RESERVED

AIS (Aircraft Identity Subfield) HEX field containing BDS plus flight ID.

FLIGHT ID Indications: 8 ICAO character field.

MON BDS 0,9

MON BDS 0,9		AVAIL BAT 2.5 Hr	
BDS=0,9 AIRBORNE VEL		TYPE=19	
DF17 AA=3AC421 (16542041)		COUNT=1000	
ME=00000000000000		PERIOD=10.00 S	
E-W VEL=1000 kts E		NACV=4	
N-S VEL=1000 kts N		HDG=N/A	
SUB TYPE=1-VEL OVR GND NORM			
VERT RATE= 64 ft/min			
GEO ALT DIFF FROM BARO= -3125 ft			
SOURCE=BARO		INTENT CHANGE=YES	
AIRSPEED=N/A		AIRSPEED TYPE=N/A	
RESERVED=YES			
RUN TEST	PREV TEST	PREV TEST	RETURN

BDS: Indicates which BDS register is being displayed followed by its description.
0,9=Extended Squitter Airborne Velocity.

TYPE: Specifies class and accuracy of data. Refer to table A-2 RTCA DO-260B.

NOTE: Refer to ICAO Annex 10, Vol III, Part 1, Chapter 5 and RTCA-DO-260, DO-260A and DO-260B for detailed description of data fields.

DF17,18: Receives extended squitter decodes and displays Airborne Velocity.

AA (Aircraft Address) in HEX and (OCTAL)

COUNT

Indications: Displays total squitters received since test was run.

ME message field displayed in 14-digit HEX format.

PERIOD

Indications: Displays DF17/18 squitter period in seconds.

NOTE: ADLP (Air Data Link Processor) must be installed, or transponder must have embedded ADLP, to receive data from subsystem.

NOTE: Installation must be in the airborne state to transmit airborne velocity.

SUB TYPE (Subtype Coding).

NOTE: ICAO DOC 9688 (First edition of ICAO Mode S Specific Service manual) not supported.

Indications:

0=NOT ASSIGNED

1=VEL OVR GND NORM (Velocity Over Ground Normal),

2=VEL OVER GND SUPER (Velocity Over Ground Supersonic),

3=AIR SPD NORM (Airspeed Normal),

4=AIR SPD HDG SUPER (Airspeed Supersonic),

5=NOT ASSIGNED,

6=NOT ASSIGNED,

7=NOT ASSIGNED

E-W VEL (East-West Velocity).

Indications:

N/A (Not Available),

0 to >1021 Kts (subtype 1),

0 to >4086 Kts (subtype 2),

NOTE: Followed by E (East) or W (West) direction identifier.

NACV (Navigation Accuracy Category – Velocity)

Indications:

0=Unknown or ≥ 10 m/s

1= < 10 m/s

2= < 3 m/s

3= < 1 m/s

4= < 0.3 m/s

N-S VEL (North-South Velocity)

Indications:

N/A (Not Available),

0 to >1021 Kts (subtype 1),

0 to >4086 Kts (subtype 2),

NOTE: Followed by N (North) or S (South) direction identifier.

HDG (Heading).

Indications:

N/A (Not Available),

0.0 to 359.6 Degrees.

VERT RATE (Vertical Rate).

Indications:

N/A (Not Available),

< -32608 to > 32608 ft/min (subtypes 1 and 2).

GEO ALT DIFF FROM BARO (Geo Altitude Difference from Barometric Altitude).

Indications:

< -3137 ft to > 3137 ft

SOURCE (Source of Vertical rate).

Indications:

N/A (Not Available),
BARO (Barometric Source),
GEO (i.e., GPS Source)

INTENT CHANGE (Intent Change Flag)

Indications:

YES
NO

AIRSPEED.

Indications:

N/A (Not Available),
0 to >1021 Kts (subtype 3)
0 to >4086 Kts (subtype 4)

AIR SPEED TYPE.

Indications:

IAS (Indicated Airspeed),
TAS (True Airspeed)

RESERVED – DO-260B only
IFR CAP ADS-B/CLASS A1 – DO-260A only

Indications:

YES
NO

ADS-B MON BDS 0, A

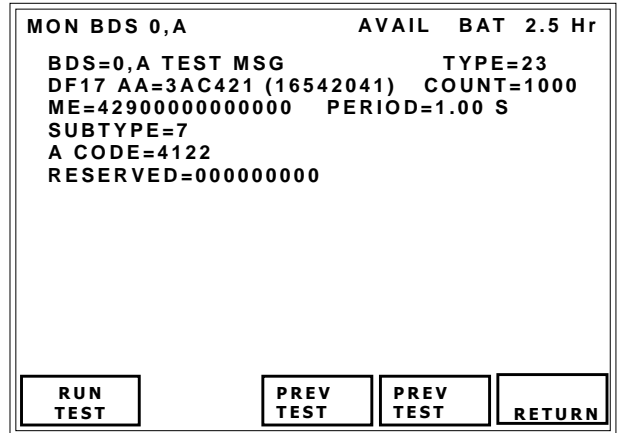

BDS: Indicates which BDS register is being displayed followed by its description. 0,A=Extended Squitter Event-Driven Register.

TYPE: Specifies class and accuracy of data. Refer to table A-2 RTCA DO-260B.

NOTE: Refer to ICAO Annex 10, Vol III, Part 1, Chapter 5 and RTCA-DO-260, DO-260A and DO-260B for detailed description of data fields.

DF17,18/19: Receives extended squitter decodes and displays ADS-B Test Message.

NOTE: ADLP (Air Data Link Processor) must be installed, or transponder must have embedded ADLP, to receive data from subsystem.

AA (Aircraft Address) in HEX and (OCTAL) COUNT

Indications: Displays total squitters received since test was run.

ME message field displayed in 14-digit HEX format.

PERIOD

Indications: Displays DF17/18/19 squitter period in seconds.

SUB TYPES (Subtype Coding).

Indications:

0 (ICAO DOC 9688 (First edition of ICAO Mode S Specific Service manual) not supported. Refer to DO-260/DO-260A, change 1.

A CODE

DO-260A only
Decodes and displays Mode A 4096 code. Range: 0000 to 7777.

RESERVED

Decodes and displays 9 Hex character Reserved field.

ADS-B MON BDS 6,1 ST1

MON BDS 6,1 ST1		AVAIL	BAT 2.5 Hr
BDS=6,1 A/C STATUS ST1		TYPE=28	
DF17 AA=3AC421 (16542041)	COUNT=1000		
ME=00000000000000	PERIOD=10.00 S		
SUBTYPE=1-EMERGENCY/PRIOR STATUS			
EMERGENCY/PRIOR CODE:0-NO EMERGENCY			
MODE A (4096) CODE=0000			
RESERVED=000000000			
RUN TEST	PREV TEST	PREV TEST	RETURN

MODE A (4096) CODE – DO-260B only
4-digit OCTAL field.

Indications:
0000 to 7777

RESERVED subfield, 12-digit HEX field
containing contents of bits 12 to 56 for
DO-260A, 25-56 for DO-260B.

SUB TYPE (Subtype Coding).

Indications:

0=NO INFO
1=EMERGENCY/PRIOR STATUS
2=TCAS RA BROADCAST
3-7=RESERVED

BDS: Indicates which BDS register is being
displayed followed by its description.

6,1=Extended Squitter Aircraft Status.

TYPE: Specifies class and accuracy of data.
Refer to table A-2 RTCA DO-260B.

NOTE: Refer to ICAO Annex 10, Vol III,
Part 1, Chapter 5 and RTCA-DO-
260, DO-260A and DO-260B for
detailed description of data fields.

DF17,18: Receives extended squitter
decodes and displays Aircraft Status.

NOTE: ADLP (Air Data Link Processor) must
be installed, or transponder must
have embedded ADLP, to receive
data from subsystem.

AA (Aircraft Address) in HEX and (OCTAL)

COUNT

Indications: Displays total squitters received
since test was run.

ME message field displayed in 14-digit HEX
format.

PERIOD

Indications: Displays DF17/18 squitter period
in seconds.

EMERG/PRIOR CODE (Emergency/Priority
Status Coding).

Indications:

0=NO EMERGENCY,
1=GENERAL EMERGENCY,
2=LIFEGUARD/MEDICAL,
3=MINIMUM FUEL,
4=NO COMM,
5=UNLAWFUL INTERFNC,
6=DOWNED AIRCRAFT,
7=RESERVED.

ADS-B MON BDS 6,1 ST2

MON BDS 6,1 ST2		AVAIL	BAT 2.5 Hr
BDS=6,1 A/C STATUS		TYPE=28	
DF17 AA=3AC421 (16542041)	COUNT=1000		
ME=00000000000000	PERIOD=10.00 S		
SUBTYPE=0-NO INFO			
TTI=	TIDR=		
TIDA=	RAT=		
TIDB=	RAC=		
ARA=	RAC=		
MTE=	RAC=		
THREAT ADDR=			
RUN TEST	PREV TEST	PREV TEST	RETURN

BDS: Indicates which BDS register is being displayed followed by its description.
6,1=Extended Squitter Aircraft Status.

TYPE: Specifies class and accuracy of data. Refer to table A-2 RTCA DO-260B.

NOTE: Refer to ICAO Annex 10, Vol III, Part 1, Chapter 5 and RTCA-DO-260, DO-260A and DO-260B for detailed description of data fields.

DF17,18: Receives extended squitter decodes and displays Aircraft Status.

NOTE: ADLP (Air Data Link Processor) must be installed, or transponder must have embedded ADLP, to receive data from subsystem.

AA (Aircraft Address) in HEX and (OCTAL)
COUNT

Indications: Displays total squitters received since test was run.

ME message field displayed in 14-digit HEX format.

PERIOD
Indications: Displays DF17/18 squitter period in seconds.

TTI (Threat Type Indicator) DO-260B only
Indications:

- 0=No identity data in TID
- 1=TID contains a Mode S transponder address
- 2=TID contains altitude, range and bearing data.
- 3=Not assigned

TIDA (Threat Identity Data – Altitude)
DO-260B only

Indications:
Mode C altitude of the threat.
-1000 to 126700 ft res: 100 ft

TIDB (Threat Identity Data – Bearing)
DO-260B only

Indications:
N/A (not available)
0 to 360 deg

RAT (RA Terminated) DO-260B only
Indications:

- 0=ACAS is currently generating the RA indicated in the ARA subfield.
- 1=The RA indicated by the ARA subfield has been terminated.

TIDR (Threat Identity Data – Range)
DO-260B only

Indications:
N/A (not available)
<0.05 nm
0.10 to 12.50 nm, resolution 0.10 nm
>12.55 nm

ARA (Active Resolution Advisories)
DO-260B only

Indications:
14-bit subfield indicating characteristics of the RA.

MTE (Multiple Threat Encounter)
DO-260B only

Indications:
0=One threat is being processed by the resolution logic (when ARA bit 41=0)
1=Two or more simultaneous threats are being processed by the resolution logic.

RAC (RACS Record) 4-bit subfield.
DO-260B only

Indications:
Bit 55=Do not pass below
Bit 56=Do not pass above
Bit 57=Do not turn left
Bit 58=Do not turn right
0=Inactive
1=Active

THREAT ADDR (Aircraft Address of the Threat) DO-260B only

Indications:
Bits 63-86.

ADS-B MON BDS 6,2 ST0

MON BDS 6,2 ST 0		AVAIL BAT 2.5 Hr	
BDS=6,2 TSS SUBTYPE 0 TYPE=29			
DF17 AA=3AC421 (16542041) COUNT=40			
ME=E97FFFF8001404 PERIOD=1.25 s			
VERT DATA/SOURCE INFO=FMS/NAV			
TARG ALT CAP=HLDG ALT-ACP-FMS/RNAV			
VERT MODE IND=ACQUIRING SIL=1			
TARG ALT TYPE=MSL NIC BARO=1			
TARG ALT= 31000 ft TARG HDG=240 deg			
TCAS/ACAS OPERATIONAL=YES RAA=NO			
HORIZ DATA AVAL/SOURCE IND=MCP/FCU			
HORIZ MODE IND=MAINTAINING NAC=0			
EMERG/PRIOR CODE=UNLAWFUL INTERFNC			
RUN TEST	PREV TEST	PREV TEST	RETURN

BDS: Indicates which BDS register is being displayed followed by its description.
6,2 ST0=Target State and Status Information.

TSS SUBTYPE (Target State and Status Subtype)

Indications:
0=DO-260A

TYPE: Specifies class and accuracy of data. Refer to table A-2 RTCA DO-260B.

NOTE: Refer to ICAO Annex 10, Vol III, Part 1, Chapter 5 and RTCA-DO-260, DO-260A and DO-260B for detailed description of data fields.

DF17,18: Receives extended squitter decodes and displays Target State.

NOTE: ADLP (Air Data Link Processor) must be installed, or transponder must have embedded ADLP, to receive data from subsystem.

AA (Aircraft Address) in HEX and (OCTAL)

COUNT

Indications: Displays total squitters received since test was run.

ME message field displayed in 14-digit HEX format.

PERIOD

Indications: Displays DF17/18 squitter period in seconds.

NOTE Installation must be in the airborne state to transmit target state and status.

NOTE: Autopilot must be engaged and stimulated by sensor data for some fields to display data.

VERT DATA/SOURCE INFO (Vertical Data Available/Source Indicator) DO-260B only

Indications:

NOT VALID

MCP/FCU (Mode Control Panel/Flight Control Unit),

HLD ALT (Holding Altitude),

FMS/RNAV (FMS/RNAV System).

TARG ALT CAP (Target Altitude Capability) DO-260A only

Indications:

HLDG ALT (Capability for reporting Holding altitude only),

HLDG ALT-ACP (Capability for reporting either Holding altitude or Autopilot control panel selected altitude),

HLDG ALT-ACP-FMS/RNAV (Capability for reporting either Holding altitude or Autopilot control panel selected altitude, or any FMS/RNAV level off altitude).

RESERVED

VERT MODE IND (Vertical Mode Indicator) DO-260A only

Indications:

UNKNOWN, (Unknown Mode or Information unavailable),

ACQUIRING (Acquiring Mode),

MAINTAINING (Capturing or Maintaining Mode).

RESERVED

SIL (Surveillance Integrity Level)

Indications:

0 (Unknown),

1 (1×10^{-3}) per flight),

2 (1×10^{-5}) per flight),

3 (1×10^{-7}) per flight)

TARG ALT TYPE (Target Altitude Type)

DO-260A only

Indications:

FL (Flight Level)

MSL (Mean Sea Level)

NIC BARO (Navigation Integrity Baro)

Indications:

0 (Gillham Not Cross Checked)

1 (Gillham Cross Checked)

TARG ALT (Target Altitude) DO-260A only

Indications:

-1000 ft to 100,000 ft

TARGET HDG (Target Heading Angle)

DO-260A only

Indications:

0 to 359 degrees.

INVALID

TCAS/ACAS OPERATIONAL (TCAS/ACAS

Operational)

Indications:

YES,

NO.

RAA (TCAS/ACAS Resolution Advisory

Active) DO-260A only

Indications:

YES,

NO.

HORIZ DATA AVAIL/SOURCE IND (Horizontal

Data Available/Source Indicator)

DO-260A only

Indications:

NOT VALID (No Valid Horizontal Target State

Data is available),

MCP/FCU (Mode Control Panel/Flight Control

Unit selected track angle),

MAINTAIN (Maintain Current Heading or

Track angle),

FMS/RNAV (FMS/RNAV System)

HORIZ MODE IND (Horizontal Mode

Indicator) DO-260A only

Indications:

UNKNOWN (Unknown Mode or Information

unavailable),

ACQUIRING (Acquiring Mode),

MAINTAINING (Capturing or Maintaining

Mode),

RESERVED

NAC (Navigation Accuracy Category -

Position)

Indications:

0=EPU \geq 18.52 km (\geq 10NM)

1=EPU \leq 18.52 km (10NM)

2=EPU $<$ 7.408 km (4NM)

3=EPU $<$ 3.704 km (2NM)

4=EPU $<$ 1852 m (1NM)

5=EPU $<$ 926 m (0.5NM)

6=EPU $<$ 555.6 m (0.3NM)

7=EPU $<$ 185.2 m (0.1NM)

8=EPU $<$ 92.6 m (0.05NM)

9=EPU $<$ 30 m

10=EPU $<$ 10 m

11=EPU $<$ 3 m

12=Reserved

13=Reserved

14=Reserved

15=Reserved

EMERG/PRIOR CODE (Emergency/Priority

Status Coding) DO-260A only

Indications:

0=NO EMERGENCY,

1=GENERAL EMERGENCY,

2=LIFEGUARD/MEDICAL,

3=MINIMUM FUEL,

4=NO COMM,

5=UNLAWFUL INTERFNC,

6=DOWNED AIRCRAFT,

7=RESERVED.

ADS-B MON BDS 6,2 ST1

MON BDS 6,2 ST 1		AVAIL BAT 2.5 Hr	
BDS=6,2 TSS SUBTYPE 1		TYPE=29	
DF17 AA=3AC421 (16542041)		COUNT=1000	
ME=00000000000000		PERIOD=10.00 s	
SUBTYPE=1		SIL=0	
		SIL SUP=1	
NAC=0		LNAV=0	
		VNAV =1	
MCP=1		AUTO P=1	
		AHME=1	
AP MODE=1		TCAS OP=NO	
SELECTED ALTITUDE=21792 ft		TYPE=1	
BARO PRESSURE=843.2 mb		NIC BARO=0	
SELECTED HEADING = - 59.7 deg			
SELECTED HEADING STATUS=1			
RESERVED ADS-R FLAG=1			
<input type="button" value="RUN TEST"/>		<input type="button" value="PREV TEST"/>	
		<input type="button" value="PREV TEST"/>	
		<input type="button" value="RETURN"/>	

BDS: Indicates which BDS register is being displayed followed by its description.

6,2 ST1=Target State and Status Information.

TSS SUBTYPE (Target State and Status Subtype)

Indications:

1= DO-260B

TYPE: Specifies class and accuracy of data.

Refer to table A-2 RTCA DO-260B.

NOTE: Refer to ICAO Annex 10, Vol III, Part 1, Chapter 5 and RTCA-DO-260, DO-260A and DO-260B for detailed description of data fields.

DF17,18: Receives extended squitter decodes and displays Target State.

NOTE: ADLP (Air Data Link Processor) must be installed, or transponder must have embedded ADLP, to receive data from subsystem.

AA (Aircraft Address) in HEX and (OCTAL)

COUNT

Indications: Displays total squitters received since test was run.

ME message field displayed in 14-digit HEX format.

PERIOD

Indications: Displays DF17/18 squitter period in seconds.

NOTE Installation must be in the airborne state to transmit target state and status.

NOTE: Autopilot must be engaged and stimulated by sensor data for some fields to display data.

SUBTYPE= 1

SIL (Source Integrity Level) Indications:

- 0 (Unknown),
- 1 (1×10^{-3} per flight),
- 2 (1×10^{-5} per flight),
- 3 (1×10^{-7} per flight)

SIL SUP (SIL Supplement) DO-260B only
Indications:

- 0=Probability of exceeding NIC radius of containment is based on "per hour"
- 1=Probability of exceeding NIC radius of containment is based on "per sample"

NAC (Navigation Accuracy Category - Position)

Indications:

- 0= $EPU \geq 18.52$ km (≥ 10 NM)
- 1= $EPU \leq 18.52$ km (10NM)
- 2= $EPU < 7.408$ km (4NM)
- 3= $EPU < 3.704$ km (2NM)
- 4= $EPU < 1852$ m (1NM)
- 5= $EPU < 926$ m (0.5NM)
- 6= $EPU < 555.6$ m (0.3NM)
- 7= $EPU < 185.2$ m (0.1NM)
- 8= $EPU < 92.6$ m (0.05NM)
- 9= $EPU < 30$ m
- 10= $EPU < 10$ m
- 11= $EPU < 3$ m
- 12=Reserved
- 13=Reserved
- 14=Reserved
- 15=Reserved

LNAV (Lateral Navigation Engaged)

DO-260B only

Indications:

- 0=LNAV Mode is NOT Active
- 1=LNAV Mode is Active

VNAV (Vertical Navigation Engaged)

DO-260B only

Indications:

- 0=VNAV Mode is NOT Active or Unknown
- 1=VNAV Mode is Active

MCP (Status of MCP/FCU) DO-260B only

Indications:

- 0=No Mode Information is being provided in "ME" bits 48, 49, 50 or 52 (Message bits 80, 81, 82 or 84)
- 1=Mode Information is deliberately being provided in "ME" bits 48, 49, 50 or 52 (Message bits 80, 81, 82 or 84)

AUTO P (Autopilot Engaged)

Indications:

0=Autopilot is NOT Engaged or Unknown (e.g., not actively coupled and flying the aircraft)

1=Autopilot is Engaged (e.g., actively coupled and flying the aircraft)

AHME (Altitude Hold Mode) DO-260B only

Indications:

0=Altitude Hold Mode is NOT Active or Unknown

1=Altitude Hold Mode is Active

AP MODE (Approach Mode) DO-260B only

Indications:

0=Approach Mode is NOT Active or Unknown

1=Approach Mode is Active

TCAS OP (TCAS Operational)

Indications:

0=TCAS System is NOT Operational (Any time RI \neq 3 or 4)

1=TCAS System is Operational (RI=3 or 4)

SELECTED ALTITUDE (Selected Altitude)

DO-260B only

Indications:

0 to 65472 ft Res 32 ft

TYPE (Selected Altitude Type) DO-260B only

Indications:

0=MCP/FCU

1=FMS

BARO PRESSURE (Barometric Pressure)

DO-260B only

Indications:

INVALID

800 to 1208 mb Res 0.8 mb

NIC BARO (Navigation Integrity Category - Baro)

Indications:

0=Barometric Altitude Invalid

1= Barometric Altitude Valid

SELECTED HEADING (Selected Heading)

DO-260B only

Indications:

+/- 180 deg Res 180/256 (0.703125 deg)

SELECTED HEADING STATUS

(Selected Heading Status) DO-260B only

Indications:

0=Invalid

1=Valid

ADS-B MON BDS 6,5 AIR

MON BDS 6,5 AIR		AVAIL BAT 2.5 Hr	
BDS=6,5 A/C OP STATUS AIR TYPE =31			
DF17 AA=123456 (00432126) COUNT =11			
ME=F82AAA2AAA4AAF PERIOD=1.57 s			
SUBTYPE=0-AIR		VERSION=2-DO-260B	
CC FMT =2AAA ARV=1 TS=0 1090=0			
UAT=1 TC=2 ADSR=0 TCAS OP=1			
OM FMT=0 SDA=0 SAF=0 ATC=1			
RA=1 ID= NO			
HRZ REF=MAG NORTH NIC-A=0 GVA=2			
NIC-BARO=1		SIL SUP=1 SIL=2	
NACP=10-EPU < 0.0054		ADSR(56)=1	
RUN TEST	PREV TEST	PREV TEST	RETURN

BDS: Indicates which BDS register is being displayed followed by its description.
6,5=Aircraft Operational Status, Airborne Subtype.

TYPE: Specifies class and accuracy of data. Refer to table A-2 RTCA DO-260B.

NOTE: Refer to ICAO Annex 10, Vol III, Part 1, Chapter 5 and RTCA-DO-260, DO-260A and DO-260B for detailed description of data fields.

DF17/18: Displays which extended squitter is being received.
in seconds.

NOTE: ADLP (Air Data Link Processor) must be installed, or transponder must have embedded ADLP, to receive data from subsystem.

NOTE: Refer to RTCA/DO-260A, Appendix A, section §A.1.8, Figure A-10, replaces "BDS 6,3" with "BDS 6,5." Both BDS 6,3 and 6,5 are supported, and data displayed is identical.

COUNT
Indications: Displays total squitters received since test was run.

ME message field displayed in 14-digit HEX format.

PERIOD
Indications: Displays DF17/18 squitter period

SUBTYPE

Indications:

- 0=AIR (Airborne Status message),
- 1=SUR (Surface Status message),
- 2=RESERVED,
- 3=RESERVED,
- 4=RESERVED,
- 5=RESERVED,
- 6=RESERVED,
- 7=RESERVED,

VERSION (MOPS Version Number)

Indications:

- 0-DO-260
- 1-DO-260A
- 2-DO-260B

CC FMT (Capability Class)

- ME BITS 9-24 (airborne)
- ME BITS 9-20 (surface)
- 0000-FFFF (airborne)
- 000-FFF (surface)

ARV (Air Referenced Velocity Report Capability) Only Available when Subtype= Airborne.

Indications:

- N/A (Surface)
- 1 (Capability of sending messages to support Air-Referenced velocity reports),
- 0 (No Capability of sending messages to support Air-Referenced velocity reports)

TS (Target State Report Capability) Only Available when Subtype= Airborne

Indications:

- N/A (Surface)
- 1 (Capability of sending messages to support Target State Reports),
- 0 (No Capability of sending messages to support Target State Reports)

CDTI – DO-260A

- 1090 (1090 In Capability) – DO-260B
- 0=Not Capable
- 1=Capable

Aircraft has ADS-B 1090ES Receive

UAT (UAT In Capability)

Only Available when Subtype= Airborne

Indications:

- 0= (No Capability to receive ADS-B UAT messages)
- 1= (Aircraft has capability to receive ADS-B UAT messages)

TC (Target Change Report Capability) Only
Available when Subtype= Airborne.

Indications:

N/A (Surface)

0 (No capability for sending messages to support trajectory change reports) ,

1 (Capability of sending messages to support TC+0 report only),

2 (Capability of sending information for multiple TC reports).

3 (Reserved)

ADSR (Reserved for ADS-R flag)

Bit 20 of the ME field.

Included in Class Capabilities.

Indications:

0=Not Active

1=Active

Not TCAS – DO-260A

TCAS OP (TCAS Operational) – DO-260B

Indications:

0=(TCAS/ACAS Not Operational)

1=(TCAS/ACAS Operational)

OM FMT (Operational Mode Subfield)

Indications:

0 (TCAS RA Active, IDENT Switch Active, Receiving ATC Services)

1 (Reserved)

2 (Reserved)

3 (Reserved)

SDA (System Design Assurance Data)

DO-260B only

Indications:

0=Unknown or No Safety Effect

1=Minor

2=Major

3=Hazardous

SAF (Single Antenna Flag) DO-260B only

Indications:

0=Dual Antenna

1=Single Antenna

ATC (Receiving ATC Services)

Indications:

1 (Aircraft receiving ATC services),

0 (Aircraft not receiving ATC services).

RA (TCAS RA Active)

Indications:

0=(TCAS II or ACAS resolution advisory inactive)

1=(TCAS II or ACAS resolution advisory active)

ID (Ident Switch)

Indications:

YES (Ident active),

NO (Ident not active).

HRZ REF (Horizontal Reference Direction)

Indications:

TRUE NORTH

MAG NORTH (Magnetic North)

NIC-A (Navigation Integrity Category – Supplement A)

Indications:

DO-260A and DO-260B, Refer to Table 17

BAQ (Barometric Altitude Quality) DO-260A

Only available when Subtype=Airborne

GVA (Geometric Vertical Accuracy) DO-260B

Only available when Subtype=Airborne

Indications:

0=Unknown or >150 m

1= \leq 150 m

2= \leq 45 m

3=Reserved

NIC BARO (Navigation Integrity Baro)

Indications:

N/A (Surface)

0 (Gillham Not Cross Checked)

1 (Gillham Cross Checked)

SIL SUP (SIL Supplement) DO-260B only

Indications:

0=Probability of exceeding NIC radius of containment is based on “per hour”

1=Probability of exceeding NIC radius of containment is based on “per sample”

SIL (Surveillance Integrity Level)

Indications:

0 (Unknown),

1 (1×10^{-3} per flight),

2 (1×10^{-5} per flight),

3 (1×10^{-7} per flight)

NACP

Indications:

0=EPU>18.52 km (>10NM)

1=EPU<18.52 km (10NM)

2=EPU<7.408 km (4NM)

3=EPU<3.704 km (2NM)

4=EPU<1852 m (1NM)

5=EPU<926 m (0.5NM)

6=EPU<555.6 m (0.3NM)

7=EPU<185.2 m (0.1NM)

8=EPU<92.6 m (0.05NM)

9=EPU<30 m (0.016NM)

10=EPU<10 m (0.0054NM)

11=EPU<3 m (0.0016NM)

12=Reserved

13=Reserved

14=Reserved

15=Reserved

ADSR(56) (Reserved for ADS-R flag)

Bit 56 of the ME field.

Indications:

0=Not Active

1=Active

ADS-B MON BDS 6,5 SUR

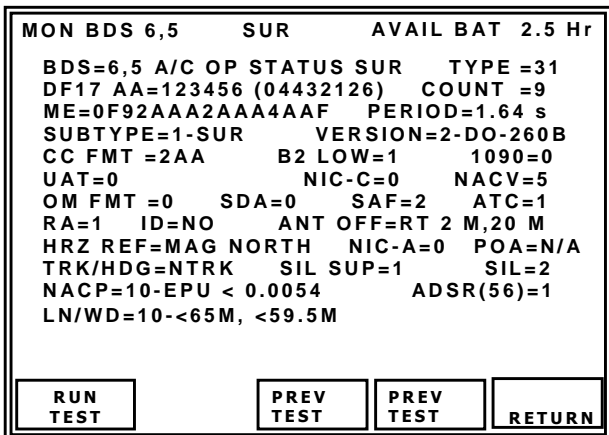

BDS: Indicates which BDS register is being displayed followed by its description.
6,5=Aircraft Operational Status, Surface Subtype.

TYPE: Specifies class and accuracy of data. Refer to table A-2 RTCA DO-260B.

NOTE: Refer to ICAO Annex 10, Vol III, Part 1, Chapter 5 and RTCA-DO-260, DO-260A and DO-260B for detailed description of data fields.

DF17/18: Displays which extended squitter is being received.

NOTE: ADLP (Air Data Link Processor) must be installed or transponder must have embedded ADLP, to receive data from subsystem.

NOTE: Refer to RTCA/DO-260A, Appendix A, section §A.1.8, Figure A-10, replaces “BDS 6,3” with “BDS 6,5.” Both BDS 6,3 and 6,5 are supported and data displayed is identical.

COUNT
Indications: Displays total squitters received since test was run.

ME message field displayed in 14 digit HEX format.

PERIOD
Indications: Displays DF17/18 squitter period in seconds.

SUBTYPE

Indications:
0=AIR (Airborne Status message),
1=SUR (Surface Status message),
2=RESERVED,
3=RESERVED,
4=RESERVED,
5=RESERVED,
6=RESERVED,
7=RESERVED,

VERSION (MOPS Version Number)
Indications:
0-DO-260
1-DO-260A
2-DO-260B

CC FMT (Capability Class)
ME BITS 9-24 (airborne)
ME BITS 9-20 (surface)
0000-FFFF (airborne)
000-FFF (surface)

B2 LOW
Indications:
N/A (Airborne)
0 (≥ 70 W)
1 (< 70 W)

CDTI – DO-260A
1090 (1090 In Capability) – DO-260B
0=Not Capable
1=Capable
Aircraft has ADS-B 1090ES Receive

UAT (UAT In Capability)
Only available when Subtype=Airborne
Indications:
0=(No Capability to receive ADS-B UAT messages)
1=(Aircraft has capability to receive ADS-B UAT messages)

NIC-C (Navigation Integrity Category – Supplement C) DO-260B only
Only available when Subtype=Surface
Indications: Refer to Table 17

NACV (Navigation Accuracy Category – Velocity) DO-260B only
Only available when Subtype= Surface
Indications:
0=Unknown or ≥ 10 m/s
1= < 10 m/s
2= < 3 m/s
3= < 1 m/s
4= < 0.3 m/s

OM FMT (Operational Mode Subfield)
Indications:
0 (TCAS RA Active, IDENT Switch Active, Receiving ATC Services)
1 (Reserved)
2 (Reserved)
3 (Reserved)

SDA (System Design Assurance Data)
DO-260B only
Indications:
0=Unknown or No Safety Effect
1=Minor
2=Major
3=Hazardous

SAF (Single Antenna Flag)
Indications:
0=Dual Antenna
1=Single Antenna

ATC (Receiving ATC Services)
Indications:
1 (Aircraft receiving ATC services),
0 (Aircraft not receiving ATC services).

RA (TCAS RA Active)
Indications:
0=(TCAS II or ACAS resolution advisory inactive)
1=(TCAS II or ACAS resolution advisory active)

ID (Ident Switch)
Indications:
YES (Ident active),
NO (Ident not active).

ANT OFF (GPS Antenna Offset Data)
DO-260B only
Only available when Subtype= Surface
Refer to Tables 19 and 20.

HRZ REF (Horizontal Reference Direction)
Indications:
TRUE NORTH
MAG NORTH (Magnetic North)

NIC-A (Navigation Integrity Category – Supplement A)
Indications:
DO-260A only
0 (Rc unknown)
1 (Rc < 20 NM)
DO-260B only, Refer to Table 17

POA (Position Offset Applied) DO-260A only
Only available when Subtype= Surface
Indications:
N/A (Airborne)
0 (Position transmitted is not the ADS-B position reference point)
1 (Position transmitted is the ADS-B position reference point)

TRK/HDG (Used for surface ADS-B participants, surface position message heading or ground track determination bit)
Indications:
N/A (Airborne)
0 (Target Heading Reported)
1 (Track Angle Reported)

SIL SUP (SIL Supplement) DO-260B only
Indications:
0=Probability of exceeding NIC radius of containment is based on “per hour”
1=Probability of exceeding NIC radius of containment is based on “per sample”

SIL (Surveillance Integrity Level)
Indications:
0 (Unknown),
1 (1x10⁻³ per flight),
2 (1x10⁻⁵ per flight),
3 (1x10⁻⁷ per flight)

NACP
Indications:
0=EPU>18.52 km (>10NM)
1=EPU<18.52 km (10NM)
2=EPU<7.408 km (4NM)
3=EPU<3.704 km (2NM)
4=EPU<1852 m (1NM)
5=EPU<926 m (0.5NM)
6=EPU<555.6 m (0.3NM)
7=EPU<185.2 m (0.1NM)
8=EPU<92.6 m (0.05NM)
9=EPU<30 m (0.016NM)
10=EPU<10 m (0.0054NM)
11=EPU<3 m (0.0016NM)
12=Reserved
13=Reserved
14=Reserved
15=Reserved

ADSR(56) (Reserved for ADS-R flag)
Bit 56 of the ME field.
Indications:
0=Not Active
1=Active

LN/WD (Aircraft Length and Width)
Aircraft or Vehicle Length
Only available when Subtype= Surface
Indications: Length,Width
0=No Data or Unknown
1=<15m, <23m
2=<25m, <28.5m
3=<25m, <34m
4=<35m, <33m
5=<35m, <38m
6=<45m, <39.5m
7=<45m, <45m
8=<55m, <45m
9=<55m, <52m
10=<65m, <59.5m
11=<65m, <67m
12=<75m, <72m
13=<75m, <80m
14=<85m, <80m

4.5.5 ADVISORY CIRCULAR

The ADVISORY CIRCULAR mode of operation is a subset of the ADS-B MON and receives Transponder DF17 or Ground Emitter DF18 extended squitters, either via the Antenna port or RF I/O port. The squitters are captured in a buffer, decoded and displayed.

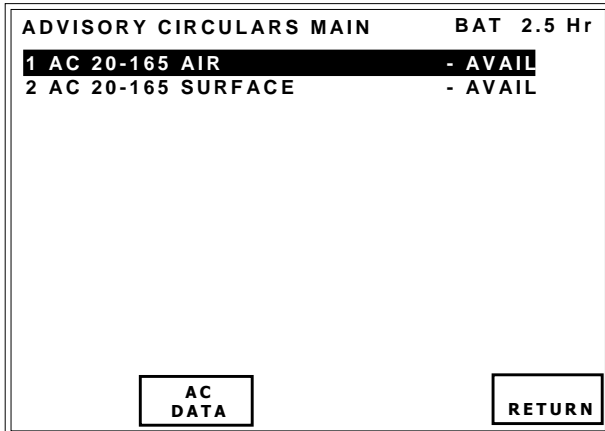

The ADVISORY CIRCULARS MAIN screen displays the supported tests. Status of the received squitter is displayed to the right of the squitter name. Indications are AVAIL (squitter has been captured), NO SQTR (Squitter available but not captured), NOT CAP (transponder has identified squitter is not supported by transponder/subsystem), NOT RUN (test has not been ran), BAD SETUP (ADS-B Version Number is earlier than DO-260B).

TEST SCREEN DESCRIPTIONS

ADV CIRC 20-165 AIR

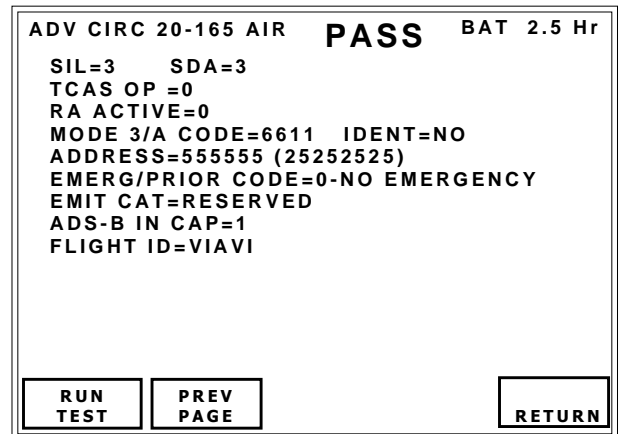
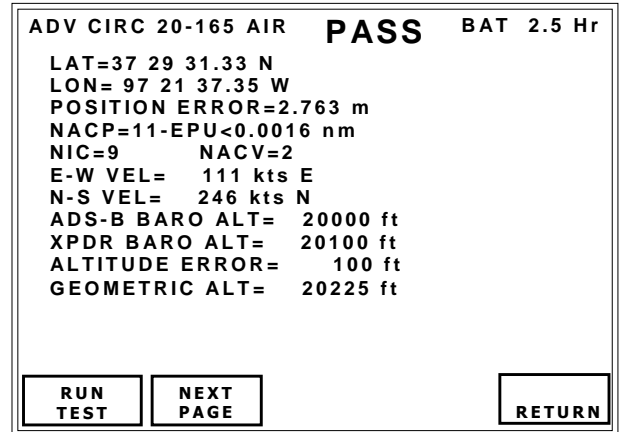

BDS 0,5=Extended Squitter Airborne Position is monitored for address, position, barometric altitude, and NIC Supplement-B. The Position Error is calculated with the Haversine formula with the position entered in the ADS-B setup as the reference.

NOTE: The maximum Position Error that can be detected is limited to 4294.967295 km. So the user is responsible for checking the decoded Airborne Position against the reference position (in ADSB Setup) for gross position discrepancy.

NIC is derived from the combination of BDS 0,5 Type code, NIC Supplement-B, and BDS 6,5 NIC Supplement-A. The Geometric Altitude is calculated by adding the Barometric Altitude from BDS 0,5 and the Geometric Height Difference from Barometric Altitude from BDS 0,9.

BDS 0,8=Extended Squitter Identification and Category is monitored for the Aircraft Emitter Category and Flight ID.

BDS 0,9=Extended Squitter Airborne Velocity is monitored for East-West Velocity, North-South Velocity, and Geometric Height Difference from Barometric Altitude.

BDS 6.1=Extended Squitter Aircraft Status Subtype 1 is monitored for Emergency State and Mode A Code.

BDS 6,5=Aircraft Operational Status is monitored for Source Integrity Level (SIL), System Design Assurance (SDA), ADS-B 1090ES Receive Capability, TCAS Operational, TCAS Resolution Advisory Active, Identification Switch Active, NIC Supplement-A, and Navigational Accuracy Category – Position.

The PASS/FAIL criteria is per Advisory Circular 20-165A, Section 4-1(c)

ADDRESS (Aircraft Address) in HEX and (OCTAL)

LAT (Encoded Latitude)

Indications: Unambiguous Latitude decoded using Local algorithm or Compact Position Reporting (CPR) algorithm depending on Position setting.

LON (Encoded Longitude)

Indications: Unambiguous Longitude decoded using Local algorithm or Compact Position Reporting (CPR) algorithm depending on Position setting.

NACP

Indications:

- 0=EPU>18.52 km (>10NM)
- 1=EPU<18.52 km (10NM)
- 2=EPU<7.408 km (4NM)
- 3=EPU<3.704 km (2NM)
- 4=EPU<1852 m (1NM)
- 5=EPU<926 m (0.5NM)
- 6=EPU<555.6 m (0.3NM)
- 7=EPU<185.2 m (0.1NM)
- 8=EPU<92.6 m (0.05NM)
- 9=EPU<30 m (0.016NM)
- 10=EPU<10 m (0.0054NM)
- 11=EPU<3 m (0.0016NM)
- 12=Reserved
- 13=Reserved
- 14=Reserved
- 15=Reserved

NIC (see Table 17)

NACV (Navigation Accuracy Category – Velocity)

Indications:

- 0=Unknown or ≥ 10 m/s
- 1=<10 m/s
- 2=<3 m/s
- 3= <1 m/s
- 4=<0.3 m/s

E-W VEL (East-West Velocity).

Indications:

- N/A (Not Available),
- 0 to >1021 Kts (subtype 1),
- 0 to >4086 Kts (subtype 2),

NOTE: Followed by E (East) or W (West) direction identifier.

N-S VEL (North-South Velocity)

Indications:

- N/A (Not Available),
- 0 to >1021 Kts (subtype 1),
- 0 to >4086 Kts (subtype 2),

NOTE: Followed by N (North) or S (South) direction identifier.

ADS-B BARO ALT (Barometric Pressure Altitude)

Indications:

N/A

Displayed for types 9 to 18, range –1000 to 126700 ft.

XPDR BARO ALT (Transponder Barometric Altitude) is the altitude received from a DF4 reply.

Indications:

N/A

Displayed for types 9 to 18, range –1000 to 126700 ft.

ALTITUDE ERROR is the difference of ADS-B BARO ALT and XPDR BARO ALT. The difference must be less than or equal to 125 feet per AC 20-165A, Section 4-1(c3).

GEOMETRIC ALT (Geometric Altitude) is the sum of ADS-B BARO ALT and GEOMETRIC HEIGHT DIFFERENCE FROM BARO ALT of BDS 0,9.

NOTE: It is the responsibility of the user to verify that the displayed geometric altitude matches the airfield height.

The Geometric Altitude will only be flagged as a failure on the test set if the Geometric Altitude cannot be calculated.

SIL (Surveillance Integrity Level)

Indications:

- 0 (Unknown),
- 1 (1×10^{-3} per flight),
- 2 (1×10^{-5} per flight),
- 3 (1×10^{-7} per flight)

SDA (System Design Assurance Data)

Indications:

- 0=Unknown or No Safety Effect
- 1=Minor
- 2=Major
- 3=Hazardous

Not TCAS – DO-260B

TCAS OP (TCAS Operational) – DO-260B

Indications:

- 0=(TCAS/ACAS Not Operational)
- 1=(TCAS/ACAS Operational)

RA ACTIVE (TCAS RA Active)

Indications:

- 0=(TCAS II or ACAS resolution advisory inactive)
- 1=(TCAS II or ACAS resolution advisory active)

MODE 3/A CODE – DO-260B only

4 digit OCTAL field.

Indications:

0000 to 7777

IDENT (Ident Switch)

Indications:

- YES (Ident active),
- NO (Ident not active).

EMERG/PRIOR CODE

Indications:

- 0=NO EMERGENCY,
- 1=GENERAL EMERGENCY,
- 2=LIFEGUARD/MEDICAL,
- 3=MINIMUM FUEL,
- 4=NO COMM,
- 5=UNLAWFUL INTERFNC,
- 6=DOWNED AIRCRAFT,
- 7=RESERVED.

EMIT CAT (ADS-B Emitter Category).

Indications:

EMIT CAT A:

- NO ADS-B EMITTER INFO,
- LIGHT,
- SMALL,
- LARGE,
- HIGH VORTEX,
- HEAVY,
- HIGH PERFORMANCE,
- ROTORCRAFT,

EMIT CAT B:

- NO ADS-B EMITTER INFO,
- GLIDER/SAILPLANE,
- LIGHTER-THAN-AIR,
- PARACHUTIST/SKYDIVER,
- ULTRALIGHT/HANG-GLIDER,
- RESERVED,
- UNMANNED AERIAL VEHICLE,
- SPACE VEHICLE.

EMIT CAT C:

- NO ADS-B EMITTER INFO,
- SURFACE EMERGENCY VEHICLE,
- SURFACE SERVICE VEHICLE,
- FIXED GND/TETHERED OBSTR,
- CLUSTER OBSTR,
- LINE OBSTR,
- RESERVED,
- RESERVED

EMIT CAT D:

- RESERVED,
- RESERVED,
- RESERVED,
- RESERVED,
- RESERVED,
- RESERVED,
- RESERVED

ADS-B IN CAP
 1090 (1090 In Capability) – DO-260B
 0=Not Capable
 1=Capable
 Aircraft has ADS-B 1090ES Receive
 Capability

FLIGHT ID Indications: 8 ICAO character
 field.

ADV CIRC 20-165 SUR

ADV CIRC 20-165 SUR		PASS	BAT 2.5 Hr
LAT=37 37 26.10 N LON= 97 27 40.86 W POSITION ERROR=4.451 m NACP=9-EPU<0.016 nm NIC=8 NACV=1 REPORTED MOVEMENT=0 kt TO <0.125 kt HEADING= 28 deg			
RUN TEST	NEXT PAGE	RETURN	

ADV CIRC 20-165 SUR		PASS	BAT 2.5 Hr
SIL=3 SDA=3 LEN/WIDTH=8-<55m, <45m RA ACTIVE=0 MODE 3/A CODE=7000 IDENT=NO ADDRESS=555555 (25252525) EMERG/PRIOR CODE=0-NO EMERGENCY EMIT CAT=HEAVY ADS-B IN CAP=1 FLIGHT ID=VIAVI			
RUN TEST	PREV PAGE	RETURN	

BDS 0,6=Extended Squitter Surface Position is monitored for address, position, Movement, and Heading. The Position Error is calculated with the Haversine formula with the position entered in the ADS-B setup as the reference.

NOTE: The maximum Position Error that can be detected is limited to 4294.967295 km. So the user is responsible for checking the decoded Airborne Position against the reference position (in ADSB Setup) for gross position discrepancy.

NIC is derived from the combination of NIC Supplement-A and NIC Supplement-C of BDS 6,5.

BDS 0,8=Extended Squitter Identification and Category is monitored for the Aircraft Emitter Category and Flight ID.

BDS 6.1=Extended Squitter Aircraft Status Subtype 1 is monitored for Emergency State and Mode A Code.

BDS 6,5=Aircraft Operational Status is monitored for Source Integrity Level (SIL), System Design Assurance (SDA), ADS-B 1090ES Receive Capability, TCAS Resolution Advisory Active, Identification Switch Active, NIC Supplement-A, Navigational Accuracy Category – Position, Navigational Accuracy Category – Velocity, and NIC Supplement-C.

The PASS/FAIL criteria is per Advisory Circular 20-165A, Section 4-1(c)

ADDRESS (Aircraft Address) in HEX and (OCTAL)

LAT (Encoded Latitude)

Indications: Unambiguous Latitude decoded using Local algorithm or Compact Position Reporting (CPR) algorithm depending on Position setting.

LON (Encoded Longitude)

Indications: Unambiguous Longitude decoded using Local algorithm or Compact Position Reporting (CPR) algorithm depending on Position setting.

NACP

Indications:

- 0=EPU>18.52 km (>10NM)
- 1=EPU<18.52 km (10NM)
- 2=EPU<7.408 km (4NM)
- 3=EPU<3.704 km (2NM)
- 4=EPU<1852 m (1NM)
- 5=EPU<926 m (0.5NM)
- 6=EPU<555.6 m (0.3NM)
- 7=EPU<185.2 m (0.1NM)
- 8=EPU<92.6 m (0.05NM)
- 9=EPU<30 m (0.016NM)
- 10=EPU<10 m (0.0054NM)
- 11=EPU<3 m (0.0016NM)
- 12=Reserved
- 13=Reserved
- 14=Reserved
- 15=Reserved

NIC (see Table 17)

NACV (Navigation Accuracy Category – Velocity)

Indications:

- 0=Unknown or ≥ 10 m/s
- 1=<10 m/s
- 2=<3 m/s
- 3=<1 m/s
- 4=<0.3 m/s

REPORTED MOVEMENT

Indications (DO-260A):

NO INFO (No Information Available), STOPPED

0.125-<1 Kt,

1-<2 Kt,

2-<15 Kt,

15-<70 Kt,

70-<100 Kt,

100-<175 Kt,

>175 Kt,

DECELERATING,

ACCELERATING,

BACKING UP

Indications (DO-260B):

Refer to Table 18

HEADING

Indications: 0 to 357 Degrees or N/A if HDG Status not valid.

SIL (Surveillance Integrity Level)

Indications:

0 (Unknown),

1 (1×10^{-3} per flight),

2 (1×10^{-5} per flight),

3 (1×10^{-7} per flight)

SDA (System Design Assurance Data)

Indications:

0=Unknown or No Safety Effect

1=Minor

2=Major

3=Hazardous

RA ACTIVE (TCAS RA Active)

Indications:

0=(TCAS II or ACAS resolution advisory inactive)

1=(TCAS II or ACAS resolution advisory active)

LEN/WIDTH (Aircraft Length and Width)

Aircraft or Vehicle Length

Indications: Length,Width

0=No Data or Unknown

1=<15m, <23m

2=<25m, <28.5m

3=<25m, <34m

4=<35m, <33m

5=<35m, <38m

6=<45m, <39.5m

7=<45m, <45m

8=<55m, <45m

9=<55m, <52m

10=<65m, <59.5m

11=<65m, <67m

12=<75m, <72m

13=<75m, <80m

14=<85m, <80m

MODE 3/A CODE – DO-260B only

4 digit OCTAL field.

Indications:

0000 to 7777

IDENT (Ident Switch)

Indications:

YES (Ident active),

NO (Ident not active).

EMERG/PRIOR CODE

Indications:

0=NO EMERGENCY,

1=GENERAL EMERGENCY,

2=LIFEGUARD/MEDICAL,

3=MINIMUM FUEL,

4=NO COMM,

5=UNLAWFUL INTERFNC,

6=DOWNED AIRCRAFT,

7=RESERVED.

EMIT CAT (ADS-B Emitter Category).

Indications:

EMIT CAT A:

NO ADS-B EMITTER INFO,

LIGHT,

SMALL,

LARGE,

HIGH VORTEX,

HEAVY,

HIGH PERFORMANCE,

ROTORCRAFT,

EMIT CAT B:

NO ADS-B EMITTER INFO,

GLIDER/SAILPLANE,

LIGHTER-THAN-AIR,

PARACHUTIST/SKYDIVER,

ULTRALIGHT/HANG-GLIDER,

RESERVED,

UNMANNED AERIAL VEHICLE,

SPACE VEHICLE.

EMIT CAT C:

NO ADS-B EMITTER INFO,

SURFACE EMERGENCY VEHICLE,

SURFACE SERVICE VEHICLE,

FIXED GND/TETHERED OBSTR,

CLUSTER OBSTR,

LINE OBSTR,

RESERVED,

RESERVED

EMIT CAT D:

RESERVED,

RESERVED,

RESERVED,

RESERVED,

RESERVED,

RESERVED,

RESERVED

ADS-B IN CAP

1090 (1090 In Capability) – DO-260B

0=Not Capable

1=Capable

Aircraft has ADS-B 1090ES Receive Capability

FLIGHT ID Indications: 8 ICAO character field.

4.5.6 ADS-B GEN

The ADS-B GEN mode of operation generates Transponder DF17 or Ground Emitter DF18 extended squitters, either via the Antenna port or RF I/O port. The squitters are encoded via data entered in individual data screens.

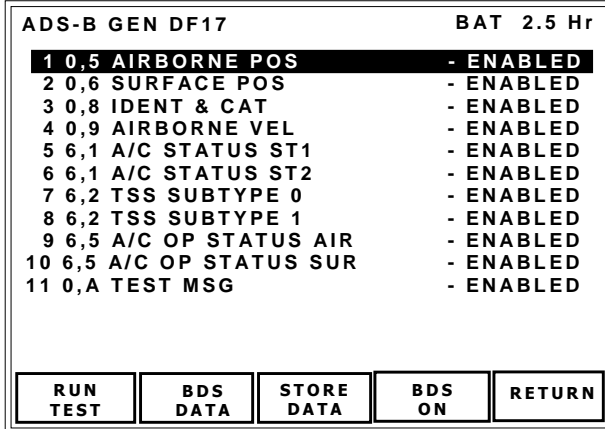

The ADS-B GEN screen displays supported squitters that are identified by BDS register number and an abbreviated name. Status of the generated squitter is displayed to the right of the squitter name. Selections are ENABLED (squitter will be generated) or DISABLED (Squitter will not be generated)

TEST SCREEN DESCRIPTIONS ADS-B GEN BDS 0,5

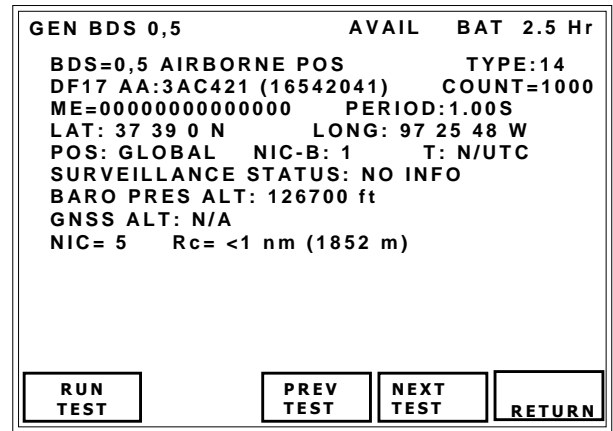

BDS: Indicates which BDS register is being displayed followed by its description.
0,5=Extended Squitter Airborne Position.

TYPE: Specifies class and accuracy of data. Refer to table A-2 RTCA DO-260B.

NOTE: Refer to ICAO Annex 10, Vol III, Part 1, Chapter 5 and RTCA-DO-260, DO-260A and DO-260B for detailed description of data fields.

NOTE: The airborne position decode, including the global mode, has multiple valid results. It is necessary to set a 'reference' lat/long on the ADSB SETUP Screen that is close to the test set's current location for the decode to work correctly.

DF17/18: Sends extended squitter for airborne position.

NOTE: ADLP (Air Data Link Processor) must be installed or transponder must have embedded ADLP, to receive data from subsystem.

NOTE: Installation must be in the airborne state to transmit airborne position.

AA (Aircraft Address) in HEX and (OCTAL)

COUNT

Indications: Displays total squitters sent since test was run, range 0 to 9999.

ME (Message Field)

Indications: Displays in 14 digit HEX format.

PERIOD (Period)
Indications: Displays DF17/18 squitter period in seconds.

LAT (Encoded Latitude)
Indications: Unambiguous Latitude decoded using Local algorithm or Compact Position Reporting (CPR) algorithm depending on Position setting.

LONG (Encoded Longitude)
Indications: Unambiguous Longitude decoded using Local algorithm or Compact Position Reporting (CPR) algorithm depending on Position setting.

POS (Position Decode)
Indications:
GLOBAL (if Global LAT/LONG not entered in ADS-B/GICB setup menu).
LOCAL (if Local LAT/LONG is entered in ADS-B/GICB setup menu).

NIC-B (Navigation Integrity Category – Supplement B) – DO-260B only, Refer to Table 17

SAF (Single Antenna Flag) – DO-260A only
Indications:
0=Dual Antenna
1=Single Antenna

T (Time Sync to UTC)
Indications:
N/UTC (not UTC),
UTC.

SURVEILLANCE STATUS
Indications:
NO INFO (No Information),
SPI (Special Position Identification),
PERM ALERT (Permanent Alert (Emergency)),
TEMP ALERT (Temporary Alert (change in Mode identity code)).

BARO PRESS ALT (Barometric Pressure Altitude)
Indications:
N/A
Displayed for types 9 to 18, range –1000 to 126700 ft.

GNSS ALTITUDE.
Indications:
N/A
Displayed for types 20 to 22, RANGE -1000 TO 126700 ft.

NIC (Navigation Integrity Category) DO-260A or DO-260B

NUC (Navigation Uncertainty Category) DO-260
Indications:
Refer to Table 17

Rc (Radius of Containment)DO-260A or DO-260B

HPL (Horizontal Protection Limit) DO-260
Indications:
Refer to Table 17

ADS-B GEN BDS 0,6

GEN BDS 0,6		AVAIL BAT 2.5 Hr	
BDS=0,6 SURFACE POS		TYPE:8	
DF17 AA:3AC421 (16542041)		COUNT=1000	
ME=000000000000		PERIOD:10.00 S	
LAT: 37 39 00 N		LONG: 97 25 48 W	
MOVMENT: 2kts		T:N/UTC	
HDG:230 deg		POS: -	
NIC= 7		Rc= <0.2nm (370.4m)	
RUN TEST		PREV TEST	NEXT TEST
		RETURN	

BDS: Indicates which BDS register is being displayed followed by its description.
0,6=Extended Squitter Surface Position.

TYPE: Identifies the ADS-B Message Type.

NOTE: Refer to ICAO Annex 10, Vol III, Part 1, Chapter 5 and RTCA-DO-260, DO-260A and DO-260B for detailed description of data fields.

NOTE: The surface position decode, including the global mode, has multiple valid results. It is necessary to set a 'reference' lat/long on the ADSB SETUP Screen that is close to the test set's current location for the decode to work correctly.

DF17/18: Sends extended squitter for surface position.

NOTE: Installation must be in the ground state to transmit surface position.

AA (Aircraft Address) in HEX and (OCTAL)

COUNT
Indications: Displays total squitters sent since test was run

ME message field displayed in 14 digit HEX format.

PERIOD
Indications: Displays DF17/18 squitter period in seconds.

LAT (Encoded Latitude)
Indications: Unambiguous Latitude decoded using Local algorithm or Compact Position Reporting (CPR) algorithm depending on Position setting.

LONG (Encoded Longitude)

Indications: Unambiguous Longitude decoded using Local algorithm or Compact Position Reporting (CPR) algorithm depending on Position setting.

MOVEMENT

Indications (DO-260A):
NO INFO (No Information Available),
STOPPED

- 0.125-<1 Kt,
- 1-<2 Kt,
- 2-<15 Kt,
- 15-<70 Kt,
- 70-<100 Kt,
- 100-<175 Kt,
- >175 Kt,

DECELERATING,
ACCELERATING,
BACKING UP

Indications (DO-260B):
Refer to Table 18

T (Time Sync to UTC)

Indications:
N/UTC (Not UTC),
UTC

HDG (Heading)

Indications: 0 to 357 Degrees or N/A if HDG Status not valid.

POS (Position Decode)

Indications:
GLOBAL (if Global LAT/LONG not entered in ADS-B/GICB setup menu).
LOCAL (if Local LAT/LONG is entered in ADS-B/GICB setup menu).

NIC (Navigation Integrity Category) DO-260A or DO-260B

NUC (Navigation Uncertainty Category) DO-260

Indications:
Refer to Table 17

Rc (Radius of Containment) DO-260A or DO-260B

HPL (Horizontal Protection Limit) DO-260

Indications:
Refer to Table 17

ADS-B GEN BDS 0,8

GEN BDS 0,8		BAT 2.5 Hr		
BDS=0,8 IDENT & CAT		TYPE: 4		
DF17 AA=3AC421		COUNT=1000		
ME=00000000000000		PERIOD: 1.00 s		
AIS= 6103B3D35C72				
FLIGHT ID: XPN34512				
EMIT CAT SET: A				
EMIT CAT: LARGE				
RUN TEST	BDS OFF	PREV PARAM	NEXT PARAM	RETURN

BDS: Indicates which BDS register is being displayed followed by its description.
0,8=Extended Squitter Identification and Category.

TYPE: Specifies class and accuracy of data. Refer to table A-2 RTCA DO-260B.

NOTE: Refer to ICAO Annex 10, Vol III, Part 1, Chapter 5 and RTCA-DO-260, DO-260A and DO-260B for detailed description of data fields.

DF17,18: Sends extended squitter for identification and category.

NOTE: ADLP (Air Data Link Processor) must be installed or transponder must have embedded ADLP, to receive data from subsystem.

AA (Aircraft Address) in HEX and (OCTAL)

COUNT

Indications: Displays total squitters sent since test was run.

ME message field displayed in 14 digit HEX format.

PERIOD

Indications: Displays DF17/18 squitter period in seconds.

EMIT CAT SET (ADS-B Emitter Category Set).

Indications: D,C,B,A.

EMIT CAT (ADS-B Emitter Category).

Indications: SMALL, MEDIUM or LARGE

EMIT CAT A:

NO ADS-B EMITTER INFO,

LIGHT,

SMALL,

LARGE,

HIGH VORTEX,

HEAVY,

HIGH PERFORMANCE,

ROTORCRAFT,

EMIT CAT B:

NO ADS-B EMITTER INFO,

GLIDER/SAILPLANE,

LIGHTER-THAN-AIR,

PARACHUTIST/SKYDIVER,

ULTRALIGHT/HANG-GLIDER,

RESERVED,

UNMANNED AERIAL VEHICLE,

SPACE VEHICLE.

EMIT CAT C:

NO ADS-B EMITTER INFO,

SURFACE EMERGENCY VEHICLE,

SURFACE SERVICE VEHICLE,

FIXED GND/TETHERED OBSTR,

CLUSTER OBSTR,

LINE OBSTR,

RESERVED,

RESERVED

EMIT CAT D:

RESERVED,

RESERVED,

RESERVED,

RESERVED,

RESERVED,

RESERVED,

RESERVED

AIS (Aircraft Identity Subfield) HEX field containing BDS plus flight ID.

FLIGHT ID Indications: 8 ICAO character field.

ADS-B GEN BDS 0,9

GEN BDS 0,9		AVAIL	BAT 2.5 Hr
BDS=0,9 AIRBORNE VEL		TYPE:19	
DF17 AA:3AC421 (16542041)	COUNT:1000		
ME=00000000000000	PERIOD:10.00 S		
E-W VEL:1000 kts E	NACV:4		
N-S VEL:1000 kts N	HDG:N/A		
SUB TYPE:1-VEL OVR GND NORM			
VERT RATE= 64 ft/min			
GEO ALT DIFF FROM BARO: -3125 ft			
SOURCE:BARO	INTENT CHANGE:YES		
AIRSPEED:N/A	AIRSPEED TYPE:N/A		
RESERVED:YES			
RUN TEST	PREV TEST	PREV TEST	RETURN

BDS: Indicates which BDS register is being displayed followed by its description.
0,9=Extended Squitter Airborne Velocity.

TYPE: Specifies class and accuracy of data. Refer to table A-2 RTCA DO-260B.

NOTE: Refer to ICAO Annex 10, Vol III, Part 1, Chapter 5 and RTCA-DO-260, DO-260A and DO-260B for detailed description of data fields.

DF17,18: Sends extended squitter for Airborne Velocity.

NOTE: ADLP (Air Data Link Processor) must be installed or transponder must have embedded ADLP, to receive data from subsystem.

NOTE: Installation must be in the airborne state to transmit airborne velocity.

AA (Aircraft Address) in HEX and (OCTAL)

COUNT

Indications: Displays total squitters sent since test was run.

ME message field displayed in 14 digit HEX format.

PERIOD

Indications: Displays DF17/18 squitter period in seconds.

SUB TYPE (Subtype Coding).

NOTE: ICAO DOC 9688 (First edition of ICAO Mode S Specific Service manual) not supported.

Indications:

0=NOT ASSIGNED
1=VEL OVR GND NORM (Velocity Over Ground Normal),
2=VEL OVER GND SUPER (Velocity Over Ground Supersonic),
3=AIR SPD NORM (Airspeed Normal),
4=AIR SPD HDG SUPER (Airspeed Supersonic),
5=NOT ASSIGNED,
6=NOT ASSIGNED,
7=NOT ASSIGNED

E-W VEL (East-West Velocity).

Indications:

N/A (Not Available),
0 to >1021 Kts (subtype 1),
0 to >4086 Kts (subtype 2),

NOTE: Followed by E (East) or W (West) direction identifier.

NACV (Navigation Accuracy Category – Velocity)

Indications:

0=Unknown or ≥ 10 m/s
1= < 10 m/s
2= < 3 m/s
3= < 1 m/s
4= < 0.3 m/s

N-S VEL (North-South Velocity)

Indications:

N/A (Not Available),
0 to >1021 Kts (subtype 1),
0 to >4086 Kts (subtype 2),

NOTE: Followed by N (North) or S (South) direction identifier.

HDG (Heading).

Indications:

N/A (Not Available),
0.0 to 359.6 Degrees.

VERT RATE (Vertical Rate).

Indications:

N/A (Not Available),
<-32608 to >32608 ft/min (subtypes 1 and 2).

GEO ALT DIFF FROM BARO (Geo Altitude Difference from Barometric Altitude).

Indications:

<-3137 ft to >3137 ft

SOURCE (Source of Vertical rate).

Indications:

N/A (Not Available),
BARO (Barometric Source),
GEO (i.e. GPS Source)

INTENT CHANGE (Intent Change Flag)

Indications:

YES
NO

AIRSPEED.

Indications:

N/A (Not Available),
0 to >1021 Kts (subtype 3)
0 to >4086 Kts (subtype 4)

AIR SPEED TYPE.

Indications:

IAS (Indicated Airspeed),
TAS (True Airspeed)

RESERVED – DO-260B only

IFR CAP ADS-B/CLASS A1 – DO-260A only

Indications:

YES
NO

ADS-B GEN BDS 0,A

GEN BDS 0,A		AVAIL BAT 2.5 Hr	
BDS=0,A TEST MSG		TYPE:23	
DF17 AA:3AC421 (16542041)		COUNT=1000	
ME=42900000000000		PERIOD:1.00 S	
SUBTYPE:7			
A CODE:4122			
RESERVED:000000000			
RUN TEST	PREV TEST	PREV TEST	RETURN

BDS: Indicates which BDS register is being displayed followed by its description.
0,A=Extended Squitter Event-Driven Register.

TYPE: Specifies class and accuracy of data. Refer to table A-2 RTCA DO-260B.

NOTE: Refer to ICAO Annex 10, Vol III, Part 1, Chapter 5 and RTCA-DO-260, DO-260A and DO-260B for detailed description of data fields.

DF17,18/19: Sends extended squitter for ADS-B Test Message.

NOTE: ADLP (Air Data Link Processor) must be installed or transponder must have embedded ADLP, to receive data from subsystem.

AA (Aircraft Address) in HEX and (OCTAL)

COUNT

Indications: Displays total squitters sent since test was run.

ME message field displayed in 14 digit HEX format.

PERIOD

Indications: Displays DF17/18/19 squitter period in seconds.

SUB TYPES (Subtype Coding).

Indications:

0 (ICAO DOC 9688 (First edition of ICAO Mode S Specific Service manual) not supported. Refer to DO-260/DO-260A, change 1.

A CODE

Decodes & displays Mode A 4096 code. Range: 0000 to 7777.

RESERVED

Decodes and displays 9 Hex character Reserved field.

ADS-B GEN BDS 6,1 ST1

GEN BDS 6,1 ST1		AVAIL BAT 2.5 Hr	
BDS=6,1 A/C STATUS ST1		TYPE:28	
DF17 AA:3AC421 (16542041)		COUNT=1000	
ME=00000000000000		PERIOD=10.00 S	
SUBTYPE:1-EMERGENCY/PRIOR STATUS			
EMERGENCY/PRIOR CODE:0-NO EMERGENCY			
MODE A (4096) CODE:0707			
RESERVED:000000000			
RUN TEST	PREV TEST	PREV TEST	RETURN

BDS: Indicates which BDS register is being displayed followed by its description.
6,1=Extended Squitter Aircraft Status.

TYPE: Specifies class and accuracy of data. Refer to table A-2 RTCA DO-260B.

NOTE: Refer to ICAO Annex 10, Vol III, Part 1, Chapter 5 and RTCA-DO-260, DO-260A and DO-260B for detailed description of data fields.

DF17,18: Sends extended squitter for Aircraft Status.

NOTE: ADLP (Air Data Link Processor) must be installed or transponder must have embedded ADLP, to receive data from subsystem.

AA (Aircraft Address) in HEX and (OCTAL)

COUNT

Indications: Displays total squitters sent since test was run.

ME message field displayed in 14 digit HEX format.

PERIOD

Indications: Displays DF17/18 squitter period in seconds.

EMERG/PRIOR CODE (Emergency/Priority Status Coding).

Indications:

0=NO EMERGENCY,
1=GENERAL EMERGENCY,
2=LIFEGUARD/MEDICAL,
3=MINIMUM FUEL,
4=NO COMM,
5=UNLAWFUL INTERFNC,
6=DOWNED AIRCRAFT,
7=RESERVED.

MODE A (4096) CODE – DO-260B only
4 digit OCTAL field.

Indications:
0000 to 7777

RESERVED subfield, 12 digit HEX field
containing contents of bits 12 to 56 for
DO-260A, 25-56 for DO-260B.

SUB TYPE (Subtype Coding).

Indications:
0=NO INFO

1=EMERGENCY/PRIOR STATUS

2=TCAS RA BROADCAST

3-7=RESERVED

ADS-B GEN BDS 6,1 ST2

GEN BDS 6,1 ST2		AVAIL	BAT 2.5 Hr
BDS=6,1 A/C STATUS		TYPE:28	
DF17 AA:3AC421 (16542041)		COUNT=1000	
ME=000000000000		PERIOD=10.00 S	
SUBTYPE:0-NO INFO			
TTI:			
TIDA:		TIDR:	
TIDB:		RAT:	
ARA:		RAC:	
MTE:			
THREAT ADDR:			
RUN TEST		PREV TEST	PREV TEST
			RETURN

BDS: Indicates which BDS register is being displayed followed by its description.
6,1=Extended Squitter Aircraft Status.

TYPE: Specifies class and accuracy of data. Refer to table A-2 RTCA DO-260B.

NOTE: Refer to ICAO Annex 10, Vol III, Part 1, Chapter 5 and RTCA-DO-260, DO-260A and DO-260B for detailed description of data fields.

DF17,18: Sends extended squitter for Aircraft Status.

NOTE: ADLP (Air Data Link Processor) must be installed or transponder must have embedded ADLP, to receive data from subsystem.

AA (Aircraft Address) in HEX and (OCTAL)

COUNT

Indications: Displays total squitters sent since test was run.

ME message field displayed in 14 digit HEX format.

PERIOD

Indications: Displays DF17/18 squitter period in seconds.

TTI (Threat Type Indicator)

Indications:

0=No identity data in TID

1=TID contains a Mode S transponder address

2=TID contains altitude, range and bearing data.

3=Not assigned

TIDA (Threat Identity Data – Altitude)

Indications:

Mode C altitude of the threat.

-1000 to 126700 ft res: 100 ft

TIDB (Threat Identity Data – Bearing)

Indications:
N/A (not available)
0 to 360 deg

RAT (RA Terminated)

Indications:
0=ACAS is currently generating the RA indicated in the ARA subfield.
1=The RA indicated by the ARA subfield has been terminated.

TIDR (Threat Identity Data – Range)

Indications:
N/A (not available)
<0.05 nm
0.10 to 12.50 nm, resolution 0.10 nm
>12.55 nm

ARA (Active Resolution Advisories)

Indications:
14 bit subfield indicating characteristics of the RA.

MTE (Multiple Threat Encounter)

Indications:
0=One threat is being processed by the resolution logic (when ARA bit 41=0)
1=Two or more simultaneous threats are being processed by the resolution logic.

RAC (RACS Record) 4 bit subfield.

Indications:
Bit 55=Do not pass below
Bit 56=Do not pass above
Bit 57=Do not turn left
Bit 58=Do not turn right
0=Inactive
1=Active

THREAT ADDR (Aircraft Address of the Threat)

Indications:
Bits 63-86.

ADS-B GEN BDS 6,2 ST0
(DO-260A / DO-260B Only)

GEN BDS 6,2 ST0				BAT 2.5 Hr	
BDS=6,2 TSS SUBTYPE 0				TYPE:29	
DF17 AA:3AC421 (16542041)				COUNT=1000	
ME=E9D2A02F041415				PERIOD: 1.00 s	
VERT DATA/SOURCE INFO:FMS/RNAV					
TARG ALT CAP:HLDG ALT-ACP-FMS/RNAV					
VERT MODE IND:ACQUIRING SIL:1					
TARG ALT TYPE:MSL NIC BARO:1					
TARG ALT: 31000 ft TARG HDG:240 deg					
TCAS/ACAS OPERATIONAL:YES RAA:NO					
HORIZ DATA AVAIL/SOURCE IND:MCP/FCU					
HORIZ MODE IND:MAINTAINING NAC:0					
EMERG/PRIOR CODE:UNLAWFUL INTERFNC					
RUN TEST	BDS OFF	PREV TEST	NEXT TEST	RETURN	

BDS: Indicates which BDS register is being displayed followed by its description.
6,2 ST0=Target State and Status Information.

TSS SUBTYPE (Target State and Status Subtype)

Indications:
0=DO-260A

TYPE: Specifies class and accuracy of data. Refer to table A-2 RTCA DO-260B.

NOTE: Refer to ICAO Annex 10, Vol III, Part 1, Chapter 5 and RTCA-DO-260, DO-260A and DO-260B for detailed description of data fields.

DF17,18: Sends extended squitter for Target State.

NOTE: ADLP (Air Data Link Processor) must be installed or transponder must have embedded ADLP, to receive data from subsystem.

NOTE Installation must be in the airborne state to transmit target state and status.

AA (Aircraft Address) in HEX and (OCTAL)

COUNT

Indications: Displays total squitters sent since test was run.

ME message field displayed in 14 digit HEX format.

PERIOD

Indications: Displays DF17/18 squitter period in seconds.

NOTE: Autopilot must be engaged and stimulated by sensor data for some fields to display data.

VERT DATA/SOURCE INFO (Vertical Data Available/Source Indicator)

Indications:

NOT VALID

MCP/FCU (Mode Control Panel/Flight Control Unit),

HLD ALT (Holding Altitude),

FMS/RNAV (FMS/RNAV System).

TARG ALT CAP (Target Altitude Capability)

Indications:

HLDG ALT (Capability for reporting Holding altitude only),

HLDG ALT-ACP (Capability for reporting either Holding altitude or Autopilot control panel selected altitude),

HLDG ALT-ACP-FMS/RNAV (Capability for reporting either Holding altitude or Autopilot control panel selected altitude, or any FMS/RNAV level off altitude).

RESERVED

VERT MODE IND (Vertical Mode Indicator)

Indications:

UNKNOWN, (Unknown Mode or Information unavailable),

ACQUIRING (Acquiring Mode),

MAINTAINING (Capturing or Maintaining Mode).

RESERVED

SIL (Surveillance Integrity Level)

Indications:

0 (Unknown),

1 (1×10^{-3}) per flight),

2 (1×10^{-5}) per flight),

3 (1×10^{-7}) per flight)

TARG ALT TYPE (Target Altitude Type)

Indications:

FL (Flight Level)

MSL (Mean Sea Level)

NIC BARO (Navigation Integrity Baro)

Indications:

0 (Gillham Not Cross Checked)

1 (Gillham Cross Checked)

TARG ALT (Target Altitude)

Indications:

-1000 ft to 100,000 ft

TARGET HDG (Target Heading Angle)

Indications:

0 to 359 degrees.

INVALID

TCAS/ACAS OPERATIONAL (TCAS/ACAS Operational)

Indications:

YES,

NO.

RAA (TCAS/ACAS Resolution Advisory Active)

Indications:

YES,

NO.

HORIZ DATA AVAL/SOURCE IND (Horizontal Data Available/Source Indicator)

Indications:

NOT VALID (No Valid Horizontal Target State Data is available),

MCP/FCU (Mode Control Panel/Flight Control Unit selected track angle),

MAINTAIN (Maintain Current Heading or Track angle),

FMS/RNAV (FMS/RNAV System)

HORIZ MODE IND (Horizontal Mode Indicator)

Indications:

UNKNOWN (Unknown Mode or Information unavailable),

ACQUIRING (Acquiring Mode),

MAINTAINING (Capturing or Maintaining Mode),

RESERVED

NAC (Navigation Accuracy Category - Position)

Indications:

0= $EPU \geq 18.52$ km (≥ 10 NM)

1= $EPU \leq 18.52$ km (10NM)

2= $EPU < 7.408$ km (4NM)

3= $EPU < 3.704$ km (2NM)

4= $EPU < 1852$ m (1NM)

5= $EPU < 926$ m (0.5NM)

6= $EPU < 555.6$ m (0.3NM)

7= $EPU < 185.2$ m (0.1NM)

8= $EPU < 92.6$ m (0.05NM)

9= $EPU < 30$ m

10= $EPU < 10$ m

11= $EPU < 3$ m

12=Reserved

13=Reserved

14=Reserved

15=Reserved

EMERG/PRIOR CODE (Emergency/Priority Status Coding).

Indications:

0=NO EMERGENCY,

1=GENERAL EMERGENCY,

2=LIFEGUARD/MEDICAL,

3=MINIMUM FUEL,

4=NO COMM,

5=UNLAWFUL INTERFNC,

6=DOWNED AIRCRAFT,

7=RESERVED.

**ADS-B GEN BDS 6,2 ST1
(DO-260A / DO-260B Only)**

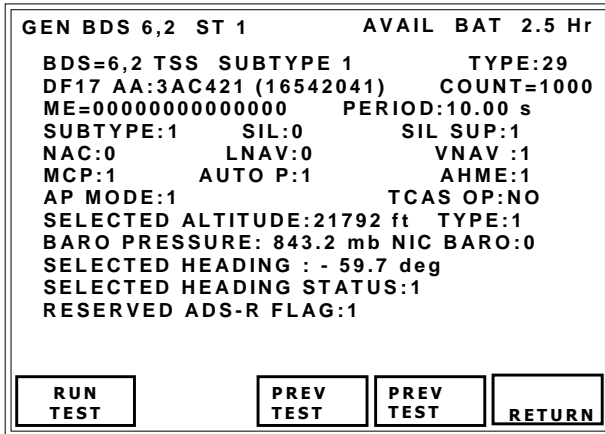

BDS: Indicates which BDS register is being displayed followed by its description.
6,2 ST1=Target State and Status Information.

TSS SUBTYPE (Target State and Status Subtype)

Indications:
1= DO-260B

TYPE: Specifies class and accuracy of data. Refer to table A-2 RTCA DO-260B.

NOTE: Refer to ICAO Annex 10, Vol III, Part 1, Chapter 5 and RTCA-DO-260, DO-260A and DO-260B for detailed description of data fields.

DF17,18: Sends extended squitter for Target State.

NOTE: ADLP (Air Data Link Processor) must be installed or transponder must have embedded ADLP, to receive data from subsystem.

NOTE Installation must be in the airborne state to transmit target state and status and status.AA (Aircraft Address) in HEX and (OCTAL).

COUNT

Indications: Displays total squitters sent since test was run.

ME message field displayed in 14 digit HEX format.

PERIOD

Indications: Displays DF17/18 squitter period in seconds.

NOTE: Autopilot must be engaged and stimulated by sensor data for some fields to display data.

SUBTYPE= 1

SIL (Source Integrity Level) Indications:

- 0 (Unknown),
- 1 (1x10⁽⁻³⁾ per flight),
- 2 (1x10⁽⁻⁵⁾ per flight),
- 3 (1x10⁽⁻⁷⁾ per flight)

SIL SUP (SIL Supplement)

Indications:
0=Probability of exceeding NIC radius of containment is based on "per hour"
1=Probability of exceeding NIC radius of containment is based on "per sample"

NAC (Navigation Accuracy Category - Position)

- Indications:
- 0=EPU ≥ 18.52 km (≥ 10NM)
 - 1=EPU ≥ 18.52 km (10NM)
 - 2=EPU < 7.408 km (4NM)
 - 3=EPU < 3.704 km (2NM)
 - 4=EPU < 1852 m (1NM)
 - 5=EPU < 926 m (0.5NM)
 - 6=EPU < 555.6 m (0.3NM)
 - 7=EPU < 185.2 m (0.1NM)
 - 8=EPU < 92.6 m (0.05NM)
 - 9=EPU < 30 m
 - 10=EPU < 10 m
 - 11=EPU < 3 m
 - 12=Reserved
 - 13=Reserved
 - 14=Reserved
 - 15=Reserved

LNAV (Lateral Navigation Engaged)

Indications:
0=LNAV Mode is NOT Active
1=LNAV Mode is Active

VNAV (Vertical Navigation Engaged)

Indications:
0=VNAV Mode is NOT Active or Unknown
1=VNAV Mode is Active

MCP (Status of MCP/FCU)

Indications:

0=No Mode Information is being provided in "ME" bits 48, 49, 50 or 52 (Message bits 80, 81, 82 or 84)

1=Mode Information is deliberately being provided in "ME" bits 48, 49, 50 or 52 (Message bits 80, 81, 82 or 84)

AUTO P (Autopilot Engaged)

Indications:

0=Autopilot is NOT Engaged or Unknown (e.g., not actively coupled and flying the aircraft)

1=Autopilot is Engaged (e.g., actively coupled and flying the aircraft)

AHME (Altitude Hold Mode)

Indications:

0=Altitude Hold Mode is NOT Active or Unknown

1=Altitude Hold Mode is Active

AP MODE (Approach Mode)

Indications:

0=Approach Mode is NOT Active or Unknown

1=Approach Mode is Active

TCAS OP (TCAS Operational)

Indications:

0=TCAS System is NOT Operational (Any time RI≠3 or 4)

1=TCAS System is Operational (RI=3 or 4)

SELECTED ALTITUDE (Selected Altitude)

Indications:

0 to 65472 ft Res 32 ft

TYPE (Selected Altitude Type)

Indications:

0=MCP/FCU

1=FMS

BARO PRESSURE (Barometric Pressure)

Indications:

800 to 1208 mb Res 0.8 mb

NIC BARO (Navigation Integrity Category – Baro)

Indications:

0=Barometric Altitude Invalid

1= Barometric Altitude Valid

SELECTED HEADING (Selected Heading)

Indications:

+/- 180 deg Res 180/256 (0.703125 deg)

SELECTED HEADING STATUS (Selected Heading Status)

Indications:

0=Invalid

1=Valid

ADS-B GEN BDS 6,5 AIR

GEN BDS 6,5 AIR		AVAIL BAT 2.5 Hr	
BDS=6,5 A/C OP STATUS AIR TYPE :31			
DF17 AA:123456 (00432126) COUNT =11			
ME=F82AAA2AAA4AAF PERIOD:1.57 s			
SUBTYPE:0-AIR		VERSION:2-DO-260B	
CC FMT:2AAA ARV:1 TS:0 1090:0			
UAT:1 TC:2		ADSR:0 TCAS OP:1	
OM FMT:0		SDA:0 SAF:0 ATC:1	
RA:1 ID:NO			
HRZ REF:MAG NORTH		NIC-A:0 GVA:2	
NIC-BARO:1		SIL SUP:1 SIL:2	
NACP:10-EPU < 0.0054		ADSR(56) :1	
RUN TEST	PREV TEST	PREV TEST	RETURN

BDS: Indicates which BDS register is being displayed followed by its description.
6,5=Aircraft Operational Status, Airborne Subtype.

TYPE: Specifies class and accuracy of data. Refer to table A-2 RTCA DO-260B.

NOTE: Refer to ICAO Annex 10, Vol III, Part 1, Chapter 5 and RTCA-DO-260, DO-260A and DO-260B for detailed description of data fields.

DF17/18: Displays which extended squitter is being received.

NOTE: Refer to RTCA/DO-260A, Appendix A, section §A.1.8, Figure A-10, replaces "BDS 6,3" with "BDS 6,5." Both BDS 6,3 and 6,5 are supported and data displayed is identical.

COUNT

Indications: Displays total squitters sent since test was run.

ME message field displayed in 14 digit HEX format.

PERIOD

Indications: Displays DF17/18 squitter period in seconds.

NOTE: ADLP (Air Data Link Processor) must be installed or transponder must have embedded ADLP, to receive data from subsystem.

SUBTYPE

Indications:

- 0=AIR (Airborne Status message),
- 1=SUR (Surface Status message),
- 2=RESERVED,
- 3=RESERVED,
- 4=RESERVED,
- 5=RESERVED,
- 6=RESERVED,
- 7=RESERVED,

VERSION (MOPS Version Number)

Indications:

- 0-DO-260
- 1-DO-260A
- 2-DO-260B

CC FMT (Capability Class)

ME BITS 9-24 (airborne)

ME BITS 9-20 (surface)

0000-FFFF (airborne)

000-FFF (surface)

ARV (Air Referenced Velocity Report Capability) Only Available when Subtype= Airborne.

Indications:

N/A (Surface)

1 (Capability of sending messages to support Air-Referenced velocity reports),

0 (No Capability of sending messages to support Air-Referenced velocity reports)

TS (Target State Report Capability) Only Available when Subtype= Airborne

Indications:

N/A (Surface)

1 (Capability of sending messages to support Target State Reports),

0 (No Capability of sending messages to support Target State Reports)

CDTI – DO-260A

1090 (1090 In Capability) – DO-260B

0=Not Capable

1=Capable

Aircraft has ADS-B 1090ES Receive

UAT (UAT In Capability)

Indications:

0=(No Capability to receive ADS-B UAT messages)

1=(Aircraft has capability to receive ADS-B UAT messages)

TC (Target Change Report Capability) Only Available when Subtype= Airborne.

Indications:

N/A (Surface)

0 (No capability for sending messages to support trajectory change reports) ,

1 (Capability of sending messages to support TC+0 report only),

2 (Capability of sending information for multiple TC reports).

3 (Reserved)

ADSR (Reserved for ADS-R flag)

Bit 20 of the ME field.

Included in Class Capabilities.

Indications:

0=Not Active

1=Active

Not TCAS – DO-260A

TCAS OP (TCAS Operational) – DO-260B

Indications:

0=(TCAS/ACAS Not Operational)

1=(TCAS/ACAS Operational)

OM FMT (Operational Mode Subfield)

Indications:

0 (TCAS RA Active, IDENT Switch Active, Receiving ATC Services)

1 (Reserved)

2 (Reserved)

3 (Reserved)

SDA (System Design Assurance Data)

Indications:

0=Unknown or No Safety Effect

1=Minor

2=Major

3=Hazardous

SAF (Single Antenna Flag)

Indications:

0=Dual Antenna

1=Single Antenna

ATC (Receiving ATC Services)

Indications:

1 (Aircraft receiving ATC services),

0 (Aircraft not receiving ATC services).

RA (TCAS RA Active)

Indications:

0=(TCAS II or ACAS resolution advisory inactive)

1=(TCAS II or ACAS resolution advisory active)

ID (Ident Switch)

Indications:

YES (Ident active),

NO (Ident not active).

HRZ REF (Horizontal Reference Direction)

Indications:

TRUE NORTH

MAG NORTH (Magnetic North)

NIC-A (Navigation Integrity Category – Supplement A)

Indications:

DO-260A only

0 (Rc unknown)

1 (Rc < 20 NM)

DO-260B only, Refer to Table 17

BAQ (Barometric Altitude Quality) DO-260A
GVA (Geometric Vertical Accuracy) DO-260B

Indications:

0=Unknown or >150 m

1= ≤ 150 m

2= ≤ 45 m

3=Reserved

NIC BARO (Navigation Integrity Baro)

Indications:

N/A (Surface)

0 (Gillham Not Cross Checked)

1 (Gillham Cross Checked)

SIL SUP (SIL Supplement) DO-260B only

Indications:

0=Probability of exceeding NIC radius of containment is based on "per hour"

1=Probability of exceeding NIC radius of containment is based on "per sample"

SIL (Surveillance Integrity Level)

Indications:

0 (Unknown),

1 (1×10^{-3} per flight),

2 (1×10^{-5} per flight),

3 (1×10^{-7} per flight)

NACP

Indications:

0=EPU>18.52 km (>10NM)

1=EPU<18.52 km (10NM)

2=EPU<7.408 km (4NM)

3=EPU<3.704 km (2NM)

4=EPU<1852 m (1NM)

5=EPU<926 m (0.5NM)

6=EPU<555.6 m (0.3NM)

7=EPU<185.2 m (0.1NM)

8=EPU<92.6 m (0.05NM)

9=EPU<30 m (0.016NM)

10=EPU<10 m (0.0054NM)

11=EPU<3 m (0.0016NM)

12=Reserved

13=Reserved

14=Reserved

15=Reserved

ADSR(56) (Reserved for ADS-R flag)

Bit 56 of the ME field.

Indications:

0=Not Active

1=Active

ADS-B GEN BDS 6,5 SUR

GEN BDS 6,5	SUR	AVAIL BAT 2.5 Hr	
BDS=6,5 A/C OP STATUS SUR TYPE :31			
DF17 AA:123456 (04432126) COUNT =9			
ME=0F92AAA2AAA4AAF PERIOD:1.64 s			
SUBTYPE:1-SUR VERSION:2-DO-260B			
CC FMT :2AA B2 LOW:1 1090:0			
UAT:0 NIC-C:0 NACV:5			
OM FMT:0 SDA:0 SAF:2 ATC:1			
RA:1 ID:NO ANT OFF:RT 2 M,20 M			
HRZ REF:MAG NORTH NIC-A:0 POA:N/A			
TRK/HDG:NTRK SIL SUP:1 SIL:2			
NACP:10-EPU < 0.0054 ADSR(56) :1			
LN/WD:10-<65M, <59.5M			
RUN TEST	PREV TEST	PREV TEST	RETURN

BDS: Indicates which BDS register is being displayed followed by its description.

6,5=Aircraft Operational Status, Surface Subtype.

TYPE: Specifies class and accuracy of data. Refer to table A-2 RTCA DO-260B.

NOTE: Refer to ICAO Annex 10, Vol III, Part 1, Chapter 5 and RTCA-DO-260, DO-260A and DO-260B for detailed description of data fields.

DF17/18: Displays which extended squitter is being received.

NOTE: Refer to RTCA/DO-260A, Appendix A, section §A.1.8, Figure A-10, replaces "BDS 6,3" with "BDS 6,5." Both BDS 6,3 and 6,5 are supported and data displayed is identical.

COUNT

Indications: Displays total squitters sent since test was run.

ME message field displayed in 14 digit HEX format.

PERIOD

Indications: Displays DF17/18 squitter period in seconds.

NOTE: ADLP (Air Data Link Processor) must be installed or transponder must have embedded ADLP, to receive data from subsystem.

SUBTYPE

Indications:

0=AIR (Airborne Status message),
1=SUR (Surface Status message),
2=RESERVED,
3=RESERVED,
4=RESERVED,
5=RESERVED,
6=RESERVED,
7=RESERVED,

VERSION (MOPS Version Number)

Indications:

0-DO-260
1-DO-260A
2-DO-260B

CC FMT (Capability Class)

ME BITS 9-24 (airborne)
ME BITS 9-20 (surface)
0000-FFFF (airborne)
000-FFF (surface)

B2 LOW

Indications:

N/A (Airborne)
0 (≥ 70 W)
1 (< 70 W)

CDTI – DO-260A

1090 (1090 In Capability) – DO-260B

0=Not Capable

1=Capable

Aircraft has ADS-B 1090ES Receive

UAT (UAT In Capability)

Indications:

0=(No Capability to receive ADS-B UAT messages)
1=(Aircraft has capability to receive ADS-B UAT messages)

NIC-C (Navigation Integrity Category – Supplement C)

Indications: Refer to Table 17

NACV (Navigation Accuracy Category – Velocity)

Indications:

0=Unknown or ≥ 10 m/s
1= < 10 m/s
2= < 3 m/s
3= < 1 m/s
4= < 0.3 m/s

OM FMT (Operational Mode Subfield)

Indications:

0 (TCAS RA Active, IDENT Switch Active, Receiving ATC Services)
1 (Reserved)
2 (Reserved)
3 (Reserved)

SDA (System Design Assurance Data)

Indications:

0=Unknown or No Safety Effect
1=Minor
2=Major
3=Hazardous

SAF (Single Antenna Flag)

Indications:

0=Dual Antenna
1=Single Antenna

ATC (Receiving ATC Services)

Indications:

1 (Aircraft receiving ATC services),
0 (Aircraft not receiving ATC services).

RA (TCAS RA Active)

Indications:

0=(TCAS II or ACAS resolution advisory inactive)
1=(TCAS II or ACAS resolution advisory active)

ID (Ident Switch)

Indications:

YES (Ident active),
NO (Ident not active).

ANT OFF (GPS Antenna Offset Data)

Refer to Tables 19 and 20.

HRZ REF (Horizontal Reference Direction)

Indications:

TRUE NORTH
MAG NORTH (Magnetic North)

NIC-A (Navigation Integrity Category – Supplement A)

Indications:

DO-260A only
0 (Rc unknown)
1 (Rc < 20 NM)
DO-260B only, Refer to Table 17

POA (Position Offset Applied) DO-260A only

Indications:

N/A (Airborne)
0 (Position transmitted is not the ADS-B position reference point)
1 (Position transmitted is the ADS-B position reference point)

TRK/HDG (Used for surface ADS-B participants, surface position message heading or ground track determination bit)

Indications:

N/A (Airborne)
0 (Target Heading Reported)
1 (Track Angle Reported)

SIL SUP (SIL Supplement) DO-260B only

Indications:

0=Probability of exceeding NIC radius of containment is based on "per hour"

1=Probability of exceeding NIC radius of containment is based on "per sample"

SIL (Surveillance Integrity Level)

Indications:

0 (Unknown),

1 (1x10⁻³ per flight),

2 (1x10⁻⁵ per flight),

3 (1x10⁻⁷ per flight)

NACP

Indications:

0=EPU>18.52 km (>10NM)

1=EPU<18.52 km (10NM)

2=EPU<7.408 km (4NM)

3=EPU<3.704 km (2NM)

4=EPU<1852 m (1NM)

5=EPU<926 m (0.5NM)

6=EPU<555.6 m (0.3NM)

7=EPU<185.2 m (0.1NM)

8=EPU<92.6 m (0.05NM)

9=EPU<30 m (0.016NM)

10=EPU<10 m (0.0054NM)

11=EPU<3 m (0.0016NM)

12=Reserved

13=Reserved

14=Reserved

15=Reserved

ADSR(56) (Reserved for ADS-R flag)

Bit 56 of the ME field.

Indications:

0=Not Active

1=Active

LN/WD (Aircraft Length and Width)

Aircraft or Vehicle Length

Indications: Length,Width

0=No Data or Unknown

1=<15m, <23m

2=<25m, <28.5m

3=<25m, <34m

4=<35m, <33m

5=<35m, <38m

6=<45m, <39.5m

7=<45m, <45m

8=<55m, <45m

9=<55m, <52m

10=<65m, <59.5m

11=<65m, <67m

12=<75m, <72m

13=<75m, <80m

14=<85m, <80m

4.5.7 GICB GENERAL

GICB (Ground Initiated Comm B) is a protocol used by Mode S ground stations to extract DAP's (Downlinked Aircraft Parameters) from Mode S transponder equipped aircraft. DAP's are utilized by Air Traffic Control equipment, to provide the air traffic controller with accurate and predictive tracks i.e. anticipated altitude changes. DAP'S are obtained from various sub-systems via a separate or transponder integral ADLP (Air Data Link Processor). DAP's are stored in the transponder BDS (B-Definition Subfield) registers. There are 255 BDS registers, not all defined at this time.

4.5.8 GICB MODE

GICB mode of operation uses UF4 or UF5 interrogations with reply length set to long, to request DF20 or DF21 replies with MB message field containing transponder BDS register contents, which are decoded and displayed.

GICB DF20	AVAIL	BAT	2.5 Hr
1 0,5 AIRBORNE POS	-	AVAIL	
2 0,6 SURFACE POS	-	NOT CAP	
3 0,7 SQTR STATUS	-	AVAIL	
4 0,8 IDENT & CAT	-	AVAIL	
5 0,9 AIRBORNE VEL	-	AVAIL	
6 1,0 DATA LNK CAP	-	AVAIL	
7 1,7 COM GICB CAP	-	AVAIL	
8 1,8 SPEC SERV CAP #1	-	AVAIL	
9 1,9 SPEC SERV CAP #2	-	AVAIL	
10 1,A SPEC SERV CAP #3	-	AVAIL	
11 1,B SPEC SERV CAP #4	-	AVAIL	
12 1,C SPEC SERV CAP #5	-	AVAIL	

RUN TEST BDS DATA NEXT PAGE RETURN

GICB DF20	AVAIL	BAT	2.5 Hr
13 1,D MSP CAP RPT 1-28	-	AVAIL	
14 1,E MSP CAP RPT 29-56	-	AVAIL	
15 1,F MSP CAP RPT 57-63	-	AVAIL	
16 2,0 FLIGHT IDAT	-	AVAIL	
17 2,1 AIRCRAFT REG	-	AVAIL	
18 3,0 ACAS ARA	-	AVAIL	
19 4,0 VERT INTENT	-	AVAIL	
20 4,1 WAYPOINT NAME	-	AVAIL	
21 4,2 WAYPOINT POS	-	AVAIL	
22 4,3 WAYPOINT DETAILS	-	AVAIL	
23 5,0 TRACK & TURN	-	NOT RUN	
24 6,0 HEADING & SPEED	-	NOT RUN	

RUN TEST BDS DATA PREV PAGE NEXT PAGE RETURN

GICB DF20		AVAIL	BAT	2.5 Hr
17	2,1	AIRCRAFT REG #	-	AVAIL
18	3,0	ACAS ARA	-	AVAIL
19	4,0	VERT INTENT	-	AVAIL
20	4,1	WAYPOINT NAME	-	AVAIL
21	4,2	WAYPOINT NAME	-	AVAIL
22	4,3	WAYPOINT NAME	-	AVAIL
23	5,0	TRACK & TURN	-	AVAIL
24	6,0	HEADING & SPEED	-	AVAIL
25	6,1	A/C STATUS ST1	-	AVAIL
26	6,1	A/C STATUS ST2	-	AVAIL
27	6,2	TSS SUBTYPE 0	-	AVAIL
28	6,2	TSS SUBTYPE 1	-	NOT RUN
29	6,5	A/C OP STATUS AIR	-	AVAIL
30	6,5	A/C OP STATUS SUR	-	AVAIL

RUN TEST	BDS DATA	PREV PAGE	RETURN
----------	----------	-----------	--------

The GICB screen displays the supported BDS registers (determined by test set software version), identified by BDS register number and an abbreviated name. The Status of the received BDS is displayed to the right of the BDS name. Indications are NOT RUN (Test has not retrieved this BDS yet), AVAIL (BDS is available), NO DATA (BDS available but not reporting data), NOT CAP (transponder has identified that this BDS is not supported by transponder/subsystem).

BDS registers supported by software version 1.1.2 and above, are listed in 1-2-4 Table 21.

BDS	DESCRIPTION
0,5	Ext Squitter Airborne Position
0,6	Ext Squitter Surface Position
0,7	Ext Squitter Status
0,8	Ext Squitter Type and Identification
0,9	Ext Squitter Airborne Velocity Information
1,0	Data Link Capability Report
1,7	Common Usage GICB Capability Report
1,8	Mode S Specific Services #1
1,9	Mode S Specific Services #2
1,A	Mode S Specific Services #3
1,B	Mode S Specific Services #4
1,C	Mode S Specific Services #5
1,D	Mode S Specific Service Capability Report 1-28
1,E	Mode S Specific Service Capability Report 29-56
1,F	Mode S Specific Service Capability Report 57-63
2,0	Aircraft Identification (Flight ID)
2,1	Aircraft Registration Number
3,0	ACAS Resolution Advisory
4,0	Aircraft Vertical Intention
4,1	Waypoint Name
4,2	Waypoint Position
4,3	Waypoint Details
5,0	Track and Turn Report
6,0	Heading and Speed Report
6,1	Aircraft Status ST1
6,1	Aircraft Status ST2
6,2	Target State and Status Subtype 0
6,2	Target State and Status Subtype 1
6,5	A/C Operational Status AIR
6,5	A/C Operational Status SUR

GICB Supported BDS Registers
Table 21

TEST SCREEN DESCRIPTIONS

GICB BDS 0,5

GICB BDS 0,5		AVAIL BAT 2.5 Hr	
BDS=0,5 AIRBORNE POS		TYPE=14	
DF20 AA=3AC421 (16542041)			
MB=00000000000000			
LAT= 37 39 0 N		LONG= 97 25 48 W	
POS=GLOBAL		NIC-B=1	T=N/UTC
SURVEILLANCE STATUS = NO INFO			
BARO PRES ALT=126700 ft			
GNSS ALT = N/A			
NIC= 5		Rc= <1 nm (1852 m)	
RUN TEST	PREV TEST	NEXT TEST	RETURN

Uses UF20/21 BDS 0,7 register request:
 Receives DF20/21 reply and decodes MB message field containing BDS register contents and displays Squitter Status.

TYPE: Identifies the GICB Message Type.

DF20/21: Receives DF20/21 reply, decodes and displays airborne position

NOTE: ADLP (Air Data Link Processor) must be installed or transponder must have embedded ADLP, to receive data from subsystem.

NOTE: Installation must be in the airborne state to transmit airborne position.

AA (Aircraft Address) in HEX and (OCTAL)
 MB message field displayed in 14 digit HEX format.

LAT (Encoded Latitude)

Indications: Unambiguous Latitude decoded using Local algorithm or Compact Position Reporting (CPR) algorithm depending on Position setting.

LONG (Encoded Longitude)

Indications: Unambiguous Longitude decoded using Local algorithm or Compact Position Reporting (CPR) algorithm depending on Position setting.

POS (Position Decode)

Indications:

GLOBAL (if Global LAT/LONG not entered in ADS-B/GICB setup menu).

LOCAL (if Local LAT/LONG is entered in ADS-B/GICB setup menu).

NIC-B (Navigation Integrity Category – Supplement B) – 260B only, Refer to Table 17

SAF – DO-260A only

Indications:

0=Dual Antenna

1=Single Antenna

T (Time Sync to UTC)

Indications:

N/UTC (not UTC),

UTC.

SURVEILLANCE STATUS

Indications:

NO INFO (No Information),

SPI (Special Position Identification),

PERM ALERT (Permanent Alert

(Emergency)),

TEMP ALERT (Temporary Alert (change in Mode identity code)).

BARO PRESS ALT (Barometric Pressure Altitude)

Indications:

N/A

Displayed for types 9 to 18, range –1000 to 126700 ft.

GNSS ALTITUDE.

Indications:

N/A

Displayed for types 20 to 22, RANGE -1000 TO 126700 ft.

NIC (Navigation Integrity Category) DO-260A or DO-260B

NUC (Navigation Uncertainty Category) DO-260

Indications:

Refer to Table 17

Rc (Radius of Containment)DO-260A or DO-260B

HPL (Horizontal Protection Limit) DO-260

Indications:

Refer to Table 17

GICB BDS 0,6

GICB BDS 0,6		AVAIL	BAT 2.5 Hr
BDS=0,6 SURFACE POS		TYPE=8	
DF20 AA=3AC421 (16542041)			
MB=000000000000			
LAT= 37 39 00 N		LONG= 97 25 48 W	
MOVMENT= 2kts		T=N/UTC	
HDG=230 deg		POS=GLOBAL	
NIC= 7		Rc= <0.2nm (370.4m)	
RUN TEST	PREV TEST	NEXT TEST	RETURN

Uses UF20/21 BDS 0,7 register request:
 Receives DF20/21 reply and decodes MB message field containing BDS register contents and displays Squitter Status.

TYPE: Identifies the GICB Message Type.

DF20/21: Receives DF20/21 reply, decodes and displays surface position.

NOTE: Installation must be in the ground state to transmit surface position.

NOTE: The surface position decode, including the global mode, has multiple valid results. It is necessary to set a 'reference' lat/long on the ADSB SETUP Screen that is close to the test set's current location for the decode to work correctly.

AA (Aircraft Address) in HEX and (OCTAL)

MB message field displayed in 14 digit HEX format.

LAT (Encoded Latitude)

Indications: Unambiguous Latitude decoded using Local algorithm or Compact Position Reporting (CPR) algorithm depending on Position setting.

LONG (Encoded Longitude)

Indications: Unambiguous Longitude decoded using Local algorithm or Compact Position Reporting (CPR) algorithm depending on Position setting.

MOVEMENT

Indications (DO-260A):
 NO INFO (No Information Available),
 STOPPED

0.125-<1 Kt,
 1-<2 Kt,
 2-<15 Kt,
 15-<70 Kt,
 70-<100 Kt,
 100-<175 Kt,
 >175 Kt,

DECELERATING,
 ACCELERATING,
 BACKING UP

Indications (DO-260B):

Refer to Table 18
 T (Time Sync to UTC)
 Indications:
 N/UTC (Not UTC),
 UTC

HDG (Heading)

Indications: 0 to 357 Degrees or N/A if HDG Status not valid.

POS (Position Decode)

Indications:
 GLOBAL (if Global LAT/LONG not entered in ADS-B/GICB setup menu).

LOCAL (if Local LAT/LONG is entered in ADS-B/GICB setup menu).

NIC (Navigation Integrity Category) DO-260A or DO-260B

NUC (Navigation Uncertainty Category) DO-260

Indications:
 Refer to Table 17

Rc (Radius of Containment) DO-260A or DO-260B

HPL (Horizontal Protection Limit) DO-260

Indications:
 Refer to Table 17

GICB BDS 0,7

GICB BDS 0,7		AVAIL	BAT 2.5 Hr
BDS=0,7 SQTR STATUS			
DF20 AA=3AC421 (16542041)			
MB=00000000000000			
SURFACE SQTR TRANS RATE=HIGH			
ALT TYPE=BARO			
ESS=000000000000000			
<input type="button" value="RUN TEST"/>		<input type="button" value="PREV TEST"/>	<input type="button" value="NEXT TEST"/>
<input type="button" value="RETURN"/>			

Uses UF20/21 BDS 0,7 register request: Receives DF20/21 reply and decodes MB message field containing BDS register contents and displays Squitter Status.

NOTE: ADLP (Air Data Link Processor) must be installed or transponder must have embedded ADLP to receive data from subsystem.

AA (Aircraft Address) in HEX and (OCTAL)
 MB message field displayed in 14 digit HEX format.

SURF SQTR TRAN RATE
 Indications:
 NOT CAP (No Capability to determine surface squitter rate),
 HIGH (High surface squitter rate selected),
 LOW (Low surface squitter rate selected).

ALT TYPE
 Indications:
 BARO,
 GNSS

ESS (Extended Squitter Status)
 Indications:
 14 digit hex field, bits 1 to 56

NOTE: Refer to ICAO manual on Mode S specific services DOC 9688-AN/952 and RTCA DO-260A V2 for detailed description of data fields.

GICB BDS 0,8

GICB BDS 0,8		AVAIL	BAT 2.5 Hr
BDS=0,8 IDENT & CAT		TYPE=4	
DF20 AA=3AC421 (16542041)			
MB=00000000000000			
AIS= 6103B3D35672			
FLIGHT ID =XPN34512			
EMIT CAT SET=A			
EMIT CAT=LARGE			
<input type="button" value="RUN TEST"/>		<input type="button" value="PREV TEST"/>	<input type="button" value="NEXT TEST"/>
<input type="button" value="RETURN"/>			

Uses UF20/21 BDS 0,7 register request: Receives DF20/21 reply and decodes MB message field containing BDS register contents and displays Squitter Status.

TYPE: Identifies the GICB Message Type.

DF20/21: Receives DF20/21 reply, decodes and displays identification and category.

NOTE: ADLP (Air Data Link Processor) must be installed or transponder must have embedded ADLP, to receive data from subsystem.

AA (Aircraft Address) in HEX and (OCTAL)
 MB message field displayed in 14 digit HEX format.

EMIT CAT SET (ADS-B Emitter Category Set).

Indications: D,C,B,A.

EMIT CAT (ADS-B Emitter Category).

Indications: SMALL, MEDIUM or LARGE

EMIT CAT A:

NO ADS-B EMITTER INFO,
 LIGHT,
 SMALL,
 LARGE,
 HIGH VORTEX,
 HEAVY,
 HIGH PERFORMANCE,
 ROTORCRAFT,

EMIT CAT B:

NO ADS-B EMITTER INFO,
GLIDER/SAILPLANE,
LIGHTER-THAN-AIR,
PARACHUTIST/SKYDIVER,
ULTRALIGHT/HANG-GLIDER,
RESERVED,
UNMANNED AERIAL VEHICLE,
SPACE VEHICLE.EMIT CAT C:
NO ADS-B EMITTER INFO,
SURFACE EMERGENCY VEHICLE,
SURFACE SERVICE VEHICLE,
FIXED GND/TETHERED OBSTR,
CLUSTER OBSTR,
LINE OBSTR,
RESERVED,
RESERVED

EMIT CAT D:

RESERVED,
RESERVED,
RESERVED,
RESERVED,
RESERVED,
RESERVED,
RESERVED

AIS (Aircraft Identity Subfield) HEX field
containing BDS plus flight ID.

FLIGHT ID Indications: 8 ICAO character
field.

GICB BDS 0,9

GICB BDS 0,9	AVAIL	BAT 2.5 Hr
BDS=0,9	AIRBORNE VEL	TYPE=19
DF20 AA=3AC421	(16542041)	
MB=00000000000000		
E-W VEL=1000 kts E	NACV=4	
N-S VEL=1000 kts N	HDG=N/A	
SUB TYPE=VEL OVR GND NORM		
VERT RATE= +12 ft/min		
GEO ALT DIFF FROM BARO=	-3125 ft	
SOURCE=BARO	INTENT CHANGE=YES	
AIRSPEED=N/A	AIRSPEED TYPE=N/A	
	RESERVED=YES	

RUN TEST	PREV TEST	PREV TEST	RETURN
----------	-----------	-----------	--------

Uses UF20/21 BDS 0,7 register request:
Receives DF20/21 reply and decodes MB
message field containing BDS register
contents and displays Squitter Status.

TYPE: Identifies the GICB Message Type.

DF20/21: Receives DF20/21 reply, decodes
and displays Airborne Velocity.

NOTE: ADLP (Air Data Link Processor) must
be installed or transponder must
have embedded ADLP, to receive
data from subsystem.

NOTE Installation must be in the airborne
state to transmit target state and
status.

AA (Aircraft Address) in HEX and (OCTAL)
MB message field displayed in 14 digit HEX
format.

SUB TYPE (Subtype Coding).

NOTE: ICAO DOC 9688 (First edition of
ICAO Mode S Specific Service
manual) not supported.

Indications:

- 0=NOT ASSIGNED
- 1=VEL OVR GND NORM (Velocity Over
Ground Normal),
- 2=VEL OVER GND SUPER (Velocity Over
Ground Supersonic),
- 3=AIR SPD NORM (Airspeed Normal),
- 4=AIR SPD HDG SUPER (Airspeed
Supersonic),
- 5=NOT ASSIGNED,
- 6=NOT ASSIGNED,
- 7=NOT ASSIGNED

E-W VEL (East-West Velocity).

Indications:

- N/A (Not Available),
- 0 to >1021 Kts (subtype 1),
- 0 to >4086 Kts (subtype 2),

NOTE: Followed E (East) or W (West) direction identifier.

NACV (Navigation Accuracy Category – Velocity)

Indications:

0=Unknown or ≥ 10 m/s

1= < 10 m/s

2= < 3 m/s

3= < 1 m/s

4= < 0.3 m/s

N-S VEL (North-South Velocity)

Indications:

N/A (Not Available),

0 to > 1021 Kts (subtype 1),

0 to > 4086 Kts (subtype 2),

NOTE: Followed by N (North) or S (South) direction identifier.

HDG (Heading).

Indications:

N/A (Not Available),

0.0 to 359.6 Degrees.

INTENT CHANGE (Intent Change Flag)

Indications:

Yes,

No

VERT RATE (Vertical Rate).

Indications:

N/A (Not Available),

< -32608 to > 32608 ft/min (subtypes 1 and 2).

GEO ALT DIFF FROM BARO (Geo Altitude Difference from Barometric Altitude).

Indications:

< -3137 to ft > 3137 ft

SOURCE (Source of Vertical rate).

Indications:

N/A (Not Available),

BARO (Barometric Source),

GEO (i.e. GPS Source)

AIRSPEED.

Indications:

N/A (Not Available),

0 to > 1021 Kts (subtype 3)

0 to > 4086 Kts (subtype 4)

AIR SPEED TYPE.

Indications:

IAS (Indicated Airspeed),

TAS (True Airspeed)

RESERVED – DO-260B only

IFR CAP ADS-B/CLASS A1 – DO-260A only

Indications:

YES

NO

GICB BDS 1,0

GICB BDS 1,0		AVAIL BAT 2.5 Hr	
BDS=1,0 DATA LINK CAP			
DF20 AA=3AC421 (16542041)			
MB=00000000000000			
SUBNET VER NBR=1		SI CAP=YES	
AIRCRAFT ID CAP=YES		XPDR LEVEL=2-4	
CONT FLAG=YES		SQUITTER CAP=YES	
SPEC SERV CAP REP=YES		DTE=YES	
UELM SEG CAP=16/250 ms			
DELM SEG CAP=16/250 ms			
COMM USE GICB REP=0			
RUN TEST		PREV TEST	
PREV TEST		RETURN	

Uses UF4/5 Reply Length Long, BDS 1,0 register request: Receives DF20/21 reply and decodes MB message field containing BDS register contents and displays Data Link Capability Report.

AA (Aircraft Address) in HEX and (OCTAL)

MB message field displayed in 14 digit HEX format.

NOTE: ADLP (Air Data Link Processor) must be installed or transponder must have embedded ADLP to receive data from subsystem.

SUBNET VER NBR

Indications:

0-127

SI CAP

Indications:

YES (surveillance identifier code capability)

NO (no surveillance identifier code capability)

CONT FLAG

Indications:

YES (a continuation report may be found in registers BDS 1,1 up to BDS 1,6 which are not implemented in this revision)

NO

GICB BDS 1,7

GICB BDS 1,7		AVAIL		BAT 2.5 Hr	
BDS=1,7 COM GICB CAP					
DF20 AA=3AC421 (16542041)					
MB=FFFFFFFF00000000					
:0,5	:0,6	:0,7	:0,8	:0,9	:0,A
:2,0	:2,1	:4,0	:4,1	:4,2	:4,3
:4,4	:4,5	:4,8	:5,0	:5,1	:5,2
:5,3	:5,4	:5,5	:5,6	:5,F	:6,0
RUN TEST		PREV TEST		PREV TEST	
				RETURN	

Uses UF4/5 Reply Length Long, BDS 1,7 register request: Receives DF20/21 reply and decodes MB message field containing BDS register contents and displays Common GICB Capability Report.

AA (Aircraft Address) in HEX and (OCTAL)

MB message field displayed in 14 digit HEX format.

Refer to 1-2-4, Table 17. Each BDS register supported by the transponder is displayed.

NOTE: ADLP (Air Data Link Processor) must be installed or transponder must have embedded ADLP to receive data from subsystem.

NOTE: Refer to ICAO manual on Mode S specific services DOC 9688-AN/952 and RTCA DO-260A V2 for detailed description of data fields

GICB BDS 1,8 – 1,C

GICB BDS 1,8		AVAIL		BAT 2.5 Hr	
BDS=1,8 SPECIFIC SERV #1					
DF20 AA=3AC421 (16542041)					
MB=FFFFFFFFFFFFFFF					
:0,1	:0,2	:0,3	:0,4	:0,5	:0,6
:0,8	:0,9	:0,A	:0,B	:0,C	:0,E
:0,F	:1,0	:1,1	:1,2	:1,3	:1,4
:1,6	:1,7	:1,8	:1,9	:1,A	:1,B
:1,D	:1,E	:1,F	:2,0	:2,1	:2,2
:2,4	:2,5	:2,6	:2,7	:2,8	:2,9
:2,B	:2,C	:2,D	:2,E	:2,F	:3,0
:3,2	:3,3	:3,4	:3,5	:3,6	:3,7
RUN TEST		PREV TEST		PREV TEST	
				RETURN	

GICB BDS 1,9		AVAIL		BAT 2.5 Hr	
BDS=1,9 SPECIFIC SERV #2					
DF20 AA=3AC421 (16542041)					
MB=FFFFFFFFFFFFFFF					
:3,9	:3,A	:3,B	:3,C	:3,D	:3,E
:4,0	:4,1	:4,2	:4,3	:4,4	:4,5
:4,7	:4,8	:4,9	:4,A	:4,B	:4,C
:4,E	:4,F	:5,0	:5,1	:5,2	:5,3
:5,5	:5,6	:5,7	:5,8	:5,9	:5,A
:5,C	:5,D	:5,E	:5,F	:6,0	:6,1
:6,3	:6,4	:6,5	:6,6	:6,7	:6,8
:6,A	:6,B	:6,C	:6,D	:6,E	:7,0
RUN TEST		PREV TEST		PREV TEST	
				RETURN	

GICB BDS 1,A		AVAIL		BAT 2.5 Hr	
BDS=1,A SPECIFIC SERV #3					
DF20 AA=3AC421 (16542041)					
MB=FFFFFFFFFFFFFFF					
:7,1	:7,2	:7,3	:7,4	:7,5	:7,6
:7,8	:7,9	:7,A	:7,B	:7,C	:7,D
:7,F	:8,0	:8,1	:8,2	:8,3	:8,4
:8,6	:8,7	:8,8	:8,9	:8,A	:8,B
:8,D	:8,E	:8,F	:9,0	:9,1	:9,2
:9,4	:9,5	:9,6	:9,7	:9,8	:9,9
:9,B	:9,C	:9,D	:9,E	:9,F	:A,0
:A,2	:A,3	:A,4	:A,5	:A,6	:A,7
RUN TEST		PREV TEST		PREV TEST	
				RETURN	

GICB BDS 1,8 – 1,C

GICB BDS 1,B		AVAIL	BAT	2.5 Hr		
BDS=1,B SPECIFIC SERV #4						
DF20 AA=3AC421 (16542041)						
MB=FFFFFFFFFFFFFF						
:A,9	:A,A	:A,B	:A,C	:A,D	:A,E	:A,F
:B,0	:B,1	:B,2	:B,3	:B,4	:B,5	:B,6
:B,7	:B,8	:B,9	:B,A	:B,B	:B,C	:B,D
:B,E	:B,F	:C,0	:C,1	:C,2	:C,3	:C,4
:C,5	:C,6	:C,7	:C,8	:C,9	:C,A	:C,B
:C,C	:C,D	:C,E	:C,F	:D,0	:D,1	:D,2
:D,3	:D,4	:D,5	:D,6	:D,7	:D,8	:D,9
:D,A	:D,B	:D,C	:D,D	:D,E	:D,F	:E,0
RUN TEST		PREV TEST	PREV TEST	RETURN		

GICB BDS 1,D – 1,F

GICB BDS 1,D		AVAIL	BAT	2.5 Hr						
BDS=1,D MSP CAP RPT 1-28										
DF20 AA=3AC421 (16542041)										
MB=FFFFFFFFFFFFFF										
UPLINK										
1	2	3	4	5	6	7	8	10	11	12
13	14	15	16	17	18	19	20	21	22	23
25	26	27	28							
DOWNLINK										
1	2	3	4	5	6	7	8	10	11	12
13	14	15	16	17	18	19	20	21	22	23
25	26	27	28							
RUN TEST		PREV TEST	PREV TEST	RETURN						

GICB BDS 1,C		AVAIL	BAT	2.5 Hr		
BDS=1,C SPECIFIC SERV #5						
DF20 AA=3AC421 (16542041)						
MB=000000FFFFFFFF						
:E,1	:E,2	:E,3	:E,4	:E,5	:E,6	:E,7
:E,8	:E,9	:E,A	:E,B	:E,C	:E,D	:E,E
:E,F	:F,0	:F,1	:F,2	:F,3	:F,4	:F,5
:F,6	:F,7	:F,8	:F,9	:F,A	:F,B	:F,C
:F,D	:F,E	:F,F				
RUN TEST		PREV TEST	PREV TEST	RETURN		

GICB BDS 1,E		AVAIL	BAT	2.5 Hr							
BDS=1,E MSP CAP RPT 29-56											
DF20 AA=3AC421 (16542041)											
MB=FFFFFFFFFFFFFF											
UPLINK											
29	30	31	32	33	34	35	36	37	38	39	40
41	42	43	44	45	46	47	48	49	50	51	52
53	54	55	56								
DOWNLINK											
29	30	31	32	33	34	35	36	37	38	39	40
41	42	43	44	45	46	47	48	49	50	51	52
53	54	55	56								
RUN TEST		PREV TEST	PREV TEST	RETURN							

Uses UF4/5 Reply Length Long, BDS 1,8 through 1,C register requests: Receives DF20/21 reply and decodes MB message field containing BDS register contents and displays Mode S Specific Service GICB Capability Reports #1 through #5.

AA (Aircraft Address) in HEX and (OCTAL) MB message field displayed in 14 digit HEX format.

Mode S Specific Service GICB Capability Reports advise which BDS registers are currently available from the transponder for data download via GICB protocol.

NOTE: ADLP (Air Data Link Processor) must be installed or transponder must have embedded ADLP to receive data from subsystem.

NOTE: Refer to ICAO manual on Mode S specific services DOC 9688-AN/952 and RTCA DO-260A V2 for detailed description of data fields

GICB BDS 1,F		AVAIL	BAT	2.5 Hr		
BDS=1,F MSP CAP RPT 57-63						
DF20 AA=3AC421 (16542041)						
MB=FFFFFFFFFFFFFF						
UPLINK						
57	58	59	60	61	62	63
DOWNLINK						
57	58	59	60	61	62	63
RUN TEST		PREV TEST	PREV TEST	RETURN		

Uses UF4/5 Reply Length Long, BDS 1,D through 1,F register requests: Receives DF20/21 reply and decodes MB message field containing BDS register contents and displays Mode S Specific Protocol Capability Reports 1,D MSP channels 1-28, 1,E MSP Channels 29-56, 1,F MSP channels 57-63.

AA (Aircraft Address) in HEX and (OCTAL)
 MB message field displayed in 14 digit HEX format.

Mode S Specific Protocols (MSPs) utilize one or more of the 63 uplink or downlink channels provided by this protocol to transfer data in either short or long form MSP packets from the GDLP (Ground Data Link Processor) to the ADLP (Airborne Data Link Processor) or vice versa. The available channels are displayed over three screens BDS 1,D BDS 1,E and BDS 1,F.

NOTE: Refer to ICAO manual on Mode S specific services DOC 9688-AN/952 and RTCA DO-260A V2 for detailed description of data fields

GICB BDS 2,0

GICB BDS 2,0		AVAIL		BAT 2.5 Hr	
BDS=2,0 FLIGHT ID					
DF20 AA=3AC421 (16542041)					
MB=00000000000000					
FLIGHT ID=UA66121					
RUN TEST		PREV TEST		PREV TEST	
				RETURN	

Uses UF4/5 Reply Length Long, BDS 2,0 register request: Receives DF20/21 reply and decodes MB message field containing BDS register contents and displays AIS Flight ID.

AA (Aircraft Address) in HEX and (OCTAL)
 MB message field displayed in 14 digit HEX format.

Flight Id is seven characters.

GICB BDS 2,1

GICB BDS 2,1		AVAIL BAT 2.5 Hr	
BDS=2,1 AIRCRAFT REG #			
DF20 AA=3AC421 (16542041)			
MB=00000000000000			
ARN=12345AB			
AR =AA			
RUN TEST		PREV TEST	PREV TEST
RETURN			

Uses UF20/21 BDS 2,1 register request:
Receives DF20/21 reply and decodes MB message field containing BDS register contents and displays Aircraft Registration Number.

AA (Aircraft Address) in HEX and (OCTAL)
MB message field displayed in 14 digit HEX format.

ARN (Aircraft Registration Number) up to seven characters.

AR (Airline Registration) two characters.

GICB BDS 3,0

GICB BDS 3,0		AVAIL BAT 2.5 Hr	
BDS=3,0 ACAS ARA			
DF20 AA=3AC421 (16542041)			
MB=00000000000000			
TIDB= 70 deg			
TIDA= 32000 ft		TIDR= 1.00 nm	
ARA=11101010000000		TID=3A4518	
RAC=1010		RAT=1 MTE=3	
THREAT ADDRESS=N/A			
TTI=2-ALT/RANGE/BEARING DATA			
RUN TEST		PREV TEST	PREV TEST
RETURN			

Uses UF4/5 Reply Length Long, BDS 3,0 register request: Receives DF20/21 reply and decodes MB message field containing BDS register contents and displays ACAS Active Resolution Advisory data.

AA (Aircraft Address) in HEX and (OCTAL)
MB message field displayed in 14 digit HEX format.

ARA (Active Resolution Advisories) bits 41-54 displayed in binary.

RAC (Resolution Advisory Compliment) bit 55-58 displayed in binary.

RAT (RA Terminated) indicator bit 59 displayed in binary. Note: Normally 0 until an RA is terminated, then will be 1 for 18 seconds.

TIDA (Threat Identity Data Altitude) displayed in feet.

N/A (Not Available)

Note: Only displayed when TTI = 2, Intruder Not Mode S Equipped.

TID (Threat Identity Data) Mode S address (HEX) of the threat. Note: Only displayed when TTI = 1.

TIDR (Threat Identity Data Range) in nm.

N/A (Not Available)

Note: Only displayed when TTI = 2, Intruder Not Mode S Equipped.

TIDB (Threat Identity Data Bearing) in degrees.

N/A (Not Available)

NOTE: Only displayed when TTI = 2, Intruder Not Mode S Equipped.

THREAT ADDRESS (Mode S threat address)
displayed in 6 HEX digits

N/A (Not Available)

Note: Only displayed when TTI = 1.

MTE (Multiple Threat Encounter) displayed in
1 bit binary.

TTI (Threat Type Indicator)

Indications:

0-NO DATA

1-MODE S ADDRESS

2-ALT/RANGE/BEARING DATA

3-NOT ASSIGNED

NOTE: Refer to ICAO Annex 10, Vol III, Part
1, Chapter 5 and RTCA-DO-260A V2
for detailed description of data
fields. Also refer to RTCA D0-185A
para 2.2.3.9.3.2.3 MB fields used by
TCASII

GICB BDS 4,0

GICB BDS 4,0		AVAIL BAT 2.5 Hr	
BDS=4,0 VERT INTENT			
DF20 AA=3AC421 (16542041)			
MB=00000000000000			
MCP/FCU SEL ALT= 65536 ft			
FMS SEL ALT= 65536 ft		APP MODE=YES	
SOURCE INFO=YES		MODE INFO=YES	
TARGET ALT =FCU/MCP SEL ALT			
VNAV HOLD MODE ACTIVE=YES			
ALT HOLD MODE ACTIVE =YES			
BARO PRES SET=1100.0 mb			
RUN TEST	PREV TEST	PREV TEST	RETURN

Uses UF4/5 Reply Length Long, BDS 4,0
register request: Receives DF20/21 reply and
decodes MB message field containing BDS
register contents and displays Vertical Intent.

AA (Aircraft Address) in HEX and (OCTAL)
MB message field displayed in 14 digit HEX
format.

NOTE: ADLP (Air Data Link Processor) must
be installed or transponder must
have embedded ADLP to receive
data from subsystem.

MCP/FCU SEL ALT (Mode Control
Panel/Flight Control Unit Selected Altitude)
Indications in feet.

N/A (Not Available)

FMS SEL ALT (Flight management System)
Indications in feet.

N/A (Not Available)

TARGET ALT (Target Altitude)

Indications:

N/A (Only when SOURCE INFO is NO)

UNKNOWN,

AIRCRAFT ALT,

FCU/MCP SEL ALT,

FMS SEL ALT

SOURCE INFO (Target Altitude Source
Information)

Indications:

YES (Source information Provided),

NO (No Source Information Provided)

BARO PRES SET (Barometric Pressure set)

Indications:

N/A (Not Available)

800 to 1209.5 in mb.

VNAV HOLD MODE (Vertical Navigation Mode)

Indications:

YES,

NO (Not Active)

ALT HOLD MODE (Altitude Hold Mode)

Indications:

YES,

NO (Not Active)

APP MODE (Approach Mode)

Indications:

YES,

NO (Not Active)

MODE INFO (Mode Information)

Indications

YES (Mode Information Provided),

NO (No Mode Information Provided).

NOTE: Refer to ICAO manual on Mode S specific services DOC 9688-AN/952 and RTCA DO-260A V2 for detailed description of data fields.

GICB BDS 4,1

GICB BDS 4,1		AVAIL BAT 2.5 Hr	
BDS=4,1 WAYPOINT NAME			
DF20 AA=3AC421 (16542041)			
MB=00000000000000			
WAYPOINT NAME=DFW			
RUN TEST		PREV TEST	PREV TEST
		RETURN	

Uses UF4/5 Reply Length Long, BDS 4,1 register request: Receives DF20/21 reply and decodes MB message field containing BDS register contents and displays Waypoint Name.

AA (Aircraft Address) in HEX and (OCTAL) MB message field displayed in 14 digit HEX format.

NOTE: ADLP (Air Data Link Processor) must be installed or transponder must have embedded ADLP to receive data from subsystem.

WAYPOINT NAME 9 ICAO character name

NOTE: Refer to ICAO manual on Mode S specific services DOC 9688-AN/952 for detailed description of data fields.

GICB BDS 4,2

GICB BDS 4,2		AVAIL BAT 2.5 Hr	
BDS=4,2 WAYPOINT POS			
DF20 AA=3AC421 (16542041)			
MB=0000000000000000			
LATITUDE = 32 53 48 N			
LONGITUDE= 97 02 16 W			
CROSSING ALTITUDE= 32,000 ft			
RUN TEST	PREV TEST	PREV TEST	RETURN

Uses UF4/5 Reply Length Long, BDS 4,2 register request: Receives DF20/21 reply and decodes MB message field containing BDS register contents and displays Waypoint Position.

AA (Aircraft Address) in HEX and (OCTAL)
MB message field displayed in 14 digit HEX format.

NOTE: ADLP (Air Data Link Processor) must be installed or transponder must have embedded ADLP to receive data from subsystem.

LATITUDE decoded format in degrees, minutes and seconds North or South.

LONGITUDE decoded format in degrees, minutes and seconds East or West.

CROSSING ALTITUDE range
0 to 131068 ft.

NOTE: Refer to ICAO manual on Mode S specific services DOC 9688-AN/952 for detailed description of data fields.

GICB BDS 4,3

GICB BDS 4,3		AVAIL BAT 2.5 Hr	
BDS=4,3 WAYPOINT DETAILS			
DF20 AA=3AC421 (16542041)			
MB=0000000000000000			
BEARING TO WAYPOINT= 110.0 deg			
TIME TO GO= 25.0 min			
DISTANCE TO GO= 100.0 nm			
RESERVED=			
RUN TEST	PREV TEST	PREV TEST	RETURN

Uses UF4/5 Reply Length Long, BDS 4,3 register request: Receives DF20/21 reply and decodes MB message field containing BDS register contents and displays Waypoint Details.

AA (Aircraft Address) in HEX and (OCTAL)
MB message field displayed in 14 digit HEX format.

NOTE: ADLP (Air Data Link Processor) must be installed or transponder must have embedded ADLP to receive data from subsystem.

BEARING TO WAYPOINT
Indications: +/-180 degrees (1 decimal place)

TIME TO GO
Indications: 0 to 409.6 mins

DISTANCE TO GO
Indications: 0 to 6553.6 nm

RESERVED

NOTE: Refer to ICAO manual on Mode S specific services DOC 9688-AN/952 for detailed description of data fields.

GICB BDS 5,0

GICB BDS 5,0		AVAIL	BAT 2.5 Hr
BDS=5,0 TRACK & TURN			
DF20 AA=3AC421 (16542041)			
MB=00000000000000			
ROLL ANGLE= 40.1 deg			
GND SPEED = 500 kts			
TRUE AIR SPEED = 560 kts			
TRUE TRACK ANGLE= 90.3 deg			
TRACK ANGLE RATE= 4.0 deg/S			
RUN TEST	PREV TEST	PREV TEST	RETURN

Uses UF4/5 Reply Length Long, BDS 5,0 register request: Receives DF20/21 reply and decodes MB message field containing BDS register contents and displays Track and Turn Report.

AA (Aircraft Address) in HEX and (OCTAL)

MB message field displayed in 14 digit HEX format.

NOTE: ADLP (Air Data Link Processor) must be installed or transponder must have embedded ADLP to receive data from subsystem.

ROLL ANGLE.

Indications:

+/-90 degrees (1 decimal place)

TRUE TRACK ANGLE (True Track Angle)

Indications:

+/-180 degrees (1 decimal place).

RATE (True Track Angle Rate)

Indications:

+/- 0 to 16 degrees/second (1 decimal place)

GND SPEED (Ground Speed)

Indications:

0 to 2048 Kts, 2kt resolution.

TRUE AIR SPEED (True Air Speed)

Indications:

0 to 2048 Kts, 2kt resolution.

NOTE: Refer to ICAO manual on Mode S specific services DOC 9688-AN/952 and RTCA DO-260A V2 for detailed description of data fields.

GICB BDS 6,0

GICB BDS 6,0		AVAIL	BAT 2.5 Hr
BDS=6,0 HDG & SPEED			
DF20 AA=3AC421 (16542041)			
MB=00000000000000			
IND AIR SPEED = 512 kts MACH=0.729			
BARO ALT RATE= 1400 ft/min			
MAG HDG=180.0 deg			
INERT VERT VEL= 1400 ft/min			
RUN TEST	PREV TEST	PREV TEST	RETURN

Uses UF4/5 Reply Length Long, BDS 6,0 register request: Receives DF20/21 reply and decodes MB message field containing BDS register contents and displays Heading and Speed Report.

AA (Aircraft Address) in HEX and (OCTAL)

MB message field displayed in 14 digit HEX format.

NOTE: ADLP (Air Data Link Processor) must be installed or transponder must have embedded ADLP to receive data from subsystem.

IND AIR SPEED (Indicated Air Speed)

Indications:

N/A (Not Available)

0 to 1023 Kts, 1 kt resolution.

MACH (Mach Number)

Indications:

N/A (Not Available)

0 to 4.096 mach number, resolution to three decimal places.

BARO ALT RATE (Barometric Altitude Rate)

Indications:

N/A (Not Available)

-16384 to +16352 ft/ minute, resolution 32 ft/min.

MAG HDG (Magnetic Heading)

Indications:

N/A (Not Available)

-180 to 180 degrees.

GICB MON BDS 6,1 ST1

INERT VERT VEL (Inertial Vertical Velocity)
Indications:
N/A (Not Available)
-16384 to +16352 ft/ minute, resolution 32
ft/min.

NOTE: Refer to ICAO manual on Mode S
specific services DOC 9688-
AN/952 and RTCA DO-260A V2 for
detailed description of data fields.

GICB BDS 6,1 ST1		AVAIL	BAT 2.5 Hr
BDS=6,1 A/C STATUS		TYPE=28	
DF17 AA=3AC421 (16542041)			
ME=00000000000000			
SUBTYPE=1-EMERGENCY/PRIOR STATUS			
MODE A (4096) CODE=0000			
RESERVED=0000000000			
RUN TEST		PREV TEST	PREV TEST
		RETURN	

BDS: Indicates which BDS register is being displayed followed by its description.
6,1=Extended Squitter Aircraft Status.

TYPE: Specifies class and accuracy of data. Refer to table A-2 RTCA DO-260B.

DF17,18: Receives extended squitter decodes and displays Aircraft Status.

AA (Aircraft Address) in HEX and (OCTAL)

MB message field displayed in 14 digit HEX format.

NOTE: ADLP (Air Data Link Processor) must be installed or transponder must have embedded ADLP, to receive data from subsystem.

EMERG/PRIOR CODE (Emergency/Priority Status Coding).

Indications:

NO EMERGENCY,
GENERAL EMERGENCY,
LIFEGUARD/MEDICAL,
MINIMUM FUEL,
NO COMM,
UNLAWFUL INTERFNC,
DOWNED AIRCRAFT,
RESERVED.

MODE A (4096) CODE – DO-260B only
4 digit OCTAL field.

Indications:
0000 to 7777

RESERVED subfield, 12 digit HEX field
containing contents of bits 12 to 56 for
DO-260A, 25 to 56 for DO-260B.

SUB TYPE (Subtype Coding).

Indications:

0=NO INFO
1=EMERGENCY/PRIORITY STATUS
2=TCAS RA BROADCAST
3-7=RESERVED

GICB MON BDS 6,1 ST2

GICB BDS 6,1 ST2		AVAIL	BAT 2.5 Hr
BDS=6,1 A/C STATUS		TYPE=28	
DF17 AA=3AC421 (16542041)			
ME=00000000000000			
SUBTYPE=0-NO INFO			
TTI=			
TIDA=		TIDR=	
TIDB=		RAT=	
ARA=		RAC=	
MTE=			
THREAT ADDR=			
RUN TEST	PREV TEST	PREV TEST	RETURN

BDS: Indicates which BDS register is being displayed followed by its description.
6,1=Extended Squitter Aircraft Status.

TYPE: Specifies class and accuracy of data. Refer to table A-2 RTCA DO-260B.

DF17,18: Receives extended squitter decodes and displays Aircraft Status.

AA (Aircraft Address) in HEX and (OCTAL)

MB message field displayed in 14 digit HEX format.

NOTE: ADLP (Air Data Link Processor) must be installed or transponder must have embedded ADLP, to receive data from subsystem.

TTI (Threat Type Indicator)

Indications:

0=No identity data in TID

1=TID contains a Mode S transponder address

2=TID contains altitude, range and bearing data.

3=Not assigned

TIDA (Threat Identity Data – Altitude)

Indications:

Mode C altitude of the threat.

-1000 to 126700 ft res: 100 ft

TIDB (Threat Identity Data – Bearing)

Indications:

N/A (not available)

0 to 360 deg

GICB BDS 6,2 ST0

RAT (RA Terminated)

Indications:

0=ACAS is currently generating the RA indicated in the ARA subfield.

1=The RA indicated by the ARA subfield has been terminated.

TIDR (Threat Identity Data – Range)

Indications:

N/A (not available)

<0.05 nm

0.10 to 12.50 nm, resolution 0.10 nm

>12.55 nm

ARA (Active Resolution Advisories)

Indications:

14 bit subfield indicating characteristics of the RA.

MTE (Multiple Threat Encounter)

Indications:

0=One threat is being processed by the resolution logic (when ARA bit 41=0)

1=Two or more simultaneous threats are being processed by the resolution logic.

RAC (RACS Record) 4 bit subfield.

Indications:

Bit 55= Do not pass below

Bit 56=Do not pass above

Bit 57=Do not turn left

Bit 58=Do not turn right

0=Inactive

1=Active

THREAT ADDR (Aircraft Address of the Threat)

Indications:

Bits 63-86

GICB BDS 6,2 ST 0		AVAIL	BAT 2.5 Hr
BDS=6,2 TSS SUBTYPE 0		TYPE=29	
DF20 AA=3AC421 (16542041)			
MB=E97FFFF8001404			
VERT DATA/SOURCE INFO=FMS/NAV			
TARG ALT CAP=HLDG ALT-ACP-FMS/RNAV			
VERT MODE IND=ACQUIRING SIL=1			
TARG ALT TYPE=MSL NIC BARO=1			
TARG ALT= 31000 ft TARG HDG=240 deg			
TCAS/ACAS OPERATIONAL=YES RAA=NO			
HORIZ DATA AVAL/SOURCE IND=MCP/FCU			
HORIZ MODE IND=MAINTAINING NAC=0			
EMERG/PRIOR CODE=UNLAWFUL INTERFNC			
RUN TEST	PREV TEST	PREV TEST	RETURN

Uses UF20/21 BDS 0,7 register request: Receives DF20/21 reply and decodes MB message field containing BDS register contents and displays Squitter Status.

TSS SUBTYPE (Target State and Status Subtype)

Indications:

0= DO-260A

TYPE: Identifies the GICB Message Type.

DF20/21: Receives DF20/21 reply, decodes and displays Airborne Velocity.

NOTE: ADLP (Air Data Link Processor) must be installed or transponder must have embedded ADLP, to receive data from subsystem.

NOTE Installation must be in the airborne state to transmit target state and status.

NOTE: Autopilot must be engaged and stimulated by sensor data for some fields to display data.

AA (Aircraft Address) in HEX and (OCTAL)
MB message field displayed in 14 digit HEX format.

VERT DATA/SOURCE INFO (Vertical Data Available/Source Indicator)

Indications:

MCP/FCU (Mode Control Panel/Flight Control Unit),

HLD ALT (Holding Altitude),

FMS/RNAV (FMS/RNAV System).

TARGET ALT CAP (Target Altitude Capability)

Indications:

HLDG ALT (Capability for reporting Holding altitude only),

HLDG ALT-ACP (Capability for reporting either Holding altitude or Autopilot control panel selected altitude),

HLDG ALT-ACP-FMS/RNAV (Capability for reporting either Holding altitude or Autopilot control panel selected altitude, or any FMS/RNAV level off altitude).

RESERVED

VERT MODE IND (Vertical Mode Indicator)

Indications:

UNKNOWN, (Unknown Mode or Information unavailable),

ACQUIRING (Acquiring Mode),

MAINTAINING (Capturing or Maintaining Mode).

RESERVED

SIL (Surveillance Integrity Level) Indications:

0 (Unknown),

1 (1×10^{-3} per flight),

2 (1×10^{-5} per flight),

3 (1×10^{-7} per flight)

NIC BARO (Navigation Integrity Baro)

Indications:

0 (Gillham Not Cross Checked)

1 (Gillham Cross Checked)

TARGET HDG (Target Heading Angle)

Indications:

0 to 359 degrees.

INVALID

TCAS/ACAS OPERATIONAL (TCAS/ACAS Operational)

Indications:

YES,

NO.

RAA (TCAS/ACAS Resolution Advisory Active)

Indications:

YES,

NO.

TYPE Specifies class and accuracy of data. Refer to table A-2 RTCA DO-260A V2.

HORIZ DATA AVAIL/SOURCE IND (Horizontal Data Available/Source Indicator)

Indications:

NOT VALID (No Valid Horizontal Target State Data is available),

MCP/FCU (Mode Control Panel/Flight Control Unit selected track angle),

MAINTAIN (Maintain Current Heading or Track angle),

FMS/RNAV (FMS/RNAV System)

HORIZ MODE IND (Horizontal Mode Indicator)

Indications:

UNKNOWN (Unknown Mode or Information unavailable),

ACQUIRING (Acquiring Mode),

MAINTAINING (Capturing or Maintaining Mode),

RESERVED.

NAC (Navigation Accuracy Category - Position)

Indications:

0= $EPU \geq 18.52$ km (≥ 10 NM)

1= $EPU \leq 18.52$ km (10NM)

2= $EPU < 7.408$ km (4NM)

3= $EPU < 3.704$ km (2NM)

4= $EPU < 1852$ m (1NM)

5= $EPU < 926$ m (0.5NM)

6= $EPU < 555.6$ m (0.3NM)

7= $EPU < 185.2$ m (0.1NM)

8= $EPU < 92.6$ m (0.05NM)

9= $EPU < 30$ m

10= $EPU < 10$ m

11= $EPU < 3$ m

12=Reserved

13=Reserved

14=Reserved

15=Reserved

EMERG/PRIOR CODE (Emergency/Priority Status Coding).

Indications:

NO EMERGENCY,

GENERAL EMERGENCY,

LIFEGUARD/MEDICAL,

MINIMUM FUEL,

NO COMM,

UNLAWFUL INTERFNC,

DOWNED AIRCRAFT,

RESERVED.

GICB BDS 6,2 ST1

GICB BDS 6,2 ST 1		AVAIL	BAT 2.5 Hr
BDS=6,2 TSS SUBTYPE 1		TYPE=29	
DF20 AA=3AC421 (16542041)			
MB=00000000000000			
SUBTYPE=1	SIL=0	SIL SUP=1	
NAC=0	LNAV=0	VNAV =1	
MCP=1	AUTO P=1	AHME=1	
AP MODE=1	TCAS OP=NO		
SELECTED ALTITUDE=21792 ft TYPE=1			
BARO PRESSURE=843.2 mb NIC BARO=0			
SELECTED HEADING =- 59.7 deg			
SELECTED HEADING STATUS=1			
RESERVED ADS-R FLAG=1			
RUN TEST	PREV TEST	PREV TEST	RETURN

Uses UF20/21 BDS 0,7 register request:
 Receives DF20/21 reply and decodes MB message field containing BDS register contents and displays Squitter Status.

TSS SUBTYPE (Target State and Status Subtype)

Indications:

1= DO-260B

TYPE: Identifies the GICB Message Type.

DF20/21: Receives DF20/21 reply, decodes and displays Airborne Velocity.

NOTE: ADLP (Air Data Link Processor) must be installed or transponder must have embedded ADLP, to receive data from subsystem.

NOTE Installation must be in the airborne state to transmit target state and status.

NOTE: Autopilot must be engaged and stimulated by sensor data for some fields to display data.

AA (Aircraft Address) in HEX and (OCTAL)

MB message field displayed in 14 digit HEX format.

SUBTYPE= 1

SIL (Source Integrity Level) Indications:

- 0 (Unknown),
- 1 (1x10⁻³ per flight),
- 2 (1x10⁻⁵ per flight),
- 3 (1x10⁻⁷ per flight)

SIL SUP (SIL Supplement)

Indications:

- 0=Probability of exceeding NIC radius of containment is based on "per hour"
- 1=Probability of exceeding NIC radius of containment is based on "per sample"

NAC (Navigation Accuracy Category - Position)

Indications:

- 0=EPU \geq 18.52 km (\geq 10NM)
- 1=EPU \leq 18.52 km (10NM)
- 2=EPU<7.408 km (4NM)
- 3=EPU<3.704 km (2NM)
- 4=EPU<1852 m (1NM)
- 5=EPU<926 m (0.5NM)
- 6=EPU<555.6 m (0.3NM)
- 7=EPU<185.2 m (0.1NM)
- 8=EPU<92.6 m (0.05NM)
- 9=EPU<30 m
- 10=EPU<10 m
- 11=EPU<3 m
- 12=Reserved
- 13=Reserved
- 14=Reserved
- 15=Reserved

LNAV (Lateral Navigation Engaged)

Indications:

- 0=LNAV Mode is NOT Active
- 1=LNAV Mode is Active

VNAV (Vertical Navigation Engaged)

Indications:

- 0=VNAV Mode is NOT Active or Unknown
- 1=VNAV Mode is Active

MCP (Status of MCP/FCU)

Indications:

- 0=No Mode Information is being provided in "ME" bits 48, 49, 50 or 52 (Message bits 80, 81, 82 or 84)
- 1=Mode Information is deliberately being provided in "ME" bits 48, 49, 50 or 52 (Message bits 80, 81, 82 or 84)

AUTO P (Autopilot Engaged)

Indications:

- 0=Autopilot is NOT Engaged or Unknown (e.g., not actively coupled and flying the aircraft)
- 1=Autopilot is Engaged (e.g., actively coupled and flying the aircraft)

AHME (Altitude Hold Mode)

Indications:

- 0=Altitude Hold Mode is NOT Active or Unknown
- 0=Altitude Hold Mode is Active

AP MODE (Approach Mode)

Indications:

- 0=Approach Mode is NOT Active or Unknown
- 1=Approach Mode is Active

TCAS OP (TCAS Operational)

Indications:

- 0=TCAS System is NOT Operational (Any time RI \neq 3 or 4)
- 1=TCAS System is Operational (RI=3 or 4)

SELECTED ALTITUDE (Selected Altitude)

Indications:

0 to 65472 ft Res 32 ft

TYPE (Selected Altitude Type)

Indications:

0=MCP/FCU

1=FMS

BARO PRESSURE (Barometric Pressure)

Indications:

INVALID

800 to 1208 mb Res 0.8 mb

NIC BARO (Navigation Integrity Category - Baro)

Indications:

0=Barometric Altitude Invalid

1= Barometric Altitude Valid

SELECTED HEADING (Selected Heading)

Indications:

+/- 180 deg Res 180/256 (0.703125 deg)

SELECTED HEADING STATUS (Selected Heading Status)

Indications:

0=Invalid

1=Valid

GICB BDS 6,5 AIR

GICB BDS 6,5 AIR		AVAIL BAT 2.5 Hr	
BDS=6,5 A/C OP STATUS AIR TYPE =31			
DF20 AA=123456 (00432126)			
MB=F82AAA2AAA4AAF			
SUBTYPE=0-AIR		VERSION=2-DO-260B	
CC FMT =2AAA		ARV=1 TS=0 1090=0	
UAT=1 TC=2		ADSR=0 TCAS OP=1	
OM FMT=0		SDA=0 SAF=0 ATC=1	
RA=1 ID= NO			
HRZ REF=MAG NORTH		NIC-A=0 GVA=2	
NIC-BARO=1		SIL SUP=1 SIL=2	
NACP=10-EPU < 0.0054		ADSR(56)=1	
RUN TEST	PREV TEST	PREV TEST	RETURN

BDS: Indicates which BDS register is being displayed followed by its description.

6,5=Aircraft Operational Status, Airborne Subtype.

TYPE: Specifies class and accuracy of data. Refer to table A-2 RTCA DO-260B.

DF20/21: Displays which extended squitter is being received.

NOTE: Refer to RTCA/DO-260A, Appendix A, section §A.1.8, Figure A-10, replaces "BDS 6,3" with "BDS 6,5." Both BDS 6,3 and 6,5 are supported and data displayed is identical.

MB message field displayed in 14 digit HEX format.

NOTE: ADLP (Air Data Link Processor) must be installed or transponder must have embedded ADLP, to receive data from subsystem.

SUBTYPE

Indications:

0=AIR (Airborne Status message),

1=SUR (Surface Status message),

2=RESERVED,

3=RESERVED,

4=RESERVED,

5=RESERVED,

6=RESERVED,

7=RESERVED,

VERSION (MOPS Version Number)

Indications:

0-DO-260

1-DO-260A

2-DO-260B

CC FMT (Capability Class)

ME BITS 9-24 (airborne)

ME BITS 9-20 (surface)

0000-FFFF (airborne)

000-FFF (surface)

ARV (Air Referenced Velocity Report Capability) Only Available when Subtype= Airborne.

Indications:

N/A (Surface)

1 (Capability of sending messages to support Air-Referenced velocity reports),

0 (No Capability of sending messages to support Air-Referenced velocity reports)

TS (Target State Report Capability) Only Available when Subtype= Airborne

Indications:

N/A (Surface)

1 (Capability of sending messages to support Target State Reports),

0 (No Capability of sending messages to support Target State Reports)

1090 (1090 In Capability) – DO-260B

0=Not Capable

1=Capable

Aircraft has ADS-B 1090ES Receive

UAT (UAT In Capability)

Indications:

0=(No Capability to receive ADS-B UAT messages)

1=(Aircraft has capability to receive ADS-B UAT messages)

TC (Target Change Report Capability) Only Available when Subtype= Airborne.

Indications:

N/A (Surface)

0 (No capability for sending messages to support trajectory change reports) ,

1 (Capability of sending messages to support TC+0 report only),

2 (Capability of sending information for multiple TC reports).

3 (Reserved)

ADSR (Reserved for ADS-R flag)

Bit 20 of the ME field.

Included in Class Capabilities.

Indications:

0=Not Active

1=Active

Not TCAS – DO-260A

TCAS OP (TCAS Operational) – DO-260B

Indications:

0=(TCAS/ACAS Not Operational)

1=(TCAS/ACAS Operational)

OM FMT (Operational Mode Subfield)

Indications:

0 (TCAS RA Active, IDENT Switch Active, Receiving ATC Services)

1 (Reserved)

2 (Reserved)

3 (Reserved)

SDA (System Design Assurance Data)

Indications:

0=Unknown or No Safety Effect

1=Minor

2=Major

3=Hazardous

SAF (Single Antenna Flag)

Indications:

0=Dual Antenna

1=Single Antenna

ATC (Receiving ATC Services)

Indications:

1 (Aircraft receiving ATC services),

0 (Aircraft not receiving ATC services).

RA (TCAS RA Active)

Indications:

0=(TCAS II or ACAS resolution advisory inactive)

1=(TCAS II or ACAS resolution advisory active)

ID (Ident Switch)

Indications:

YES (Ident active),

NO (Ident not active).

HRZ REF (Horizontal Reference Direction)

Indications:

TRUE NORTH

MAG NORTH (Magnetic North)

NIC-A (Navigation Integrity Category – Supplement A)

Indications:

DO-260A only

0 (Rc unknown)

1 (Rc < 20 NM)

DO-260B only, Refer to Table 17

GICB BDS 6,5 SUR

BAQ (Barometric Altitude Quality) DO-260A
 GVA (Geometric Vertical Accuracy) DO-260B

Indications:

0=Unknown or >150 m

1= ≤ 150 m

2= ≤ 45 m

3=Reserved

NIC BARO (Navigation Integrity Baro)

Indications:

N/A (Surface)

0 (Gillham Not Cross Checked)

1 (Gillham Cross Checked)

SIL SUP (SIL Supplement) DO-260B only

Indications:

0=Probability of exceeding NIC radius of containment is based on "per hour"

1=Probability of exceeding NIC radius of containment is based on "per sample"

SIL (Surveillance Integrity Level)

Indications:

0 (Unknown),

1 (1×10^{-3} per flight),

2 (1×10^{-5} per flight),

3 (1×10^{-7} per flight)

NACP

Indications:

0=EPU>18.52 km (>10NM)

1=EPU<18.52 km (10NM)

2=EPU<7.408 km (4NM)

3=EPU<3.704 km (2NM)

4=EPU<1852 m (1NM)

5=EPU<926 m (0.5NM)

6=EPU<555.6 m (0.3NM)

7=EPU<185.2 m (0.1NM)

8=EPU<92.6 m (0.05NM)

9=EPU<30 m (0.016NM)

10=EPU<10 m (0.0054NM)

11=EPU<3 m (0.0016NM)

12=Reserved

13=Reserved

14=Reserved

15=Reserved

ADSR(56) (Reserved for ADS-R flag)

Bit 56 of the ME field.

Indications:

0=Not Active

1=Active

GICB BDS 6,5		SUR		AVAIL BAT 2.5 Hr	
BDS=6,5 A/C OP STATUS SUR TYPE =31					
DF20 AA=123456 (04432126)					
MB=0F92AAA2AAA4AAF					
SUBTYPE=1-SUR			VERSION=2-DO-260B		
CC FMT =2AA		B2 LOW=1		1090=0	
UAT=0		NIC-C=0		NACV=5	
OM FMT =0		SDA=0		SAF=0	
RA=1		ID=NO		ANT OFF=RT 2 M,20 M	
HRZ REF=MAG NORTH		NIC-A=0		POA=N/A	
TRK/HDG=NTRK		SIL SUP=1		SIL=2	
NACP=10-EPU < 0.0054		ADSR(56)=1			
LN/WD=10-<65M, <59.5M					
RUN TEST		PREV TEST		PREV TEST	
				RETURN	

BDS: Indicates which BDS register is being displayed followed by its description.

6,5=Aircraft Operational Status, Surface Subtype.

TYPE: Specifies class and accuracy of data. Refer to table A-2 RTCA DO-260B.

DF20/21: Displays which extended squitter is being received.

NOTE: Refer to RTCA/DO-260A, Appendix A, section §A.1.8, Figure A-10, replaces "BDS 6,3" with "BDS 6,5." Both BDS 6,3 and 6,5 are supported and data displayed is identical.

MB message field displayed in 14 digit HEX format.

NOTE: ADLP (Air Data Link Processor) must be installed or transponder must have embedded ADLP, to receive data from subsystem.

UBTYPE

Indications:

0=AIR (Airborne Status message),
1=SUR (Surface Status message),
2=RESERVED,
3=RESERVED,
4=RESERVED,
5=RESERVED,
6=RESERVED,
7=RESERVED,

VERSION (MOPS Version Number)

Indications:

0-DO-260
1-DO-260A
2-DO-260B

CC FMT (Capability Class)

ME BITS 9-24 (airborne)
ME BITS 9-20 (surface)
0000-FFFF (airborne)
000-FFF (surface)

B2 LOW

Indications:

N/A (Airborne)
0 (≥ 70 W)
1 (< 70 W)

1090 (1090 In Capability) – DO-260B

0=Not Capable
1=Capable

Aircraft has ADS-B 1090ES Receive

UAT (UAT In Capability)

Indications:

0=(No Capability to receive ADS-B UAT messages)
1=(Aircraft has capability to receive ADS-B UAT messages)

NIC-C (Navigation Integrity Category – Supplement C)

Indications: Refer to Table 17

NACV (Navigation Accuracy Category – Velocity)

Indications:

0=Unknown or ≥ 10 m/s
1= < 10 m/s
2= < 3 m/s
3= < 1 m/s
4= < 0.3 m/s

OM FMT (Operational Mode Subfield)

Indications:

0 (TCAS RA Active, IDENT Switch Active, Receiving ATC Services)
1 (Reserved)
2 (Reserved)
3 (Reserved)

SDA (System Design Assurance Data)

Indications:

0=Unknown or No Safety Effect
1=Minor
2=Major
3=Hazardous

SAF (Single Antenna Flag)

Indications:

0=Dual Antenna
1=Single Antenna

ATC (Receiving ATC Services)

Indications:

1 (Aircraft receiving ATC services),
0 (Aircraft not receiving ATC services).

RA (TCAS RA Active)

Indications:

0=(TCAS II or ACAS resolution advisory inactive)
1=(TCAS II or ACAS resolution advisory active)

ID (Ident Switch)

Indications:

YES (Ident active),
NO (Ident not active).

ANT OFF (GPS Antenna Offset Data)

Refer to Tables 19 and 20.

HRZ REF (Horizontal Reference Direction)

Indications:

TRUE NORTH
MAG NORTH (Magnetic North)

NIC-A (Navigation Integrity Category – Supplement A)

Indications:

DO-260A only
0 (Rc unknown)
1 (Rc < 20 NM)
DO-260B only, Refer to Table 17

POA (Position Offset Applied) DO-260A only

Indications:

N/A (Airborne)
0 (Position transmitted is not the ADS-B position reference point)
1 (Position transmitted is the ADS-B position reference point)

TRK/HDG (Used for surface ADS-B participants, surface position message heading or ground track determination bit)

Indications:

N/A (Airborne)
0 (Target Heading Reported)
1 (Track Angle Reported)

SIL SUP (SIL Supplement) DO-260B only

Indications:

0=Probability of exceeding NIC radius of containment is based on "per hour"

1=Probability of exceeding NIC radius of containment is based on "per sample"

SIL (Surveillance Integrity Level)

Indications:

0 (Unknown),

1 (1×10^{-3}) per flight),

2 (1×10^{-5}) per flight),

3 (1×10^{-7}) per flight)

NACP

Indications:

0=EPU>18.52 km (>10NM)

1=EPU<18.52 km (10NM)

2=EPU<7.408 km (4NM)

3=EPU<3.704 km (2NM)

4=EPU<1852 m (1NM)

5=EPU<926 m (0.5NM)

6=EPU<555.6 m (0.3NM)

7=EPU<185.2 m (0.1NM)

8=EPU<92.6 m (0.05NM)

9=EPU<30 m (0.016NM)

10=EPU<10 m (0.0054NM)

11=EPU<3 m (0.0016NM)

12=Reserved

13=Reserved

14=Reserved

15=Reserved

ADSR(56) (Reserved for ADS-R flag)

Bit 56 of the ME field.

Indications:

0=Not Active

1=Active

LN/WD (Aircraft Length and Width)

Aircraft or Vehicle Length

Indications: Length,Width

0=No Data or Unknown

1=<15m, <23m

2=<25m, <28.5m

3=<25m, <34m

4=<35m, <33m

5=<35m, <38m

6=<45m, <39.5m

7=<45m, <45m

8=<55m, <45m

9=<55m, <52m

10=<65m, <59.5m

11=<65m, <67m

12=<75m, <72m

13=<75m, <80m

14=<85m, <80m

15=<85m, <90m

4.6 UAT GENERAL

Universal Access Transceiver (UAT) is a multipurpose data link intended to support Automatic Dependent Surveillance (ADS-B), Flight Information Service-Broadcast (FIS-B), and Traffic Information Service-Broadcast (TIS-B).

UAT supports these multiple broadcast services by incorporating both time-slotted and random unslotted access.

There are two basic types of broadcast transmissions (messages) on the UAT channel: ADS-B Message and Ground Uplink Message. The ADS-B Message contains the aircraft State Vector and other information. The Ground Uplink Message is used by the ground stations to uplink flight information such as text and graphical weather data, advisories, and other aeronautical information to any aircraft that may be in the service volume of the ground station.

Regardless of type, each message has two basic components: message 'payload' consisting of user information and message 'overhead' which contains forward error correction code parity which supports the transfer of the data. For this test set, it is the message 'payload' that will be displayed to the user when monitoring UAT messages (UAT MON mode), or the user can manipulate the data to generate UAT messages (UAT GEN mode). The UAT GEN mode consists of: FIS-B, TIS-B, and ADS-B.

The UAT message is transmitted within a UAT frame which is one second long and begins at the start of each UTC second. Each frame is divided into two segments: Ground Segment in which Ground Uplink Messages are broadcast in one or more of 32 slots, and ADS-B Segment in which ADS-B Messages are broadcast by the aircraft.

In actual implementation, UAT-equipped aircraft will likely be in receiving range of more than one ground uplink stations. To ensure that these multiple uplink broadcasts can be received by the airborne UAT equipment without significant interference from one another, a time-slotted scheduling is applied to the uplinks. The Ground Uplink segment is divided into 32 ground broadcast slots where each ground station is assigned one or more of the slots to broadcast uplink message(s).

The ADS-B Message contains not only all aircraft-transmitted ADS-B Messages but also ground-transmitted TIS-B Messages. TIS-B is a ground-based service to ADS-B-equipped aircraft to provide State Vector and other data on non-ADS-B-equipped aircraft. The service is intended to provide ADS-B-equipped aircraft with a traffic picture in situations where not all aircraft are equipped with ADS-B.

4.6.1 UAT SETUP

UAT will use the port selection, antenna setup, and cable characteristics from the XPDR setup. See Section 4.4.2.

NOTE: In order to generate UAT transmissions, GPS sync must be established upon power up. This affects the FIS-B GEN, TIS-B GEN, and ADS-B GEN tests; the ADS-B MON test does not require GPS sync. GPS sync is attained when the GPS SYNC status appears on the upper right corner of the UAT screen. If GPS sync is lost, the test set will switch to an internal timebase so it can still generate UAT transmissions. However, the accuracy of the internal timebase will progressively degrade due to clock drift; therefore, it is recommended to have the GPS source available.

4.6.2 FIS-B GEN

Navigate to the UAT FIS-B GEN screen. See Section 2.17.

UAT FIS-B GEN		BAT 2.5 Hr	
		GPS SYNC	
REPORT: METAR	STN: KMCI	DAY/TIME: 030100Z	
DATA: 17018G23KT 10SM FEW220 25/07			
A2998 RMK A02 SLP147 T02500067			
GND LAT: 39 17 51.00 N			
LON: 94 42 50.00 W			
SLOT ID: 0			
RUN TEST	PREV PARAM	NEXT PARAM	RETURN

1 PPS: Indicates the timebase source of the 1 pulse per second timing reference.

Indications:

GPS SYNC –synchronized to GPS time

INT SYNC –synchronized to the test set internal timebase

NO SYNC –not synchronized

GPS: Indicates whether the 1 pulse/second timing reference is the GPS or internal

Indications: GPS AVAIL or GPS UNAVAIL

REPORT: Indicates weather information format type

Indications: METAR or TAF

STN: Indicates the ICAO airport code

DAY/TIME: Indicates the day and Zulu time.

Format: ddhhmmZ

dd=0 to 31 (day)

hh=0 to 23 (hour)

mm=0 to 59 (minute)

Z=Zulu time

DATA: Indicates the coded weather information.

GND LAT: Indicates the airport Latitude position.

Format: dd mm ss.ss c

dd=0 to 90 (degree)

mm=0 to 59 (minute)

ss.ss=0 to 59.99 (second)

c=N (North) or S (South)

LON: Indicates the airport Longitude position.

Format: dd mm ss.ss c

dd=0 to 180 (degree)

mm=0 to 59 (minute)

ss.ss=0 to 59.99 (second)

c=E (East) or W (West)

SLOT ID: Identifies the time slot of the message.

NOTE: When changing the METAR or TAF data to transmit, the DATA and GND LAT/LON are slaved to the STN.

The following METAR and TAF data sets are available for user selection:

METAR Data	
STN: KMCI DATA: 17018G23KT 10SM FEW220 25/07 A2998 RMK A02 SLP147 T02500067 GND LAT: 39 17 51.00 N GND LON: 94 42 50.00 W	Station: Kansas City International Airport Data translation: Winds from 170° at 18 kts gusting to 23 kts Visibility 10 or more miles Clouds few at 22000 ft Above Ground Level (AGL) Temperature 25°C / Dewpoint 7°C Pressure altimeter at 29.98 inches Hg Remark: Automated station with precipitation discriminator Sea level pressure 1014.7 mb Temperature 25°C with Dew point 6.7°C
STN: KAUS DATA: 28008KT 9999 BKN040 14/10 Q1024 GND LAT: 30 11 40.00 N GND LON: 97 40 12.00 W	Station: Austin-Bergstrom International Airport Data translation: Winds from 280° at 8 kts Clouds broken at 4000 ft AGL Temperature 14°C / Dewpoint 10°C Pressure altimeter 1024 mb
STN: KFFC DATA: 20007KT 9999 FEW023 15/12 Q1020 NOSIG GND LAT: 33 21 26.00 N GND LON: 84 34 19.00 W	Station: Atlanta Regional Airport Data translation: Winds from 200° at 7 kts Clouds few at 2300 ft AGL Temperature 15°C / Dewpoint 12°C Pressure altimeter 1020 mb No significant weather observed
STN: KBNA DATA: 33004KT 300V010 8000 SCT023 BKN100 26/23 Q1007 NOSIG RMK A2974 GND LAT: 36 7 36.00 N GND LON: 86 40 55.0 W	Station: Nashville International Airport Data translation: Winds from 330° at 4 kts Winds variable 300° to 10° Visibility of 8 km Clouds scattered at 2300 ft AGL Clouds broken at 10000 ft AGL Temperature 26°C / Dewpoint 23°C Pressure altimeter 1007 mb No significant weather observed Remark: Pressure altimeter 29.74 inches Hg
STN: PANC DATA: 36014KT CAVOK 17/11 Q1025 NOSIG GND LAT: 61 10 27.00 N GND LON: 149 59 54.00 W	Station: Anchorage International Airport Data translation: Winds from 360° at 14 kts Ceiling and Visibility are OK Temperature 17°C / Dewpoint 11°C Pressure altimeter 1025 mb No significant weather observed

TAF Data	
<p>STN: KMCI DATA: 0818/0918 19016G24KT P6SM SKC FM090000 15011KT P6SM SKC GND LAT: 39 17 51.00 N GND LON: 94 42 50.00 W</p>	<p>Station: Kansas City International Airport Data translation: Forecast valid from 8th 1800 UTC to 9th 0000 UTC: Winds from 190° at 16 kts gusting to 24 kts Visibility of 6 or more miles Clouds: clear skies Forecast valid from 9th 0000 to 1800 UTC: Winds from 150° at 11 kts Visibility of 6 or more miles Clouds: clear skies</p>
<p>STN: KAUS DATA: 0818/0924 05006KT 9999 FEW025 SCT035 BKN050 TX18/0915Z TN13/0906Z BECMG 0818/0820 VRB03KT BECMG 0909/0911 05006KT TEMPO 0912/0921 SCT050 GND LAT: 30 11 40.00 N GND LON: 97 40 12.00 W</p>	<p>Station: Austin-Bergstrom International Airport Data translation: Forecast valid from 8th 1800 UTC to 10th 0000 UTC: Winds from 50° at 6 kts Clouds: few at 2500 ft AGL Clouds: scattered at 3500 ft AGL Clouds: broken at 5000 ft AGL Maximum temperature of 18°C at time 0915 Zulu; Minimum temperature of 13°C at time 0906 Zulu Forecast period on 8th 1800 to 2000 UTC: Becoming: condition expected at 8th 2000 UTC Winds variable direction at 3 kts Forecast period on 9th 0900 to 1100 UTC: Becoming: condition expected at 9th 1100 UTC Winds from 50° at 6 kts Temporary forecast period on 9th 1200 to 2100 UTC: Clouds: scattered at 5000 ft AGL</p>

TAF Data (continued)

<p>STN: KFFC DATA: 0818/0924 35015KT CAVOK BECMG 0818/0820 36020G35KT CAVOK BECMG 0822/0824 35028G42KT CAVOK GND LAT: 33 21 26.00 N GND LON: 84 34 19.00 W</p>	<p>Station: Atlanta Regional Airport Data translation: Forecast valid from 8th 1800 UTC to 10th 0000 UTC: Winds from 350° at 15 kts Ceiling and Visibility are OK Forecast period on 8th 1800 to 2000 UTC: Becoming: condition expected at 8th 2000 UTC Winds from 360° at 20 kts gusting to 35 kts Forecast period on 8th 2200 UTC to 9th 0000 UTC: Becoming: condition expected at 9th 0000 UTC Winds from 350° at 28 kts gusting to 42 kts Ceiling and Visibility are OK</p>
<p>STN: KBNA DATA: 0815/0918 20015KT 9999 FEW010 BKN040 BECMG 0821/0823 19020G30KT TEMPO 0906/0912 20030G40KT GND LAT: 36 7 36.00 N GND LON: 86 40 55.00 W</p>	<p>Station: Nashville International Airport Data translation: Forecast valid from 8th 1500 to 2100 UTC: Winds from 200° at 15 kts Clouds: few at 1000 ft AGL Clouds: broken at 4000 ft AGL Forecast period on 8th 2100 UTC to 9th 1800 UTC: Becoming: condition expected at 8th 2300 UTC Winds from 190° at 20 kts gusting to 30 kts Temporary forecast period on 9th 0600 to 1200 UTC: Winds from 200° at 30 kts gusting to 40 kts</p>
<p>STN: PANC DATA: 0818/0924 03015G25KT CAVOK TEMPO 0903/0906 6000 NSC GND LAT: 61 10 27.00 N GND LON: 149 59 54.00 W</p>	<p>Station: Anchorage International Airport Data translation: Forecast valid from 8th 1800 UTC to 10th 0000 UTC: Winds from 30° at 15 kts gusting to 25 kts Ceiling and Visibility are OK Temporary forecast period on 9th 0300 to 0600 UTC: Visibility 6 km No significant cloud</p>

THIS PAGE INTENTIONALLY LEFT BLANK

4.6.3 TIS-B GEN

Navigate to the UAT TIS-B GEN screen. See Section 2.18.

UAT TIS-B GEN		BAT 2.5 Hr		
		GPS SYNC		
TARGETS: 5	UUT HDG:		0 deg	
BRG(deg) :	1	2	3	4
RNG(nm) :	0.0	0.0	0.0	0.0
ALT(100ft):	0	0	0	0
ALT RATE :	Climb	Climb	Climb	Climb
HDG(deg) :	0	0	0	0
UUT ALT :	0 ft			
UUT LAT :	0	0	0.00 N	
UUT LON :	0	0	0.00 E	
TIS-B SITE ID:	0	PYLD SEQ: 3,6,0,6		
RUN TEST		STORE DATA	PREV PARAM	NEXT PARAM
		RETURN		

1 PPS: Indicates the timebase source of the 1 pulse per second timing reference.

Indications:

GPS SYNC –synchronized to GPS time

INT SYNC –synchronized to the test set internal timebase

NO SYNC –not synchronized

TARGETS: Indicates the number of targets that will be simulated.

Indications: 1 to 5

UUT HDG: Indicates the UUT heading.

Indications: 0 to 359 (degree)

BRG: Indicates the target bearing relative to the UUT.

Indications: 0 to 359 (degree)

RNG: Indicates the target range relative to the UUT.

Indications: 0 to 40.0 (nm) at 0.1 nm increment

ALT: Indicates the target altitude relative to the UUT.

Indications: -3500 to 3500 (ft) at 100 ft increment

ALT RATE: Indicates the vertical direction of the target.

Indications:

Climb=Climbing

Dscn=Descending

Lvl=Level

HDG(deg): Indicates the target heading relative to the UUT.

Indications: 0 to 359 (degree)

UUT ALT: Indicates the UUT altitude.

Indications: -900 to 20000 (ft) at 25 ft increment

UUT LAT: Indicates the UUT Latitude position coordinate.

Format: dd mm ss.ss c

dd=0 to 90 (degree)

mm=0 to 59 (minute)

ss.ss=0 to 59.99 (second)

c=N (North) or S (South)

UUT LON: Indicates the UUT Longitude position coordinates.

Format: dd mm ss.ss c

dd=0 to 180 (degree)

mm=0 to 59 (minute)

ss.ss=0 to 59.99 (second)

c=E (East) or W (West)

TIS-B SITE ID: Identifies the ground station that provided the TIS-B information.

Indications:

0=No TIS-B information from this site

1 to 15=ground station that provided the TIS-B information

(Firmware Versions 03.15.01 or later and 04.14.00 or later only)

AG: Selects the Air/Ground State.

Indications:

AIR=Airborne

GND=Ground

PYLD SEQ: Sets the broadcast Payload Sequence. (Only applicable to firmware versions greater than 03.15.00)

Target State	3, 4, 6
--------------	---------

The broadcast of the Message Payloads depends on the Payload Type Code per RTCA DO-282A, Table 2-10:

Payload Message	Payload Type Code
State Vector	0, 1, 2, 3, 4, 5, 6
Auxiliary State Vector	1, 2, 5, 6
Mode Status	1, 3

The Payload Sequence (PYLD SEQ) parameter is derived from the payload sequence unique for each equipment class per RTCA DO-282A, paragraph 2.2.6.1.2:

Equipment Class	Payload Type Code A	Payload Type Code B	Payload Type Code C	Payload Type Code D
A0, A1L, A1H, B0, B1	1	0	2	0
A1H, B1*	3	6	0	6
A2	1	4	4	4
A3	1	4	5	4
B2, B3	1	0	0	0

*Applicable only if the installation can support transmission of Target State information.

Note that some Payload Sequence does not broadcast all four Payload Messages. For instance, the sequence for Equipment Class A0 (1,0,2,0) does not broadcast the Target State Payload Message. However, the sequence for Equipment Class A1H (3,6,0,6) will broadcast all four Payload Messages.

4.6.4 TIS-B GEN DATA

Press STORE DATA soft key to save or recall test data.

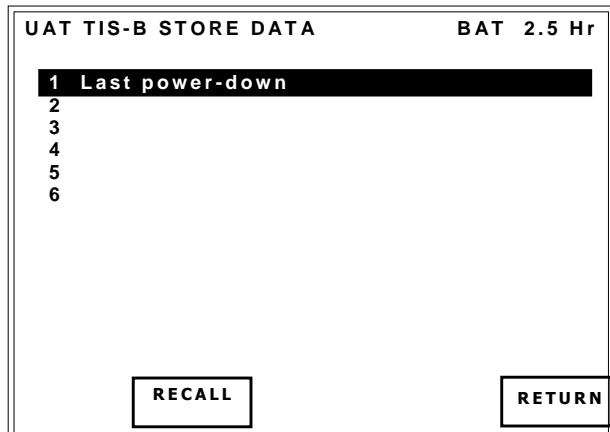

4.6.5 ADS-B GEN

Navigate to the UAT ADS-B GEN screen. See Section 2.19.

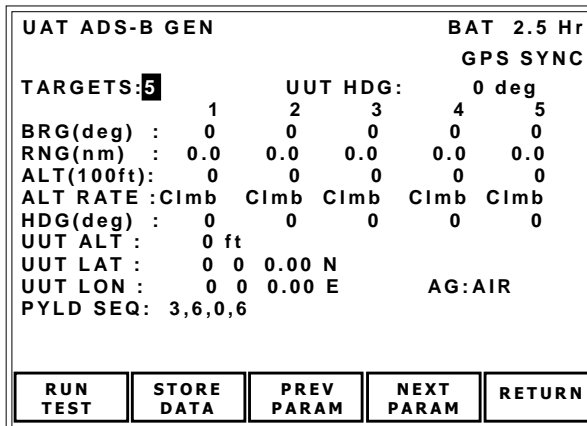

1 PPS: Indicates the timebase source of the 1 pulse per second timing reference.

Indications:

GPS SYNC –synchronized to GPS time

INT SYNC –synchronized to the test set internal timebase

NO SYNC –not synchronized

TARGETS: Indicates the number of targets that will be simulated.

Indications: 1 to 5

UUT HDG: Indicates the UUT heading.

Indications: 0 to 359 (degree)

BRG: Indicates the target bearing relative to the UUT.

Indications: 0 to 359 (degree)

RNG: Indicates the target range relative to the UUT.

Indications: 0 to 40.0 (nm) at 0.1 nm increment

ALT: Indicates the target altitude relative to the UUT.

Indications: -3500 to 3500 (ft) at 100 ft increment

ALT RATE: Indicates the vertical direction of the target.

Indications:

Climb=Climbing

Dscn=Descending

Lvl=Level

HDG(deg): Indicates the target heading relative to the UUT.

Indications: 0 to 359 (degree)

UUT ALT: Indicates the UUT altitude.

Indications: -900 to 20000 (ft) at 25 ft increment

UUT LAT: Indicates the UUT Latitude position coordinate.

Format: dd mm ss.ss c

dd=0 to 90 (degree)

mm=0 to 59 (minute)

ss.ss=0 to 59.99 (second)

c=N (North) or S (South)

UUT LON: Indicates the UUT Longitude position coordinates.

Format: dd mm ss.ss c

dd=0 to 180 (degree)

mm=0 to 59 (minute)

ss.ss=0 to 59.99 (second)

c=E (East) or W (West)

(Firmware Versions 03.15.01 or later and 04.14.00 or later only)

AG: Selects the Air/Ground State.

Indications:

AIR=Airborne

GND=Ground

PYLD SEQ: Sets the broadcast Payload Sequence. (Only applicable to firmware versions greater than 03.15.00)

The broadcast of the Message Payloads depends on the Payload Type Code per RTCA DO-282A, Table 2-10:

Payload Message	Payload Type Code
State Vector	0, 1, 2, 3, 4, 5, 6
Auxiliary State Vector	1, 2, 5, 6
Mode Status	1, 3
Target State	3, 4, 6

The Payload Sequence (PYLD SEQ) parameter is derived from the payload sequence unique for each equipment class per RTCA DO-282A, paragraph 2.2.6.1.2:

Equipment Class	Payload Type Code A	Payload Type Code B	Payload Type Code C	Payload Type Code D
A0, A1L, A1H, B0, B1	1	0	2	0
A1H, B1*	3	6	0	6
A2	1	4	4	4
A3	1	4	5	4
B2, B3	1	0	0	0

*Applicable only if the installation can support transmission of Target State information.

Note that some Payload Sequence does not broadcast all four Payload Messages. For instance, the sequence for Equipment Class A0 (1,0,2,0) does not broadcast the Target State Payload Message. However, the sequence for Equipment Class A1H (3,6,0,6) will broadcast all four Payload Messages.

4.6.6 ADS-B GEN DATA

Press STORE DATA soft key to save or recall test data.

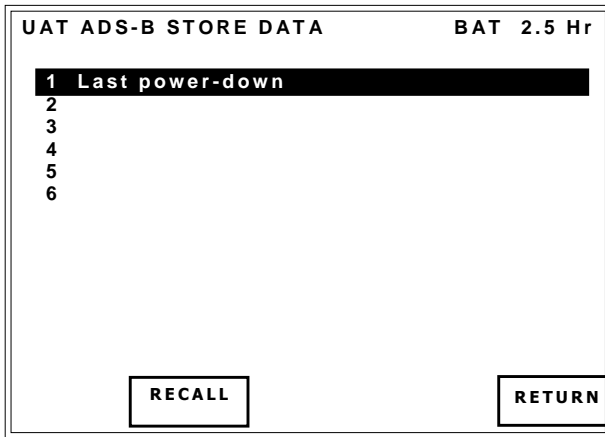

ADD QUAL: Indicates what the 24-bit address represents.

- Indications:
- 0=ADS-B ICAO
 - 1=ADS-B TEMP
 - 2=TIS-B/ADS-R
 - 3=TIS-B IDENT
 - 4=SURFACE
 - 5=ADS-B BEACON
 - 6=NON-ICAO
 - 7=RESERVED

PTC: The Payload Type Code identifies how the received message is decoded.

Indications: 0 to 6

AA: 24-bit Aircraft Address in HEX and (OCTAL)

4.6.7 ADS-B MON

Navigate to the UAT ADS-B MON screen.
State Vector Ground State

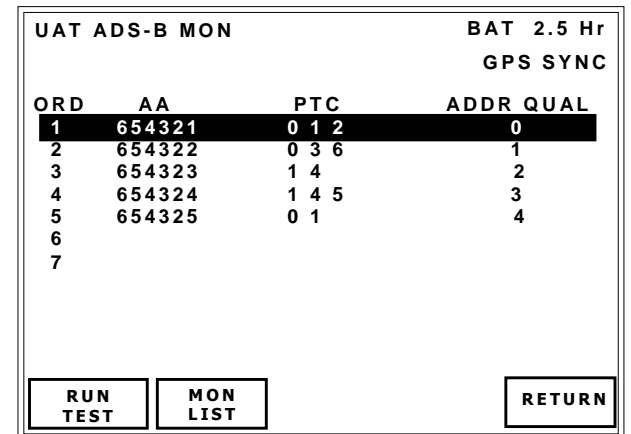
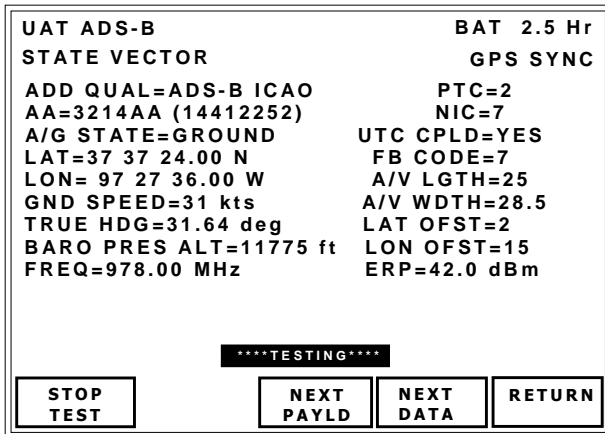

1 PPS: Indicates the timebase source of the 1 pulse per second timing reference.

Indications:

GPS SYNC –synchronized to GPS time

INT SYNC –synchronized to the test set internal timebase

NO SYNC –not synchronized

NIC: Indicates the Navigation Integrity Category where Rc is the Containment Radius.

NIC	Horizontal Containment
0	Rc Unknown
1	Rc < 20 nm
2	Rc < 8 nm
3	Rc < 4 nm
4	Rc < 2 nm
5	Rc < 1 nm
6	Rc < 0.6 nm
6	Rc < 0.3 nm
7	Rc < 0.2 nm
8	Rc < 0.1 nm
9	Rc < 0.0405 nm
10	Rc < 0.0135 nm
11	Rc < 0.004 nm
12	Reserved
13	Reserved
14	Reserved
15	Reserved

A/G STATE: Air/Ground State.

Indications: SUBSONIC, SUPERSONIC, or
GROUND

UTC CPLD: UTC Coupled indicates the status
of the ADS-B Transmitting
Subsystem.

Indications: YES or NO

LAT: Indicates the aircraft Latitude position coordinate.

Format: dd mm ss.ss c

dd=0 to 90 (degree)
 mm=0 to 59 (minute)
 ss.ss=0 to 59.99 (second)
 c=N (North) or S (South)

LON: Indicates the aircraft Longitude position coordinates.

Format: dd mm ss.ss c

dd=0 to 180 (degree)
 mm=0 to 59 (minute)
 ss.ss=0 to 59.99 (second)
 c=E (East) or W (West)

FB CODE or TISB ID: Indicates the Uplink Feedback Code for Address Qualifier 0 or 1, or indicates TIS-B Site ID for Address Qualifier 2, 3, or 6.

Indications: 0 to 7

A/V LGTH: Indicates the Aircraft or Vehicle length.

Indications: Length in meters.

Decima	A/V Length (meter)
0	No Data or Unknown
1	<15
2 or 3	<25
4 or 5	<35
6 or 7	<45
8 or 9	<55
10 or	<65
12 or	<75
14 or	<85

A/V WPTH: Indicates the Aircraft or Vehicle width.

Indications: Width in meters.

Decimal	A/V Width (meter)
0	No Data or Unknown
1	<23
2	<28.5
3	<34
4	<33
5	<38
6	<39.5
7	<45
8	<45
9	<52
10	<59.5
11	<67
12	<72.5
13	<80
14	<80
15	<90

GND SPEED: Indicates the Ground Speed.

Indications: Speed in knots.

Decimal	Ground Speed (kts)
0	Ground Speed info not available
1	0
2	1
3	2
...	...
1022	1021
1023	Overrange Indication

HDG: Indicates either No Heading, True Track Angle, Magnetic, or True Heading.

Indications: Heading in degrees.

Decimal	Track Angle/Heading
0	0
1	0.70
2	1.40
3	2.10
...	...
510	358.59
511	359.29

ALT: Indicates the aircraft Geometric or Barometric Pressure altitude.

Indications: Altitude in feet.

Decimal	Altitude (feet)
0	Altitude info not available
1	-1000
2	-975
...	...
40	-25
41	0
42	25
...	...
4094	101325
4095	Overrange Indication

LAT OFST: Indicates the Lateral Axis GPS antenna offset.

Indications: Direction + Offset

For example: 'R4 m' means Right 4 m offset

Decimal	Direction	GPS Offset
0	Left	No Data or Unk
1	Left	2
2	Left	4
3	Left	6
4	Right	0
5	Right	2
6	Right	4
7	Right	6

LON OFST: Indicates the Longitudinal Axis GPS antenna offset.

Indications: GPS Offset in meters

Decimal	GPS Offset (meter)
0	No Data or Unk
1	Offset applied by sensor
2	2
3	4
4	6
...	...
31	60

FREQ: Indicates the average carrier frequency measurement.

Indications: Frequency in MHz

ERP: Indicates the average Effective Radiated Power measurement of the received UAT signal.

Indications: Power in dBm

State Vector Airborne State

```

UAT ADS-B          BAT 2.5 Hr
STATE VECTOR      GPS SYNC
ADD QUAL=ADS-B ICAO  PTC=2
AA=3214AA (14412252)  NIC=7
A/G STATE=SUBSONIC  UTC CPLD=YES
LAT=37 37 24.00 N    FB CODE=7
LON= 97 27 36.00 W
NORTH VEL=311 kts
EAST VEL=236 kts
BARO VERT RATE=64 ft/min
BARO PRES ALT=2775 ft
FREQ=978.00 MHz      ERP=42.0 dBm
    
```

*****TESTING*****

STOP
TEST

NEXT
PAYLD

NEXT
DATA

RETURN

1 PPS: Indicates the timebase source of the 1 pulse per second timing reference.

Indications:

GPS SYNC –synchronized to GPS time

INT SYNC –synchronized to the test set internal timebase

NO SYNC –not synchronized

ADD QUAL: Indicates what the 24-bit address represents.

- Indications:
- 0=ADS-B ICAO
 - 1=ADS-B TEMP
 - 2=TIS-B/ADS-R
 - 3=TIS-B IDENT
 - 4=SURFACE
 - 5=ADS-B BEACON
 - 6=NON-ICAO
 - 7=RESERVED

PTC: The Payload Type Code identifies how the received message is decoded.

Indications: 0 to 6

AA: 24-bit Aircraft Address in HEX and (OCTAL)

NIC: Indicates the Navigation Integrity Category where Rc is the Containment Radius.

Indications: 0 to 15

NIC	Horizontal Containment
0	Rc Unknown
1	Rc < 20 nm
2	Rc < 8 nm
3	Rc < 4 nm
4	Rc < 2 nm
5	Rc < 1 nm
6	Rc < 0.6 nm
6	Rc < 0.3 nm
7	Rc < 0.2 nm
8	Rc < 0.1 nm
9	Rc < 0.0405 nm
10	Rc < 0.0135 nm
11	Rc < 0.004 nm
12	Reserved
13	Reserved
14	Reserved
15	Reserved

A/G STATE: Air/Ground State.

Indications: SUBSONIC, SUPERSONIC, or GROUND

UTC CPLD: UTC Coupled indicates the status of the ADS-B Transmitting Subsystem.

Indications: YES or NO

LAT: Indicates the aircraft Latitude position coordinate.

Format: dd mm ss.ss c

dd=0 to 90 (degree)
mm=0 to 59 (minute)
ss.ss=0 to 59.99 (second)
c=N (North) or S (South)

LON: Indicates the aircraft Longitude position coordinates.

Format: dd mm ss.ss c

dd=0 to 180 (degree)
mm=0 to 59 (minute)
ss.ss=0 to 59.99 (second)
c=E (East) or W (West)

FB CODE or TISB ID: Indicates the Uplink Feedback Code for Address Qualifier 0 or 1, or indicates TIS-B Site ID for Address Qualifier 2, 3, or 6.

Indications: 0 to 7

NORTH/SOUTH VEL: Indicates either North or South Velocity.

Indications: Velocity in kts.

Decimal	Subsonic (kts)	Supersonic (kts)
0	N/A	N/A
1	0	0
2	1	4
3	2	8
...
1022	1021	4084
1023	Overrange	Overrange

EAST/WEST VEL: Indicates either East or West Velocity.

Indications: Velocity in kts.

Decima	Subsonic (kts)	Supersonic (kts)
0	N/A	N/A
1	0	0
2	1	4
3	2	8
...
1022	1021	4084
1023	Overrange	Overrange

VERT RATE: Indicates either Barometric or Geometric Vertical Rate.

Indications: Rate in feet / minute.

Decimal	Vertical Rate (ft/min)
0	Vertical Rate info not available
1	0
2	64
3	128
...	...
510	32576
511	Overrange Indication

ALT: Indicates the aircraft Geometric or Barometric Pressure altitude.

Indications: Altitude in feet.

Decimal	Altitude (feet)
0	Altitude info not available
1	-1000
2	-975
...	...
40	-25
41	0
42	25
...	...
4094	101325
4095	Overrange Indication

FREQ: Indicates the average carrier frequency measurement.

Indications: Frequency in MHz

ERP: Indicates the average Effective Radiated Power measurement of the received UAT signal.

Indications: Power in dBm

Auxiliary State Vector

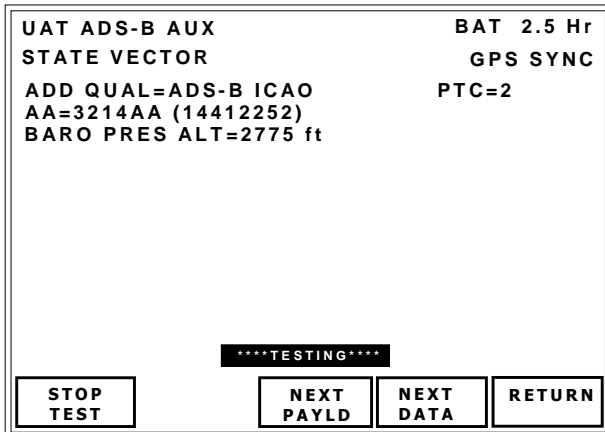

1 PPS: Indicates the timebase source of the 1 pulse per second timing reference.

Indications:

GPS SYNC –synchronized to GPS time

INT SYNC –synchronized to the test set internal timebase

NO SYNC –not synchronized

ADD QUAL: Indicates what the 24-bit address represents.

- Indications: 0=ADS-B ICAO
- 1=ADS-B TEMP
- 2=TIS-B/ADS-R
- 3=TIS-B IDENT
- 4=SURFACE
- 5=ADS-B BEACON
- 6=NON-ICAO
- 7=RESERVED

PTC: The Payload Type Code identifies how the received message is decoded.

Indications: 0 to 6

AA: 24-bit Aircraft Address in HEX and (OCTAL)

ALT: Indicates the aircraft Geometric or Barometric Pressure altitude.

Indications: Altitude in feet.

Decimal	Altitude (feet)
0	Altitude info not available
1	-1000
2	-975
...	...
40	-25
41	0
42	25
...	...
4094	101325
4095	Overrange Indication

Mode Status

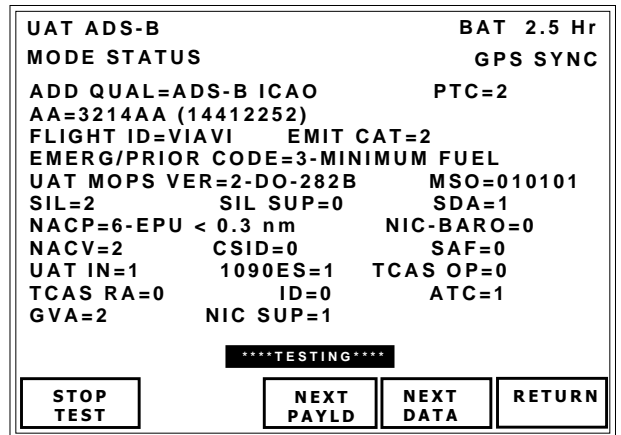

GPS: Indicates whether the 1 pulse/second timing reference is the GPS or internal

Indications: GPS AVAIL or GPS UNAVAIL

ADD QUAL: Indicates what the 24-bit address represents.

- Indications: 0=ADS-B ICAO
- 1=ADS-B TEMP
- 2=TIS-B/ADS-R
- 3=TIS-B IDENT
- 4=SURFACE
- 5=ADS-B BEACON
- 6=NON-ICAO
- 7=RESERVED

PTC: The Payload Type Code identifies how the received message is decoded.

Indications: 0 to 6

AA: 24-bit Aircraft Address in HEX and (OCTAL)

CALL SIGN/FLIGHT ID: Indicates either Call Sign or Flight ID.

Indications: Eight Base-40 encoded characters.

EMIT CAT: Indicates Emitter Category.

Indications: 0 to 21.

Decimal	Meaning
0	No information
1	Light (ICAO) <15500 lbs
2	Small 15500 to 75000 lbs
3	Large 75000 to 300000 lbs
4	High Vortex Large
5	Heavy >300000 lbs
6	Highly Maneuverable >5G
7	Rotorcraft
8	Unassigned
9	Glider/Sailplane
10	Lighter than air
11	Parachutist/Sky diver
12	Ultra light/Hang
13	Unassigned
14	Unmanned aerial vehicle
15	Space/Transatmospheric
16	Unassigned
17	Surface Emergency vehicle
18	Surface Service vehicle
19	Point obstacle
20	Cluster obstacle
21	Line obstacle
22	Reserved
...	...
39	Reserved

EMERG/PRIOR CODE: Indicates Emergency/Priority status.

Indications: 0-NO EMERGENCY
 1-GENERAL EMERGENCY
 2-LIFEGUARD/MEDICAL
 3-MINIMUM FUEL
 4-NO COMM
 5-UNLAWFUL INTERFNC
 6-DOWNED AIRCRAFT
 7-RESERVED

UAT MOPS VER: UAT Minimum Operational Performance Standard Version.

Indications: 0-RESERVED
 1-DO-282A
 2-DO-282B
 3-RESERVED
 4-RESERVED
 5-RESERVED
 6-RESERVED
 7-RESERVED

MSO: Indicates the 6 least significant bits of the transmit Message Start Opportunity.

Indications: Six character binary representation.

SIL: Indicates the Source Integrity Level which is the probability of exceeding the Navigation Integrity Category Containment Radius.

Indications: 0 to 3.

Decimal	SIL (per flight hr or per
0	Unknown
1	$\leq 1 \times 10^{-3}$
2	$\leq 1 \times 10^{-5}$
3	$\leq 1 \times 10^{-7}$

SIL SUP: Indicates the Source Integrity Level Supplement flag.

Indications: 0 or 1

Decimal	Meaning
0	Per hour
1	Per sample

SDA: Indicates System Design Assurance Data

Indications: 0 to 3

Decimal	Meaning
0	Unknown or No safety effect
1	Minor
2	Major
3	Hazardous

NACP: Indicates Navigation Accuracy Category for Position

Indications: 0-EPU \geq 10 nm

1-EPU < 10 nm

2-EPU < 4 nm

3-EPU < 2 nm

4-EPU < 1 nm

5-EPU < 0.5 nm

6-EPU < 0.3 nm

7-EPU < 0.1 nm

8-EPU < 0.05 nm

9-EPU < 0.016 nm

10-EPU < 0.0054 nm

11-EPU < 0.0016 nm

12-Reserved

13-Reserved

14-Reserved

15-Reserved

NIC-BARO: Indicates Barometric Altitude Integrity Code

Indications: 0 or 1

Decimal	Meaning
0	Gillham not cross checked
1	Gillham cross checked

NACV: Indicates horizontal velocity error Navigation Accuracy Category – Velocity

Indications: 0 to 7

Decimal	Error (meters/second)
0	Unknown or ≥ 10
1	< 10
2	<3
3	<1
4	<0.3
5	Reserved
6	Reserved
7	Reserved

CSID: Indicates the Call Sign Identification flag

Indications: 0 or 1

Decimal	Meaning
0	Flight plan ID
1	Call sign

SAF: Indicates the Single Antenna flag

Indications: 0 or 1

Decimal	Meaning
0	Diversity
1	Non-diversity

UAT IN: Indicates UAT IN capability

Indications: 0 or 1

Decimal	Meaning
0	No UAT receive capability
1	UAT receive capable

1090ES: Indicates ADS-B 1090 MHz Extended Squitter IN capability

Indications: 0 or 1

Decimal	Meaning
0	No 1090ES receive capability
1	1090ES receive capable

TCAS OP: Indicates TCAS/ACAS System Operational status

Indications: 0 or 1

Decimal	Meaning
0	TCAS/ACAS not operational
1	TCAS/ACAS operational

TCAS RA: Indicates TCAS/ACAS Resolution Advisory active flag

Indications: 0 or 1

Decimal	Meaning
0	Not active
1	Active

ID: Indicates Ident Switch active flag

Indications: NO=Not Active

YES=Active

ATC: Indicates receiving ATC Services flag

Indications: 0 or 1

Decimal	Meaning
0	Not receiving ATC Services
1	Receiving ATC Services

GVA: Indicates Geometric Vertical Accuracy

Indications: 0 to 3

Decimal	Meaning (meters)
0	Unknown or > 150
1	<=150
2	<=45
3	Reserved

NIC SUP: Indicates the Navigation Integrity Category Supplement flag where Rc is the Containment Radius.

Indications: 0 or 1

NIC	NIC Supp Flag	Horizontal Containment
0		Rc Unknown
1		Rc < 20 nm
2		Rc < 8 nm
3		Rc < 4 nm
4		Rc < 2 nm
5		Rc < 1 nm
6	0	Rc < 0.6 nm
6	1	Rc < 0.3 nm
7		Rc < 0.2 nm
8		Rc < 0.1 nm
9		Rc < 0.0405 nm
10		Rc < 0.0135 nm
11		Rc < 0.004 nm
12		Reserved
13		Reserved
14		Reserved
15		Reserved

Target State

```

UAT ADS-B                                BAT 2.5 Hr
TARGET STATE                             GPS SYNC
ADD QUAL=ADS-B ICAO                      PTC=2
AA=3214AA (14412252)
SAT=0-MCP/FCU                            SEL ALT=16352 ft
BARO PRESSURE=1004.0 mb                  MCP=1
SEL HEADING=85.0 deg
AUTO P=1                                VNAV=0    AHME=1
AP MODE=0                                LNAV=0
    
```

****TESTING****

STOP TEST	NEXT PAYLD	NEXT DATA	RETURN
-----------	------------	-----------	--------

1 PPS: Indicates the timebase source of the 1 pulse per second timing reference.

Indications:

GPS SYNC –synchronized to GPS time

INT SYNC –synchronized to the test set internal timebase

NO SYNC –not synchronized

ADD QUAL: Indicates what the 24-bit address represents.

- Indications: 0=ADS-B ICAO
 1=ADS-B TEMP
 2=TIS-B/ADS-R
 3=TIS-B IDENT
 4=SURFACE
 5=ADS-B BEACON
 6=NON-ICAO
 7=RESERVED

PTC: The Payload Type Code identifies how the received message is decoded.

Indications: 0 to 6

AA: 24-bit Aircraft Address in HEX and (OCTAL)

SAT: Indicates Selected Altitude Type.

- Indications:
 0-MCP/FCU
 1-FMS

SEL ALT: Indicates Selected Altitude.

Indications: Altitude in feet.

Decimal	Altitude (feet)
0	No data
1	0
2	32
3	64
...	...
2046	65440
2047	65472

BARO PRESSURE: Indicates Barometric Pressure.

Indications: Barometric pressure in mb.

Decimal	Pressure (+ 800 mb)
0	No data
1	0
2	0.8
3	0
...	...
510	407.2
511	408.0

MCP: Indicates MCP/FCU Mode status.

Indications: 0 or 1.

Decimal	Meaning
0	No mode indicator engaged
1	At least one mode indicator

SEL HEADING: Indicates Selected Heading.

Indications:

Decimal	Heading (degrees)
0	0.0
1	0.7
2	1.4
...	...
255	179.3

AUTO P: Indicates Autopilot mode.

Indications: 0 or 1

Decimal	Meaning
0	Engaged
1	Not engaged

VNAV: Indicates Vertical Navigation mode.

Indications: 0 or 1

Decimal	Meaning
0	Engaged
1	Not engaged

AHME: Indicates Altitude Hold mode.

Indications: 0 or 1

Decimal	Meaning
0	Engaged
1	Not engaged

AP MODE: Indicates Approach Mode

Indications: 0 or 1

Decimal	Meaning
0	Engaged
1	Not engaged

LNAV: Indicates Lateral Navigation mode

Indications: 0 or 1

Decimal	Meaning
0	Engaged
1	Not engaged

4.6.8 GPS STATUS

Navigate to the UAT ADS-B GEN screen.
See Section 2.18.

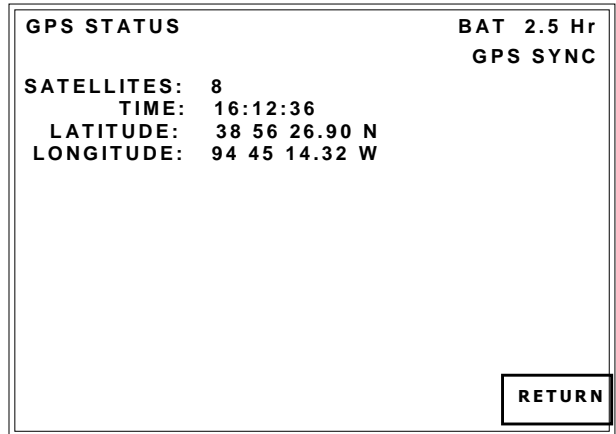

1 PPS: Indicates the timebase source of the 1 pulse per second timing reference.

Indications:

GPS SYNC –synchronized to GPS time

INT SYNC –synchronized to the test set internal timebase

NO SYNC –not synchronized

SATELLITES: Indicates the number satellites being tracked.

TIME: Indicates the UTC time.

Format: hh:mm:ss

hh=0 to 23 (hour)
mm=0 to 59 (minute)
ss=0 to 59 (second)

LATITUDE: Indicates the UUT Latitude position coordinate.

Format: dd mm ss.ss c

dd=0 to 90 (degree)
mm=0 to 59 (minute)
ss.ss=0 to 59.99 (second)
c=N (North) or S (South)

LONGITUDE: Indicates the UUT Longitude position coordinates.

Format: dd mm ss.ss c

dd=0 to 180 (degree)
mm=0 to 59 (minute)
ss.ss=0 to 59.99 (second)
c=E (East) or W (West)

4.7 DME

Press DME Mode Key to select DME functional mode. DME Test Screen is displayed.

DME		BAT 2.5 Hr		
VOR: 108.00 MHz	RFLVL: -2.0 dBm			
FREQ: 978 MHz	RATE: 650 kts	IN		
CHAN: 17X	RANGE: 450.00 nm			
% REPLY: 100	ECHO : OFF			
SQTR : ON	IDENT: OFF			
TX FREQ = 1041.00 MHz	ERP= 55.0 dBm			
P1 WIDTH= 3.500 us	PRF= 150 Hz			
P2 WIDTH= 3.500 us				
P1-P2 = 36.00 us(Y)				
UUTLVL = -38.2 dBm				
RUN TEST	PREV PARAM	NEXT PARAM	STOP RATE	IN/OUT

DME functional mode has a single test screen that provides all required control functions and measurement display. A Setup DME Screen allows user parameters to be entered.

User Controls:

Soft Keys:

RUN TEST:

Starts the DME Test. TEST RUNNING is displayed at the top of Screen.

NEXT PARAM:

Selects next control field. Includes selection of fields that have dedicated Keys.

PREV PARAM:

Selects previous control field. Includes selection of fields that have dedicated Keys.

STOP(START) RATE:

Stops or starts Range Rate.

IN/OUT:

Reverses simulated direction of aircraft.

Dedicated Keys and Control Fields:

FREQ Key:

Test Set reply Frequency is displayed in three linked units.

VOR (paired frequency MHz)

FREQ (ground to air frequency MHz)

CHAN (DME channel number)

Press Frequency Key to select each unit in sequence. Press DATA Key to select X or Y channel.

RF LVL Key:

Selects RF LVL field.

Note: When switching RF ports, RF LVL defaults to maximum value appropriate to attenuation range for selected port.

UUT LVL field displays RF level at UUT antenna. Calculated from RF LVL – Path Loss + Antenna Gain – Cable Loss.

RANGE Key:

Selects Range field.

RATE Key:

Selects Rate field.

Control Fields Selected with NEXT/PREV PARAM Soft Keys:

% REPLY:

Selectable in 1% steps. Range is 0% to 100%.

SQTR:

Selectable ON or OFF. Squitter must be on for DME to search and acquire track.

ECHO:

Selectable ON or OFF. Multi-path Reply Echo simulation at Fixed 30 nm, RF level -11 dB relative to RF LVL selected (Main Reply).

IDENT:

Selectable ON or OFF. Sends 1350 Hz tone with three letter station Identification. Defined in Setup DME Screen.

Measurement Parameters:

TX FREQ:

Measures and displays Interrogation Frequency in MHz.

ERP:

Measures and displays Interrogator ERP (Effective Radiated Power) in dBm, dBW or W peak. Units are selected in SETUP-GENERAL Screen.

PRF:

Measures and displays interrogator Pulse Repetition Frequency.

P1 WIDTH:

Measures and displays Interrogator P1 width in us.

P2 WIDTH:

Measures and displays Interrogator P2 width in us.

P1/P2:

Measures and displays interrogator P1 to P2 spacing and displays Mode X or Y, depending on spacing.

Control Field Power Up Defaults:

FREQ: 978 MHz.

RF LVL (UUT LVL): Maximum

RF LVL: Maximum

RATE: 0 kts IN

RANGE: 0 nm

% REPLY: 100

ECHO: OFF

SQTR: ON

IDENT: ON

4.7.1 DME SETUP

Refer to 1-1-2.8 and 1-1-2.9 for Antenna Connect procedures.

Setup DME Screen contains parameters which determine the operational characteristics of each functional mode of the Test Set.

NOTE: Setup Screen information is entered before conducting test operations.

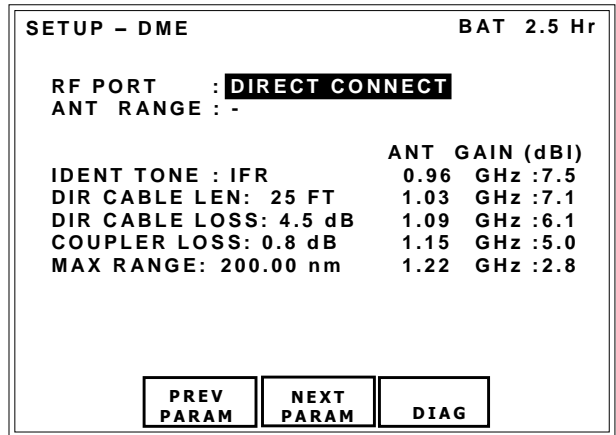

- | STEP | PROCEDURE |
|------|---|
| 1. | Press SETUP Select Key to display SETUP-DME Control Screen. |
| 2. | Set following parameters by pressing NEXT PARAM and PREV PARAM to select field. Use DATA Keys to slew the data. <ul style="list-style-type: none"> ● RF I/O CONNECTOR: <ul style="list-style-type: none"> Selects ANTENNA (ANT CONNECTOR) or DIRECT CONNECT via RF I/O Connector or DIR W/COUPLER. |

STEP	PROCEDURE
------	-----------

9. Verify ERP is for:
TSO'd DME >18,000 ft □ 250 W
(+54 dBm)
TSO'd DME <18,000 ft □ 50 W
(+47 dBm)
10. Set RATE to 600 kts and verify UUT DME distance indicator displays an outbound track, without breaking lock.
11. Set IN/OUT to IN and verify UUT DME distance indicator displays an inbound track, without breaking lock. Set RATE to 0 kts.
12. Set %REPLY to 0. Verify distance continues to be displayed and flag remains out of view for 8 s (± 4 sec). After memory times out, verify on UUT DME distance indicator that distance is not displayed and flag is in view. Verify Search PRF is □ 150 Hz.
13. Set %REPLY to 70 and UUT LVL to -79 dBm, verify UUT DME locks on. Set IDENT tone to ON. Verify 1350 Hz Ident morse is present on UUT DME audio. Set IDENT to OFF.
14. Set RANGE to 40 nm. Set ECHO to ON. Verify UUT DME does not break lock and range displayed on UUT DME indicator is 40 nm (± 0.5 nm). Set ECHO to OFF.
15. Set UUT LVL to -79 dBm and %REPLY to 70. Verify UUT DME is locked on. Adjust UUT LVL in -1 dB steps, allowing 15 sec between steps until UUT DME breaks lock. Verify UUT LVL is □ -83 dBm.

NOTE: OEM Test procedures should be followed.

NOTE: For Radiated Testing, Maximum UUT LVL settable depends on distance of Test Set from UUT and Setup DME Screen settings.

4.8 TCAS

The IFR 6000 fully tests ATCRBS and Mode S, ACAS, TCAS I, II (Traffic Alert Collision Avoidance System) and TAS (Traffic Advisory System).

The test set simulates an Intruder Aircraft converging on the position of the TCAS UUT. By manually defining a scenario or utilizing the factory default scenarios in test set memory, the Test Set operator can verify the correct TA's (Traffic Advisory) and RA's (Resolution Advisory) have occurred on the TCAS display.

The IFR 6000 is used with the directional antenna attached, allowing the user to move the test set to different locations and headings from the Aircraft UUT.

4.8.1 TCAS OPERATION CONCEPT

TCAS is a system which provides situational awareness of the surrounding airspace of an aircraft to the pilot and crew. TCAS establishes a volume of airspace around the aircraft based upon range, speed and altitude.

By working in-conjunction with the aircraft Transponder system, TCAS can determine the relative threat of an aircraft and issue visual and audible advisories to assist the crew in taking action that prevents a collision. Refer to 1-2-4, Table 3.

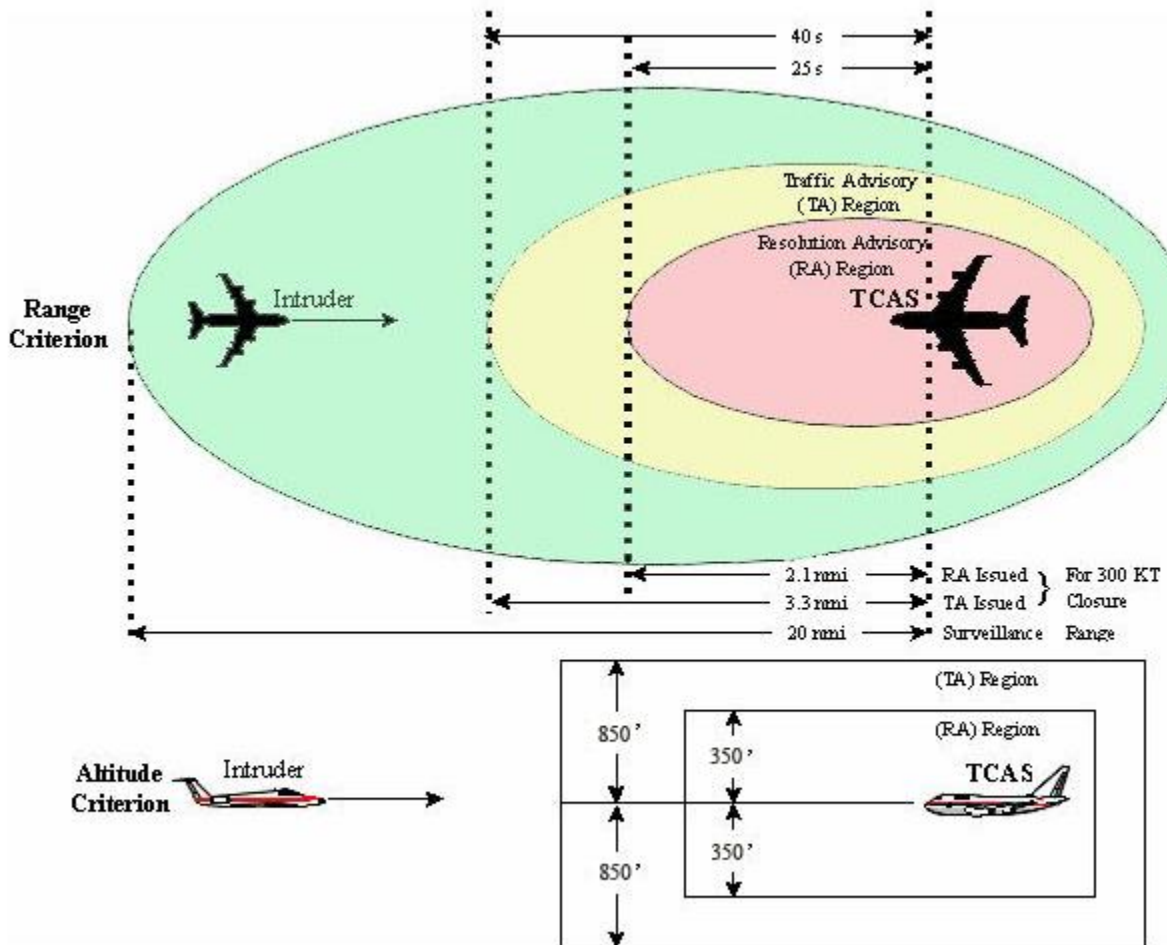





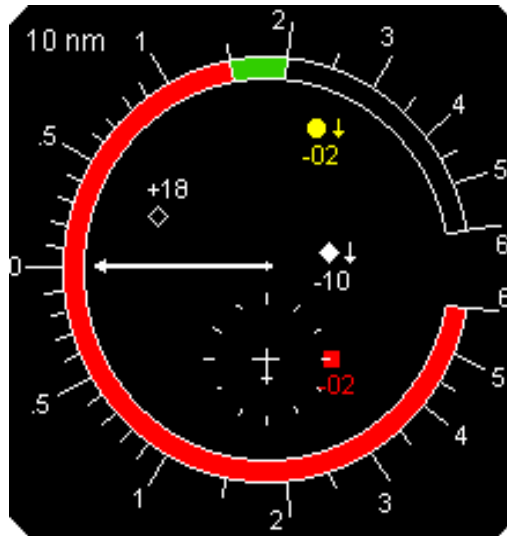

TCAS Protection Volume Example
5,000 ft to 10,000 ft
Figure 7

Your Altitude (ft)	SL	Tau (sec)		DMOD (nmi)		Altitude Threshold (ft)	
		TA	RA	TA	RA	TA	RA (ALIM)
<1000	2	20	N/A	0.30	N/A	850	N/A
1000 - 2350	3	25	15	0.33	0.20	850	300
2350 - 5000	4	30	20	0.48	0.35	850	300
5000 - 10,000	5	40	25	0.75	0.55	850	350
10,000 - 20,000	6	45	30	1.00	0.80	850	400
20,000 - 42,000	7	48	35	1.30	1.10	850	600
>42,000	7	48	35	1.30	1.10	1200	700

Protection Volume Parameters Versus Altitude
Table 3



Typical TCAS II Display
Figure 8

	<p>Non-Threat Traffic: An open white diamond indicates that an intruder's relative altitude is ± 1200 ft vertically or distance is beyond 6 nm range and not yet considered a threat.</p>		<p>Resolution Advisory: A solid red square indicates that the intruding aircraft is projected to be a collision threat. TCAS II calculates that the intruder has reached the point where a Resolution Advisory is necessary. The time to closest approach with the intruder is now between 15 and 35 sec depending on altitude. The symbol appears together with an appropriate audio warning and a vertical maneuver indication on the RA/VSI.</p>
	<p>Proximity Intruder Traffic: A filled white diamond indicates that the intruding aircraft is ± 1200 ft vertically and within 6 nm range, and still not considered a threat.</p>		<p>Numbers: Represents the intruder aircraft relative altitude ± 100 ft levels from aircraft.</p>
	<p>Traffic Advisory: A symbol change to a filled yellow circle indicates that the intruding aircraft is considered to be potentially hazardous. Depending on altitude TCAS II displays a TA when the time to CPA is between 20 and 48 sec.</p>		<p>Arrows: Indicate if the intruder aircraft is ascending or descending from relative position.</p>

THIS PAGE INTENTIONALLY LEFT BLANK.

4.8.2 TCAS / (TAS) TESTING

The IFR 6000 provides three basic TCAS test functions.

TCAS Screen

Provides simulated encounters with intruding Mode S or Mode C aircraft. Measures Peak Pulse Power or ERP (Effective Radiated Power) and TX Frequency of the interrogator.

Monitor Screens

Surveillance Monitor:

Displays surveillance interrogations UF0 and UF16 field content, surveillance interval and count.

Broadcast Monitor:

Displays TCAS broadcast interrogations UF16 field content, broadcast interval and count.

Displays RA broadcast interrogations UF16 field content, broadcast interval and count.

Whisper-Shout Monitor:

Displays whisper-shout sequence interval, count of interrogations with no suppression, S1, P2 or both S1 and P2. Interrogation spacing is also displayed.

Setup Screens

Sets operational range and height from test set antenna to UUT antenna, cable loss, antenna gain parameters simulated and transponder Mode S address.

Reply Parameters Screen allows control over Mode S DF0, DF11 and DF16 field content.

4.8.3 SETUP

SETUP-TCAS SCREEN:

SETUP-TCAS Screen contains parameters which determine operational characteristics of the TCAS Functional Mode. Unless otherwise stated, last used values are retained on Power-Up.

NOTE: Enter Setup Screen information before conducting test operations.

SETUP-TCAS		BAT 2.5 Hr	
RF PORT:	ANTENNA		
ANT RANGE	: 12 ft		
ANT HEIGHT	: 1 ft		
UUT ADDRESS:	AUTO		
	MANUAL AA:000000		
ANT CABLE LEN:	25 FT		
ANT CABLE LOSS:	4.5 dB	ANT GAIN(dBi)	
SQUITTERS:	ON	1.03 GHz:	7.1
ALT REPORTING:	ON	1.09 GHz:	6.1
DISPLAYED ALT:	RELATIVE		
TEST SET AA:	A92493		
REPLY PARAM	PREV PARAM	NEXT PARAM	DIAG
			STORE/ RECALL

STEP	PROCEDURE
------	-----------

1. Press SETUP Select Key to display SETUP TCAS Screen.
2. Set following parameters by pressing NEXT PARAM and PREV PARAM to select field. Use DATA Keys to slew the data.
 - RF PORT:
Selects ANTENNA or DIRECT CONNECT via RF I/O Connector.

STEP	PROCEDURE	STEP	PROCEDURE
●	ANT CABLE LEN or DIR CABLE LEN or CPL CABLE LEN: Selections: 1 to 75 FT.	●	ANT HEIGHT: Test Set Antenna to TCAS antenna height difference (1 to 99 ft or 0.5 to 30.0 m).
●	CABLE LOSS field is automatically calculated. Cable loss may be manually entered by the user.	●	NOTE: UNITS parameter determines feet or meters.
●	ANT CABLE LOSS or DIR CABLE LOSS or CPL CABLE LOSS: Displays cable loss in dB (at 1090 MHZ). Figure marked on supplied RF coaxial cable	●	UUT ADDRESS: If AUTO is selected the test set interrogates the TCAS UUT Transponder with an ATRBS All Call, to obtain the Mode S address, which is used in subsequent Transponder interrogations to obtain the TCAS UUT altitude. If MANUAL is selected, the UUT address is obtained from the MANUAL AA field.
NOTE:	Cable loss range 0.0 to 9.9 dB.	●	MANUAL AA: User entered Transponder address for TCAS UUT Transponder.
Cable Len will automatically calculate cable loss in dB. Cable loss is automatically displayed.	NOTE: Based on VIAVI supplied cables, (25 and 50 foot cables optional)	●	SQUITTERS: Used to turn ON or OFF Simulated Mode S Transponder DF11 squitters containing address specified in TEST SET AA: field. Squitters are transmitted once per second and should be set to ON for normal interrogation/reply operation.
NOTE: 25 and 50 foot cable selection compensates for delay of VIAVI optional cables.	NOTE: To calculate cable length to enter, for non VIAVI supplied cables, use the following formula..	●	ALT REPORTING: Used to turn ON or OFF Simulated Transponder ATRBS Mode C or Mode S altitude information.
Lentered = $L * (0.68/V)$ L = physical length of cable V = Velocity factor of cable Where Lentered = the length value entered into ANT/DIR/CPL CABLE LEN field.	●	●	DISPLAYED ALT: With RELATIVE selected, simulated altitude displayed in ALT field of TCAS screen is relative to UUT Altitude (i.e., ± UUT altitude). With ABSOLUTE selected, simulated altitude displayed in ALT field of TCAS screen is actual altitude.
COUPLER LOSS: Displays coupler loss in dB (at 1090 MHZ). Figure marked on supplied coupler.	NOTE: Coupler loss range 0.0 to 9.9 dB.	●	TEST SET AA: Enter test set simulated Mode S Transponder address in HEX.
●	ANT GAIN: Entered in dBi, gain figures (0.0 to 20.9) for 1.03 and 1.096 GHz marked on supplied Directional Antenna.	3.	Press TCAS Mode Key to return to TCAS Test Screen.
●	ANT RANGE: Test Set Antenna to TCAS antenna horizontal range (6 to 250 ft or 2.0 to 75.0 m).		
NOTE:	UNITS parameter determines feet or meters.		

TCAS REPLY PARAMETERS SCREEN:

Press SETUP SELECT Key until TCAS-SETUP screen is displayed. Press REPLY PARAM Soft Key to display TCAS Reply Param Screen.

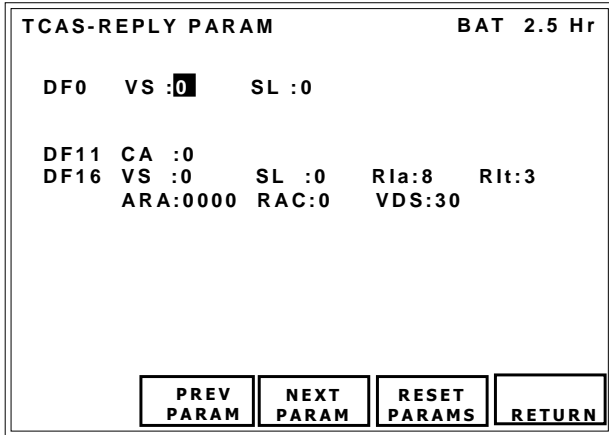

The reply parameters screen controls the content of the Mode S Replies DF0, DF11 and DF16 used in the TCAS test. The message fields allow the user to program capability information and various advisories to the TCAS interrogator.

NOTE: Refer to Appendix I for detailed descriptions of the following displayed Downlink Format (DF) fields and subfields. All fields are displayed in hexadecimal. Unless otherwise specified, both single and continuous SLEW key depressions change values by 1.

USER CONTROL SOFT KEYS

NEXT PARAM:

Selects next control field, including selection of fields that have dedicated keys.

PREV PARAM:

Selects previous control field, including selection of fields that have dedicated keys.

RESET PARAMS:

Resets all parameters to factory default.

RETURN:

Displays the SETUP-TCAS screen.

CONTROL FIELD SOFT KEYS

VS:

Enter vertical status. VS: field indicates intruding aircraft is airborne when '0' or on the ground when '1'. The VS: field is transmitted in DF0 and DF16.

SL:

Enter simulated IFR 6000 Sensitivity Level (1-2-4, Table 4)

NOTE:The SL: field contains simulated sensitivity level information and does not actually set the IFR 6000 to a particular Sensitivity Level.

INPUT DATA	DEFINITION
0	No Sensitivity Level reported
1	Operates at Sensitivity Level 1
2	Operates at Sensitivity Level 2
3	Operates at Sensitivity Level 3
4	Operates at Sensitivity Level 4
5	Operates at Sensitivity Level 5
6	Operates at Sensitivity Level 6
7	Operates at Sensitivity Level 7

SL: Field Valid Data
Table 4

CA:

Enter transponder Capability (1-2-4, Table 5). The Test Set transmits the CA: field in DF11 (squitter transmissions).

INPUT DATA	DEFINITION
0	No communications capability (surveillance only)
1	Not used
2	Not used
3	Not used
4	Have Comm-A and Comm-B capability (ground).
5	Have Comm-A and Comm-B capability (airborne).
6	Have Comm-A and Comm-B capability (ground or airborne).
7	DR is not equal to 0, or FS equals 2,3,4 or 5 (ground or airborne).

CA: Field Valid Data
Table 5

Rla:

Enter air-to-air Reply Information for an acquisition report. The Rla: field contains airspeed data. The field can be set from '0' to 'F' but only '8' to 'E' is valid (1-2-4, Table 6). The Test Set transmits the Rla: field in DF0 and DF16 when interrogator requests an acquisition report.

Rla: FIELD INPUT DATA	DEFINITION (AIRSPEED)
8	No data available
9	□75 kts
A	>75 kts and □150 kts
B	>150 kts and □300 kts
C	>300 kts and □600 kts
D	>600 kts and □1200 kts
E	>1200 kts

RI: Field (Acquisition) Valid Data
Table 6

Rlt:

Enter air-to-air Reply Information for a tracking report. The Rlt: field contains TCAS capability data. The field can be set from '0' to 'F' but only '0' '3' and '4' are valid (1-2-4, Table 7).

Rlt: FIELD INPUT DATA	DEFINITION (TCAS CAPABILITY)
0	No on-board TCAS
3	On-board TCAS has vertical-only resolution ability.
4	On-board TCAS has vertical and horizontal resolution ability.

RI: Field (Tracking) Valid Data
Table 7

RAC:

Enter simulated TCAS Resolution Advisory Complements. The RAC: field indicates current active Resolution Advisory Complements being received from all other TCAS aircraft with on-board resolution capability (1-2-4, Table 8). The test set transmits the RAC: field in DF16 (part of MV field).

INPUT DATA	DEFINITION
0	No resolution advisory complements
1	Don't turn right.
2	Don't turn left.
4	Don't climb.
8	Don't descend.
NOTE: The sum of the Input Data codes indicates multiple active resolution advisories are being received.	

RAC: Field Valid Data
Table 8

4.8.4 TCAS SCREEN

Press TCAS Mode Key until TCAS Test Screen is displayed.

ARA:

Enter simulated TCAS resolution advisory report. The ARA: field indicates all current Active Resolution Advisories being transmitted by the intruding aircraft (IFR 6000) (1-2-4, Table 9). The Test Set transmits the ARA: field in DF16 (part of MV field).

INPUT DATA	DEFINITION
0001	Don't turn right.
0002	Don't turn left.
0004	Turn right.
0008	Turn left.
0010	Don't climb faster than 2000 fpm.
0020	Don't climb faster than 1000 fpm.
0040	Don't climb faster than 500 fpm.
0080	Don't climb.
0100	Descend.
0200	Don't descend faster than 2000 fpm.
0400	Don't descend faster than 1000 fpm.
0800	Don't descend faster than 500 fpm.
1000	Don't descend.
2000	Climb.
NOTE: Data codes are added together to indicate multiple active resolution advisories are being transmitted.	

ARA: Field Valid Data
Table 9

VDS:

Enter MV message field content definition. Set the VDS: field to '30' for coordination reply messages (default value). The test set transmits the VDS: field in DF16 (part of MV field).

CLI:

Enter Coordination Lock Indicator ('0' is Off, '1' is On). The test set transmits the CLI: field in DF16 (part of MV field).

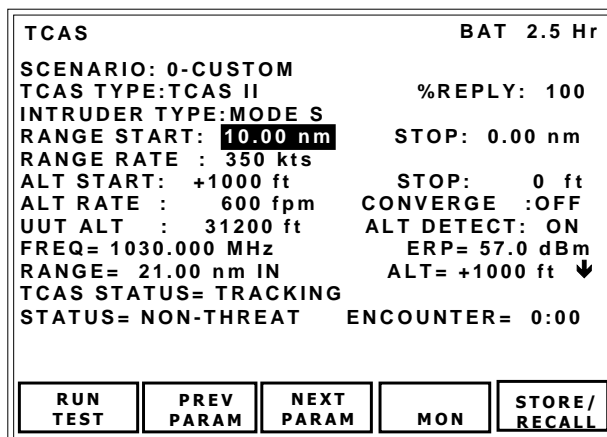

The TCAS screen provides simulated planned encounters with ATCRBS Mode C or Mode S intruders. The TCAS screen is used to verify audio and visual TCAS operation (Traffic and Resolution Advisories). Intruding flight patterns are programmed from the TCAS screen and stored in one of sixteen user named scenario data storage locations.

Eight factory pre-defined scenarios are provided which may be recalled, modified and stored under a user named scenario.

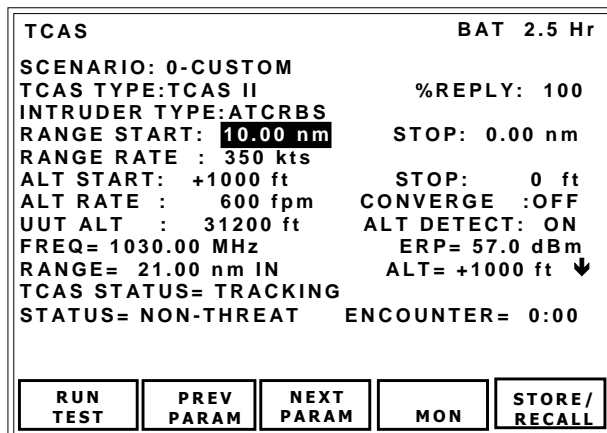

Calculation of Scenarios:

Ex: Assume intruder at 10,000 ft above UUT altitude. Intruder velocity is 600 kts and intruder distance is 20 nm.

Manual calculation of altitude rate to ensure convergence:

Select CONVERGE: OFF

STOP ALT= 0 ft, STOP RANGE= 0 nm.

$$\text{ALT RATE} = \frac{\text{ALT START} \times \text{RANGE RATE}}{\text{START RANGE} \times 60}$$

$$\text{ALT RATE} = \frac{10,000 \times 600}{20 \times 60}$$

ALT RATE = 5000 fpm

Auto calculation of altitude rate to ensure convergence:

Set the following:

RANGE START: 20 nm

RANGE RATE: 600 kts

ALT START: +10,000 ft

Select CONVERGE: ON. Altitude rate is automatically determined to achieve collision.

STOP (Range) and STOP (Alt) fields is cleared, allowing easy programming of random but converging scenarios.

STEP	PROCEDURE
1.	Refer to para 1-2-4.7 for Directional Antenna use and setup procedure.
2.	Press TCAS Mode Key to display TCAS Test Screen.
3.	Set following parameters by pressing NEXT PARAM and PREV PARAM to select field. Use DATA Keys to slew the data.
	USER CONTROLS SOFT KEYS
	RUN TEST: Starts the TCAS Test.
	NEXT PARAM: Selects next control field. Includes selection of fields that have dedicated Keys.
	PREV PARAM: Selects previous control field. Includes selection of fields that have dedicated Keys.
	MON: Selects the Surveillance or Broadcast Monitor Screens.
	STORE/RECALL: Selects the Setup-Scenario Data Screen.
	DEDICATED KEYS AND CONTROL FIELDS
	RANGE: RANGE Keys change RANGE.
	RATE: RATE Keys change RATE in 1kt steps (0 to 1200 kts).
	CONTROL FIELDS SOFT KEYS
	STORE/RECALL: Selects Custom, Predefined or User defined scenarios.
	TCAS TYPE: Selections are TCAS I, TCAS II or TAS.
	% REPLY: Selects simulated transponder % reply. Selectable in 1% steps. Range is 0 to 100%.

STEP

PROCEDURE

INTRUDER TYPE:

Selects intruder type MODE S or ATCRBS.

RANGE START:

Selects start range of scenario in nm. Range is Mode S, 0.00 to 260.00 nm or ATCRBS, 0.35 to 260.00.

RANGE STOP:

Selects stop range of scenario in nm. Range is Mode S, 0.00 to 260.00 nm or ATCRBS, 0.35 to 260.00.

RANGE RATE:

Selects range rate of scenario (0 to 1200 kts).

ALT START:

Selects start altitude of scenario in ft. Range is $\pm 127,700$ ft.

NOTE: In all IFR 6000 TCAS scenarios, altitude START and STOP parameters are Relative to UUT altitude, enabling scenarios to be used at any altitude without reprogramming.

ALT STOP:

Selects stop altitude of scenario in ft. Range is $\pm 127,700$ ft.

NOTE: In all IFR 6000 TCAS scenarios, altitude START and STOP parameters are relative to UUT altitude, enabling scenarios to be used at any altitude without reprogramming.

ALT RATE:

Selects altitude rate of scenario in fpm. Range is 0 to 10000 fpm.

CONVERGE:

When converge is ON, altitude rate is automatically calculated to achieve collision at 0 nm and 0 ft (relative to UUT). Range STOP and Alt STOP fields are blanked when converge is ON.

STEP

PROCEDURE

UUT ALT:

Displays simulated intruder altitude in ft. This is either entered via the TCAS Screen or is obtained automatically from the TCAS UUT transponder when ALT DETECT is set to ON.

ALT DETECT:

When set to ON, UUT altitude is obtained automatically from TCAS UUT transponder.

FREQ:

Displays TCAS UUT transmitter frequency in MHz.

ERP:

Displays TCAS UUT transmitter ERP (Effective Radiated Power) in dBm, dBW or W peak.

RANGE:

Displays simulated range in nm.

ALT:

Displays simulated altitude. Depending on setup TCAS menu DISPLAYED ALT setting, altitude displayed is either relative to UUT ALT or actual altitude.

NOTE: In all IFR 6000 TCAS scenarios, altitude START and STOP parameters are relative to UUT altitude, enabling scenarios to be used at any altitude without reprogramming.

TCAS STATUS:

Displays TCAS status either ACQUIRING or TRACKING. When TRACKING is annunciated, an intruder should be displayed on the TCAS display (Mode S feature).

NOTE: ACQUIRING or TRACKING is determined from UF0 or UF16 discrete interrogations AQ field.

STATUS:

Displays simulated test set status in relationship to TCAS UUT. Four different status messages may be displayed.

“NON THREAT”

Range is >4 nm and time until encounter is >40 s.

“PROXIMITY”

Range is [4 nm and time until encounter is >40 sec.

“TRAFFIC”

Time until encounter is [40 sec and >25 sec.

“RESOLUTION”

Time until encounter is [25 sec.

ENCOUNTER:

Displays time in minutes and seconds to encounter.

NOTE: There are usually two to three seconds of delay (target acquisition time) between the start of TCAS operation and when the UUT acquires the test set as a target.

When any UUT antenna is being tested the target acquisition time increases. Refer to Appendix K for target acquisition time probabilities.

5. Press RUN Soft Key to start test.

(Firmware Versions 03.15.01 or later and 04.14.00 or later only)

Note:

The parameters ALT RATE and Altitude Direction can be changed by the user when the scenario is active. This allows the user to manually change the aforementioned parameters to initiate aural advisories from the unit under test. This feature is only available if the CONVERGE parameter is set to OFF.

4.8.5 SETUP-SCENARIO DATA SCREEN

The SETUP-SCENARIO DATA Screen may be accessed from either the TCAS Screen or SETUP-TCAS Screen by pressing the STORE/RECALL Soft Key.

The Setup Scenario Screen allows the recall of nine factory predetermined scenarios and the Storage and Recall of up to 16 user defined and named scenarios.

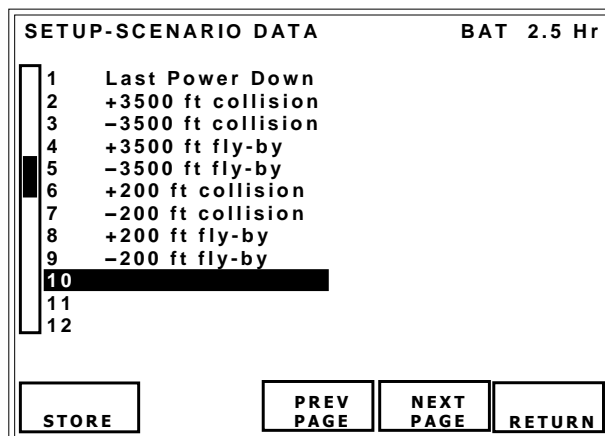

USER CONTROL SOFT KEYS

STORE:

To store a specific scenario, use the Data Select Keys to highlight user storage locations 10 to 25. Press STORE Soft Key to display SETUP-STORE NAME. Use the Data Select Keys to highlight desired character.



CHAR SELECT:

Press CHAR SELECT Soft Key to select character. Repeat until all characters have been selected.

ENTER:

Press ENTER Soft Key to store name and data. Use backspace key to change any previous character selection.

CANCEL:

Press CANCEL Soft Key to cancel storage operation.

RECALL:

To recall a specific scenario use the Data Select Keys to select a specific scenario. Press the RECALL Soft Key.

RETURN:

Press the RETURN Soft Key to display the previous screen.

NOTE: Scenarios are also selected by using the DATA KEYS when in the scenario field of the TCAS screen.

OVERWRITE EXISTING SCENARIO:

To overwrite an existing TCAS scenario, press YES Soft Key on CONFIRM Screen.

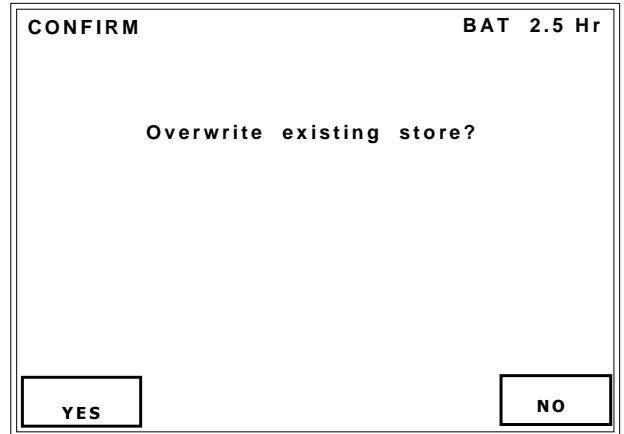

Enter password by pressing the Soft Keys on the SETUP-TCAS SCENARIO Screen.

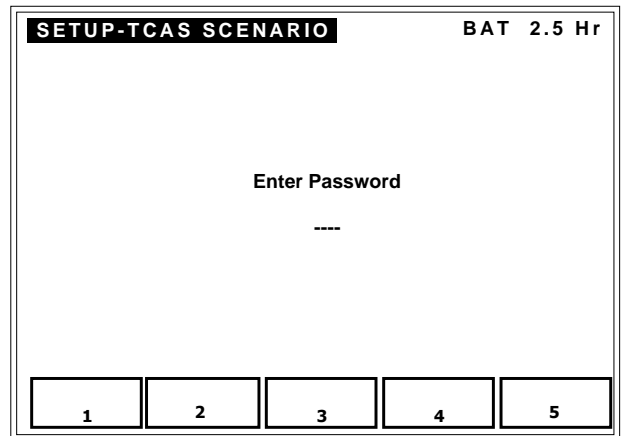

4.8.6 MONITOR SCREENS

Monitor Screens are accessed from the TCAS Screen by pressing the MON Soft Key.

When INTRUDER TYPE selected is Mode S, the Test Set monitors for Uplink Formats (UF) 0 or 16. Mode S monitoring consists of two different Monitor screens; the surveillance monitor and the broadcast monitor.

When INTRUDER TYPE selected is ATRCBS, the Test Set monitors the Whisper-Shout sequence.

4.8.6.1 Surveillance Monitor

The Surveillance Monitor is a general monitoring screen displaying the contents of the major interrogation fields incorporated in UF0 and UF16. Information is displayed in hexadecimal and can be used to verify interrogator bit accuracy.

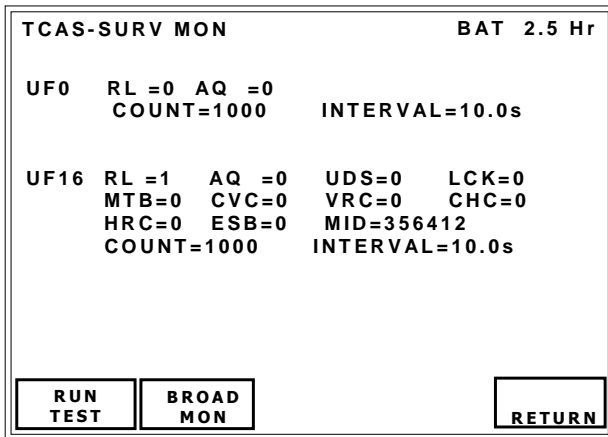

- | STEP | PROCEDURE |
|------|---|
| 1. | Connect UUT to IFR 6000 RF I/O Connector or IFR 6000 Directional Antenna (facing towards UUT Antenna) to Antenna Connector. |
| 2. | Perform the Setup Procedure (para 1-2-4.5.3). Set INTRUDER TYPE: to MODE S . |

- | STEP | PROCEDURE |
|------|---|
| 3. | If UUT simulates altitude and direct connection is not used, shield UUT Antenna being tested with Antenna Shield. Refer to para 1-2-4.6. Position Directional Antenna ≤20 ft (6.1 m) from UUT Antenna being tested. |
| 4. | Press MON Soft Key to enter Surveillance Monitor screen. (Test Set displays information from the last received or recalled Mode S interrogation.) |
| 5. | Press RUN Soft Key to initiate Monitor Mode. (Test Set displays information for the latest received interrogation.) |
- The bottom line indicates running Monitor by displaying: ***Testing***.

Refer to Appendix F for detailed description of the following displayed Uplink Format fields and subfields.

- UF:
- Uplink Format number, as received in the Mode S interrogation, is displayed in decimal form.
- RL:
- Reply Length field, sent in UF0 and UF16, indicates request for transponder (IFR 6000) to reply with DF0 if set to 0 or DF16 if set to 1.
- AQ:
- Acquisition field, sent in UF0 and UF16, indicates request for transponder (IFR 6000) to reply with capability (tracking) report if set to 0 or airspeed (acquisition) report if set to 1.
- UDS:
- The UDS: field, sent in UF16 (part of MU field), defines the content of the MU message field. The UDS: field indicates TCAS Resolution Advisories Lock Requests or Resolution Messages if set to 30 or TCAS Broadcast Messages if set to 32.

STEP **PROCEDURE**

- **LCK:**
If set to 1, the Lock field indicates request for the transponder (IFR 6000) to send information for TCAS Resolution Advisory (transponder is a collision threat to the interrogator) and is received in UF16 (part of MU field).
- **MTB:**
If set to 1 the Multiple Threat Bit received in UF16 (part of MU field) indicates the interrogator is receiving more than one collision threat.
- **CVC:**
The Cancel Vertical Resolution Advisory Complement is received in UF16 (part of MU field) (1-2-4, Table 10).

CVC: FIELD	DEFINITION
0	No cancellation
1	Cancel, don't descend.
2	Cancel, don't climb.

CVC: Field Display Data
Table 10

- **VRC:**
The Vertical Resolution Advisory Complement is received in UF16 (part of MU field) (1-2-4, Table 11).

VRC: FIELD	DEFINITION
0	No complement sent
1	Don't descend.
2	Don't climb.

VRC: Field Display Data
Table 11

STEP **PROCEDURE**

- **CHC:**
The Cancel Horizontal Resolution Advisory Complement is received in UF16 (part of MU field) (1-2-4, Table 12).

CHC: FIELD	DEFINITION
0	No cancellation
1	Cancel, don't turn left.
2	Cancel, don't turn right.

CHC: Field Display Data
Table 12

- **HRC:**
Refer to 1-2-4, Table 13 for the Horizontal Resolution Advisory Complement received in UF16 (part of MU field).

HRC: FIELD	DEFINITION
0	No complement sent
1	Intruder TCAS sense is turn left/Don't turn left.
2	Intruder TCAS sense is turn left/Don't turn right.
5	Intruder TCAS sense is turn right/Don't turn left.
6	Intruder TCAS sense is turn right/Don't turn right.

HRC: Field Display Data
Table 13

STEP PROCEDURE

- ESB:
Refer to 1-2-4, Table **Error!**
Bookmark not defined.4 for the Encoded/Vertical Sense Bits received in UF16 (now VSB, part of MU field) to verify Vertical Resolution Advisory Complements.

CVC: FIELD	VRC: FIELD	VALID ESB: FIELD
0	0	0
0	1	E
0	2	7
0	3	9
1	0	B
1	1	5
1	2	C
1	3	2
2	0	D
2	1	3
2	2	A
2	3	4
3	0	6
3	1	8
3	2	1
3	3	F

ESB: Field Display Data
Table 14

- MID:
The MID: field, received in UF16 (part of MU field) displays the discrete Mode S address of the TCAS interrogator.

STEP PROCEDURE

- INTERVAL:
The IFR 6000 displays time from the start of one interrogation to the start of the next interrogation. The IFR 6000 looks for the interval between 0.53 sec (time to display information) and 1.27 sec (1.0 sec is nominal).
 - COUNT:
The COUNT: field displays the number of TCAS Surveillance Interrogations received during the test operation.
6. Press STOP Soft Key to terminate test operation.

4.8.6.2 BROADCAST MONITOR

The Broadcast Monitor verifies the TCAS Broadcast is transmitted in UF16 approximately every ten seconds. The Test Set detects a TCAS Broadcast when the AA address field decoded from the AP field in UF16 has all ones. The Broadcast Monitor also verifies the RA Broadcast content.

TCAS-BRDCAST MON BAT 2.5 Hr

RA BROADCAST
 UDS=31 CAC=100000 ft
 RAT=1 ARA=11101010000000
 MTE=1 RAC=1010
 AID=7777
 COUNT=1000

TCAS BROADCAST
 UDS=32 MID=A92492
 COUNT=1000 INTERVAL=10.0s

RUN
TEST

SURV
MON

RETURN

STEP PROCEDURE

- **RAC:**
The RAC= field indicates current active Resolution Advisory Complements being received from all other TCAS aircraft with on-board resolution capability (1-2-4, Table 16).

DATA	DEFINITION
0	No resolution advisory complements
1	Don't turn right.
2	Don't turn left.
4	Don't climb.
8	Don't descend.

NOTE: The sum of the Input Data codes indicates multiple active resolution advisories are being received.

RAC= Field Valid Data
Table 16

- **MTE:**
The MTE= field, received in UF16 (part of MU field), indicates if two or more simultaneous threats are currently being processed by the TCAS threat resolution logic. 0= One threat is being processed by the resolution logic (when ARA bit 41=1); or no threat is being processed by the resolution logic (when ARA bit 41=0). 1= Two or more simultaneous threats are being processed by the resolution logic.
- **AID:**
The AID= field, received in UF16 (part of MU field), displays the Mode A identity code of the reporting aircraft.
- **INTERVAL:**
The INTERVAL= field displays the time interval, in seconds, between the latest two TCAS Broadcast Messages received (nominally 10 sec for each interrogator).

STEP PROCEDURE

NOTE: TCAS Broadcast Messages are jittered ±0.2 sec off the nominal 10 sec interval time. The TCAS Broadcast Message may also be staggered between the directional antennas causing shorter intervals, if detected.

- **COUNT:**
The COUNT: field displays the number of TCAS Broadcast Messages received during the test operation.

3. Press STOP Soft Key to terminate test operation.

4.8.6.3 ATCRBS (WHISPER-SHOUT)

The Whisper-Shout Monitor screen provides information used to verify whisper-shout steps and Side Lobe Suppression (SLS). By conducting several tests from different points around the aircraft (para 1-2-4.5.7), the capabilities of the TCAS interrogator concerning coverage (directional and/or omni-directional), whisper-shout sequence operation and interrogation timing are effectively evaluated.

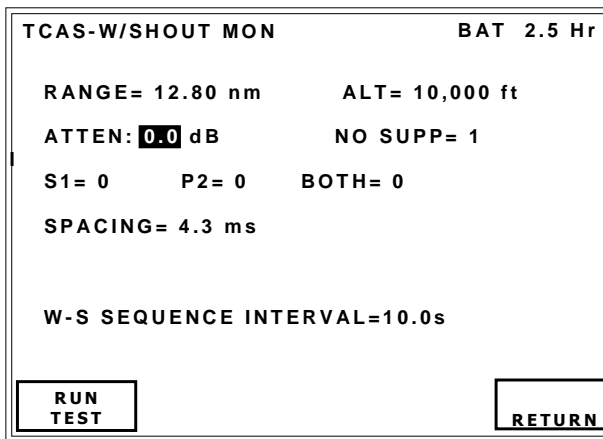

STEP **PROCEDURE**

1. Connect UUT to IFR 6000 RF I/O Connector or IFR 6000 Directional Antenna (facing towards UUT Antenna) to ANT Connector.
 2. Perform the Setup Procedure (para 1-2-4.5.3). Set INTRUDER TYPE: to **ATCRBS**.
 3. If UUT simulates altitude and direct connection is not used, shield UUT Antenna being tested with Antenna Shield. Refer to para 1-2-4.6. Position Directional Antenna ≤ 20 ft (6.1 m) from UUT Antenna being tested.
 4. Press MON Key to enter Whisper-Shout Monitor Screen. The IFR 6000 displays information from the last received or recalled whisper-shout sequence. The latest sequence is displayed if the Test Set is already in the running mode.
 5. Set following parameters by pressing NEXT PARAM and PREV PARAM to select field. Use DATA Keys to slew data.
 - **RANGE:**
The RANGE: field is the same as in TCAS Test (para 1-2-4.5.4).
 - **ALT:**
The ALT: field is the same as the ALT: field in TCAS Test (para 1-2-4.5.4).
 - **ATTEN:**
Set attenuation of incoming signals (UUT interrogations). (The same attenuation is set for outgoing signals [IFR 6000 replies] when Scenario Test or Reply Test functions have been initiated. The IFR 6000 sets a default value internally based upon the UUT distance information entered in XPDR Setup Menu.)
- NOTE:** Attenuation may be changed using the Whisper-Shout Monitor screen. Default value is restored upon exit from the screen.

STEP **PROCEDURE**

6. Press RUN Soft Key to initiate Monitor mode. (The IFR 6000 displays latest whisper-shout sequence information.)
The bottom line indicates running Monitor by displaying ***Testing***.
 - **NO SUPP:**
The IFR 6000 displays the number of processed interrogations, received in latest sequence, without detected S₁ (whisper-shout suppression) and P₂ (SLS) pulses. These interrogations solicit replies.
- NOTE:** If a TCAS Test has been activated, the IFR 6000 sends the number of replies indicated in the NO SUPP: field.
- **S1:**
The IFR 6000 displays the number of processed interrogations, received in latest sequence, containing a detected S₁ pulse, but without a detected P₂ pulse.
- NOTE:** S1: field added with NO SUPP: field provides the number of whisper-shout steps received in latest sequence from the UUT Antenna directed towards the Test Set.
- **P2:**
The IFR 6000 displays the number of interrogations, received in latest sequence containing a detected P₂ pulse, but without a detected S₁ pulse. This information can be used to verify correct SLS operation when the IFR 6000 is positioned between the directional antenna lobes. The P₂: field indicates interrogations not directed towards the Test Set.
 - **BOTH:**
The IFR 6000 displays the number of processed interrogations, received in latest sequence containing both detected S₁ and P₂ pulses. The BOTH: field added to the P₂: field indicates the number of total interrogations not directed towards the Test Set (from the other UUT Antennas).

STEP	PROCEDURE
------	-----------

- **SPACING:**
The IFR 6000 displays the minimum time spacing in ms between any two successive interrogations received in latest sequence.
- **W-S SEQUENCE INTERVAL:**
The IFR 6000 displays time from the start of one whisper-shout sequence to the start of the next whisper-shout sequence. The IFR 6000 looks for the interval between 0.53 sec (time to display information) and 1.27 sec (1.0 sec is nominal).

7. Press STOP Soft Key to terminate test operation.
8. Press RETURN Soft Key to exit Whisper-Shout Monitor Screen

4.8.7 RECOMMENDED TEST PROCEDURE

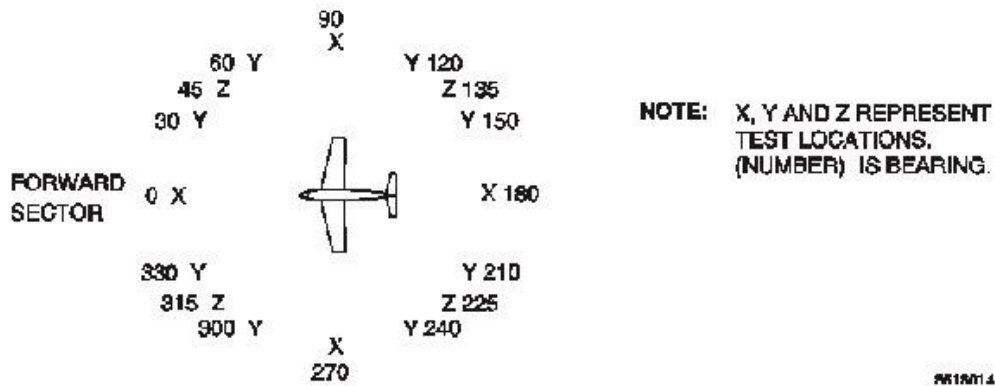

Recommended Test Locations
Figure 9

STEP	PROCEDURE	STEP	PROCEDURE
INITIAL SETUP		9. Press STOP Soft Key to terminate test operation.	
1.	Position Test Set at Forward Sector Test Location (1-2-4, Figure 42) ≤ 50 ft (15.24 m) from and in line of sight with TCAS top antenna.	TCAS SURVEILLANCE OPERATION	
2.	Press SETUP Key. Use NEXT PARAM and PREV PARAM Keys to enter UUT Antenna Range Height and Test Set Directional Antenna information.	10.	Press MON Key to display TCAS Surveillance Monitor Screen.
3.	Press TCAS Mode key to display TCAS Screen.	11.	Press RUN Soft Key to initiate test operation.
4.	Set INTRUDER TYPE: field to MODE S	12.	Verify TCAS Surveillance Interval. INTERVAL: 0.53 to 1.27 sec.
5.	Select SCENARIO: field and slew to (6 +200 ft Collision).	13.	Press STOP Soft Key to terminate test operation.
6.	Set ALT DETECT field to ON.	TCAS BROADCAST OPERATION	
TCAS ADVISORY OPERATION AND BEARING ACCURACY		14.	Press BROAD MON Soft Key to display TCAS Broadcast Monitor screen.
7.	Press RUN Soft Key to initiate test operation.	15.	Press RUN Soft Key to initiate test operation.
8.	Verify UUT visual and audio operation: <ul style="list-style-type: none"> ● Verify Traffic Advisory at 40 sec until encounter time. ● Verify Resolution Advisory at 25 sec until encounter time. ● Verify TCAS bearing reads $0\ \square\ \square\ \square \pm 15^\circ$. 	16.	Verify TCAS Broadcast Interval. INTERVAL: 10 sec (± 0.2 sec) and MID: field contains correct UUT address.
		17.	Press STOP Soft Key to terminate test operation.

STEP PROCEDURE

TCAS OPERATES AT EVERY STEP IN W-S SEQUENCE (Not available in V1.01)

- 18. Press TCAS Mode Key to display TCAS Screen.
- 19. Set INTRUDER TYPE: field to ATCRBS.
- 20. Press MON Key to enter Whisper-Shout Monitor Screen.
- 21. Press RUN Soft Key to initiate test operation.
- 22. Starting at 0.0, slew ATTN: field up in 1.0 dB steps, verifying NO SUPP: field is □1 at each step. Continue until S1: field is 0.
- 23. Press STOP Soft Key to terminate test.

UUT POWER (ERP) AND FREQUENCY

- 24. Press TCAS Mode Key to display TCAS screen.
- 25. Press RUN Soft Key to initiate test operation. Run test for >30 sec.
- 26. Verify power (ERP) = 49.0 dBm (□2 dBm) and frequency (FREQ) = 1030 MHz (□0.01 MHz).
- 27. Press STOP Soft Key to terminate test operation.
- 28. Reposition Test Set To a "Y" Test Location. Stay at same distance from UUT as established in Steps 1 through 2.

TCAS BEARING ACCURACY

- 29. Press TCAS Mode Key to display TCAS Screen.
- 30. Set INTRUDER TYPE: field to **ATCRBS**.
- 31. Press RUN Soft Key to initiate test operation.
- 32. Verify TCAS bearing is correct (□15°).
- 33. Press STOP Soft Key to terminate test operation.
- 34. Reposition Test Set to a "Z" Test Location. Stay at same distance from UUT as established in Steps 1 through 2.

STEP PROCEDURE

SLS PATTERN AT CROSSOVER

- 35. Press MON Soft Key to enter Whisper Shout Monitor Screen.
- 36. Press RUN Soft Key to initiate test operation.
- 37. Verify NO SUPP: field is □2.
- 38. Press STOP Soft Key to terminate test operation.

UUT ANTENNA PATTERN AT CROSSOVER

- 39. Press TCAS Mode Key to display TCAS Screen.
- 40. Press RUN Soft Key to initiate test operation. Run test for >30 sec.
- 41. Verify power (ERP) is □3 dB below the greater ERP of the two adjacent "X" Test Locations.
- 42. Press STOP Soft Key to end test operation.
- 43. Perform Steps 24 through 27 and 29 through 33 from all "X" Test Locations. Stay at same distance from UUT as established in Steps 1 through 5.
- 44. Perform Steps 28 through 33 from all "Y" Test Locations.
- 45. Perform Steps 34 through 42 from all "Z" Test Locations.

NOTE: TCAS II systems do not display RA's unless Radio Altitude is above 500 ft.

NOTE: Ensure aircraft installation is in airborne state.

NOTE: Refer to para 1-2-4.5.1 regarding TCAS II control panels. When simulating an intruder above the aircraft select ABOVE.

4.9 TIS GENERAL DESCRIPTION

Primarily a U.S. deployed system, the Traffic Information Service (TIS) data link provides automatic display of nearby traffic and warns the pilot of potentially threatening traffic conditions. Using the Mode-S data link, a TIS ground processor uplinks surveillance information generated by Mode S sensors to equipped aircraft. The aircraft TIS processor receives the data and displays the data on the TIS display, providing increased situational awareness and an enhanced “see-and-avoid” capability for pilots.

TIS data is obtained from the ground Mode S sensor that acquires and maintains aircraft tracks within its coverage area. TIS can only provide traffic information to aircraft equipped with Mode S, although the system acquires and maintains track information on all aircraft equipped with an ATC Radar Beacon System (ATCRBS). TIS can also integrate primary radar coverage to maintain tracks of non-transponder equipped aircraft. Because it is available to all Mode S transponders, TIS is inexpensive and its availability makes collision avoidance technology more accessible to the price-sensitive general aviation community.

TIS software and Mode S sensors are fielded at a number of terminals nationwide (U.S.) Terminal Mode S installations currently provide 60 nautical mile coverage, including a 5-mile buffer required for TIS coverage.

A Mode S equipped aircraft requests TIS data via a downlink message at 1090 MHz. The ground station sends TIS data to the aircraft via a datalink that operates at 1030 MHz. Data formats for TIS are described in the Minimum Operational Performance Standards for Traffic Information Service (TIS) Data Link Communications RTCA DO-239. The TIS cockpit display provides at least 5 miles of display range and TIS encoding provides values up to seven miles in 1/8-mile intervals. Relative altitudes from -3,000 to +3,500 feet are also accommodated.

4.9.1 TIS MODE

Press the TCAS mode key twice to display the TIS screen.

4.9.2 TIS SETUP

Setup TIS Screen contains parameters which determine operational characteristics of the TIS Functional Mode. Unless otherwise stated, last used values are retained on Power-up.

NOTE: Enter Setup Screen information before conducting test operations.

SETUP-TIS	AVAIL BAT 2.5 Hr
RF PORT: ANTENNA	
ANT RANGE: 12 ft	
ANT HEIGHT: 12 ft	
	ANT GAIN (dBi)
ANT CABLE LEN: 6 ft	1.03 GHz: 7.1
ANT CABLE LOSS: 1.8 dB	1.09 GHz: 6.1
UUT ADDRESS: AUTO	
MANUAL AA: 123456	
PREV PARAM	NEXT PARAM

STEP	PROCEDURE
------	-----------

1. Press SETUP Soft Key to display SETUP TIS Screen.
2. Set the parameters by pressing NEXT PARAM. Press PREV PARAM to select the field. Use DATA Keys to slew the data. Parameters are:
 - RF PORT:
Selects ANTENNA (ANT CONNECTOR) or DIRECT CONNECT via RF I/O Connector.

STEP **PROCEDURE**

- **ANT DIR CPL CABLE LEN:**
Selections: 1 to 75 FT.
- **CABLE LOSS** field is automatically calculated. Cable loss may be manually entered by the user.
- **CABLE LOSS:**
Displays antenna cable loss in dB (at 1090 MHZ). Figure marked on supplied RF coaxial cable
NOTE: Cable loss range 0.0 to 9.9 dB.
If preset length 1, 6, 25, 50 or 60 feet is selected, then cable loss in dB is automatically calculated and displayed.
NOTE: Based on VIAVI supplied cables, (25 and 50 foot cables optional)
NOTE: 25 and 50 foot cable selection compensates for delay of VIAVI optional cables.
- **ANT GAIN:**
Entered in dBi, gain figures for 1030 and 1090 MHz marked on supplied Directional Antenna.
NOTE: Cable loss range 0.0 to 20.9 dB.
- **ANT RANGE:**
Test Set Antenna to transponder antenna horizontal range (6 to 250). Enter parameters for BOTTOM and TOP antenna if installation has diversity capability.
NOTE: UNITS parameter determines feet or meters.

STEP **PROCEDURE**

- **ANT HEIGHT:**
Test Set Antenna Range to transponder antenna height difference (1 to 99).
NOTE: UNITS parameter determines feet or meters.
- **UUT ADDRESS:**
MANUAL or AUTO (defaults to AUTO on power-up). AUTO selection Mode S address is obtained via ATCRBS/Mode S All Call (FAR Part 43, Appendix F approved method).
On loss of ATCRBS/Mode S All Call reply (i.e., UUT placed in ground state) tests already running continue to use last ATCRBS/Mode S All Call obtained address. AUTO uses manually entered address if no reply is received.
NOTE: ICAO amendment 77 transponders only replies to Mode S discrete interrogations when installation is in ground state.
- **MANUAL ADDRESS:**
A six digit HEX address is entered if UUT ADDRESS: MANUAL is selected.

TIS TEST SCREEN

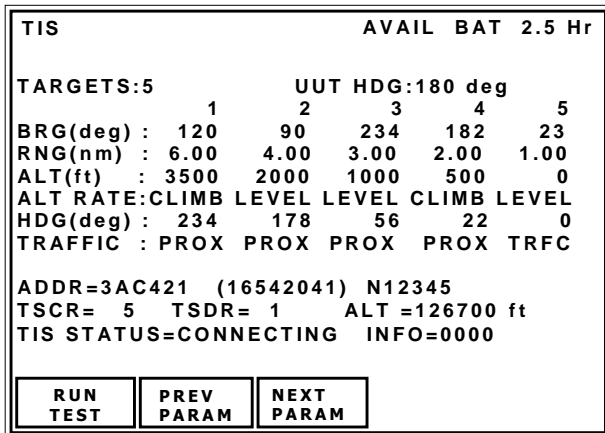

Test Screen Description:

TARGETS: Sets the number of simulated targets 0 to 5.

UUT HDG: Provides entry for UUT Heading in degrees range 0 to 354. This orientates the target bearings with respect to UUT (aircraft) heading.

BRG: Sets target bearing relative to UUT (aircraft) range 0 to 354 degrees

RNG: Sets targets range relative to UUT (aircraft) range 0 to 7 nm

ALT: Sets target altitude relative to UUT (aircraft) range +/- 3500 ft

ALT RATE: Sets Altitude Rate annunciation on TIS display indications: CLIMB, LEVEL, DESCEND, UNUSED.

HDG: Sets target Heading

TRAFFIC: Sets target traffic status on TIS display. PROX (Proximity), TRFC (Traffic)

ADDR= (UUT Aircraft Address) in HEX and (OCTAL)

TSCR= Number of TIS connect requests received

TSDR= Number of TIS disconnect requests received

ALT UUT= UUT Altitude in ft

TIS STATUS: Indications

CONNECTED (Up-linking data to UUTTSCR but not up-linking data to UUT)

INFO= (Debug output of IFR 6000)

- 0x0001 - Reply to Datalink Cap Report
- 0x0002 - No reply to Datalink Cap Report
- 0x0004 - Reply to MSP Cap Report
- 0x0008 - No reply to MSP Cap Report
- 0x0010 - Reply to Broadcast Cap Report
- 0x0020 - No reply to Broadcast Cap Report
- 0x0040 - Reply to keep alive uplink
- 0x0080 - No reply to keep alive uplink
- 0x0100 - Reply to TIS uplink
- 0x0200 - No reply to TIS uplink Reply
- 0x0400 - Reply to lockout
- 0x0800 - No reply to lockout

TIS DISPLAY

The Aircraft heading is shown at the top of the TIS display and the target headings are shown as lines radiating from the target symbols.

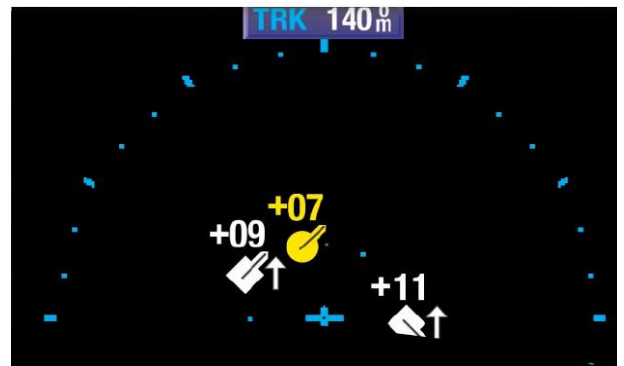

Target status:

White symbol	Proximity
Yellow symbol	Traffic

Relative altitudes are displayed alongside the targets with arrow symbols indicating climbing or descending. The blue cross (bottom center), is the UUT Aircraft.

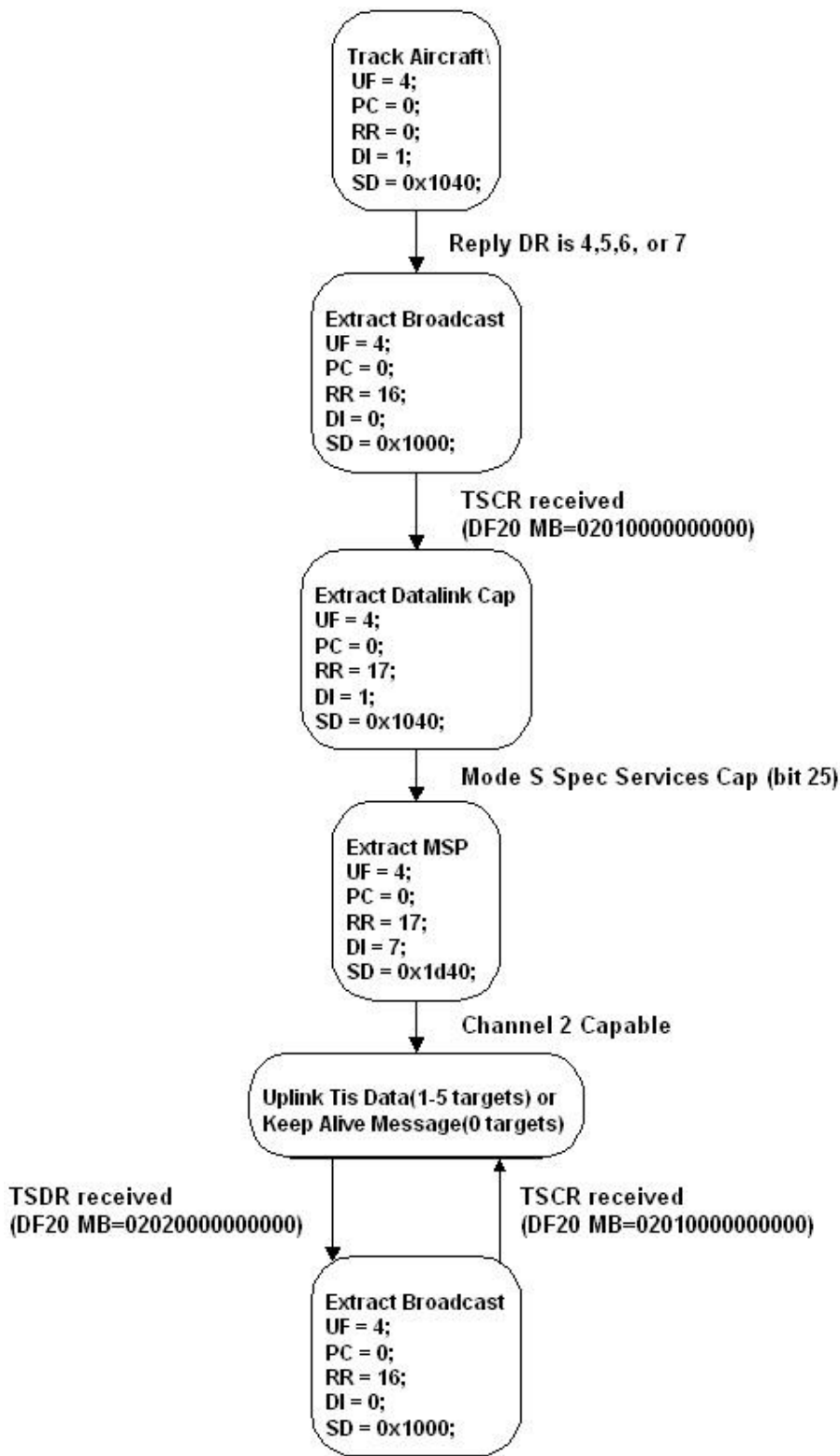

TIS Operation Flow Chart
Figure 1

4.10 DIRECTIONAL ANTENNA USE

The Directional Antenna is used two ways: on the Test Set or Tripod Mounted.



Mount Directional Antenna on friction hinge and connect Directional Antenna ANT Connector to Test Set ANT Connector via 12 in coaxial cable (PN: 62401). If UAT Option is available, connect the short RF coaxial cable (PN: 112831) between the Antenna GPS Connector and the Test Set GPS Connector.



Connect Directional Antenna ANT Connector to the Test Set ANT Connector via 72 in coaxial cable (PN: 112837). If UAT Option is available, connect the 72 in RF coaxial cable (PN: 112830) between the Antenna GPS Connector and the Test Set GPS Connector. The Directional Antenna can be held by hand or mounted on the tripod; point the Directional Antenna at the UUT antenna.

XPDR:

XPDR antennas are top and bottom mounted on the airframe. Verify which antenna(s) is the transponder antenna(s) since the DME antenna(s) look similar.

Position Directional Antenna in direct sight of UUT antenna, avoiding close obstructions (such as gantries, ladders and tool chests etc.), to minimize multi-path reflections which cause random test failures.

Distance for testing top UUT antenna should be sufficient so UUT antenna is visible.

Shield with Antenna Shield (Appendix J) or disconnect and terminate UUT Antenna not being tested. Deactivate other area transponders or position transponders at least three times the XPDR Setup Menu Range from Directional Antenna.

Procedure to Avoid False TCAS RA's on Overflying Aircraft or Altitude:

If the aircraft barometric system is at altitude, shield UUT Antenna being tested with Antenna Shield (Appendix J). Shield with another Antenna Shield or disconnect and terminate UUT Antenna(s) not being tested. Deactivate other area transponders or position transponder >50 ft (15.24 m) from the Directional Antenna. Position Directional Antenna ≤20 ft (6.1 m) from UUT Antenna being tested.

DME:

DME Antennas are bottom mounted on airframe. Verify which antenna(s) is DME Antenna(s) as the transponder lower antenna(s) look similar.

Position Directional Antenna in direct sight of UUT antenna, avoiding close obstructions (such as gantries, ladders and tool chests etc.), to minimize multipath reflections which cause random test failures. Usual distance from UUT antenna is approximately 10 to 20 feet.

NOTE: Directional Antenna should not be positioned closer than 6 feet, to ensure that the antenna far field is tested

TCAS:

Most TCAS installations have top and bottom directional antennas. Some aircraft are fitted with an omni-directional bottom antenna.

Follow Avoid False TCAS RA's on Overflying Aircraft or Altitude procedure.

Position the Test Set Directional Antenna in direct sight of UUT antenna. To minimize intruder bearing error, Test Set antenna should be at the same height as the UUT antenna. Ensure Test Set Directional Antenna is within effective coverage area for either ATRCBS or Mode S.

Avoid close obstructions (such as gantries, ladders and tool chests) to minimize multipath reflections which cause erroneous intruder bearings.

Testing in aircraft hangers may result in erratic bearing of simulated intruder. Changing bearing may result in a more reliable track. When testing top antenna in a hanger use a gantry at the same height as the top antenna.

Due to high power density reduction in some TCAS interrogators, Mode S effective coverage distance may be dependent on the Test Set simulated range. For those units place Test Set according to Simulated Range graph. For simulated ranges within 1 nm, position test set within 30 ft (9.0 m) of UUT antenna.

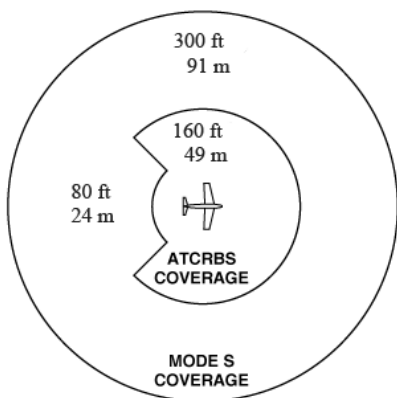
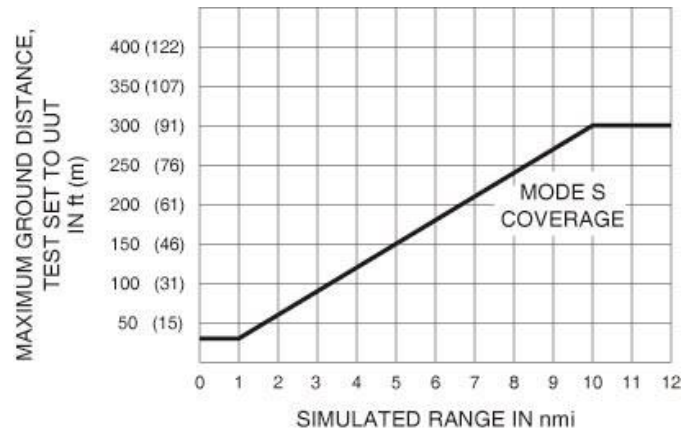

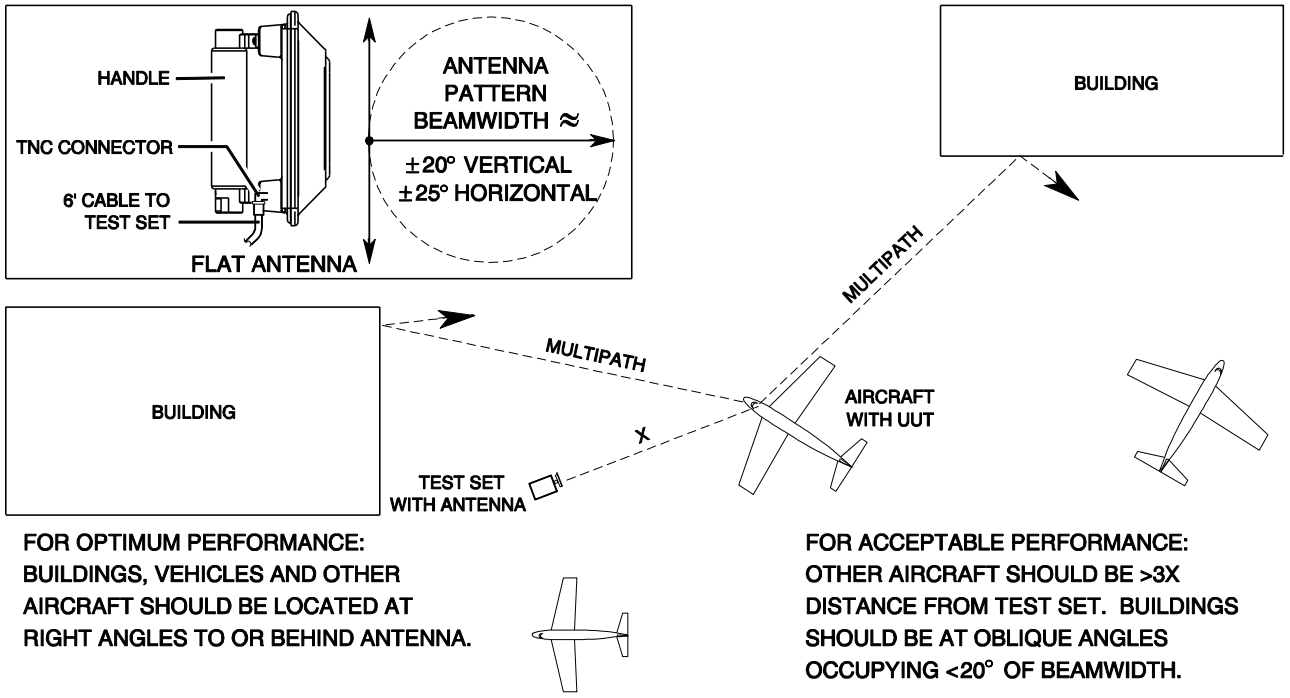

05817A

Suggested Layout to Reduce Multipath Errors
 Figure 11

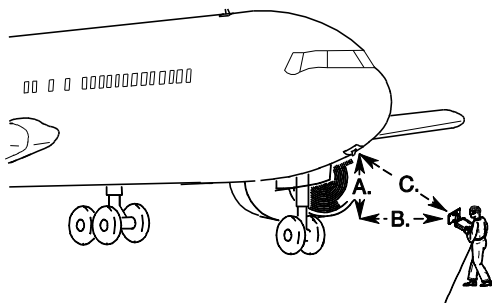
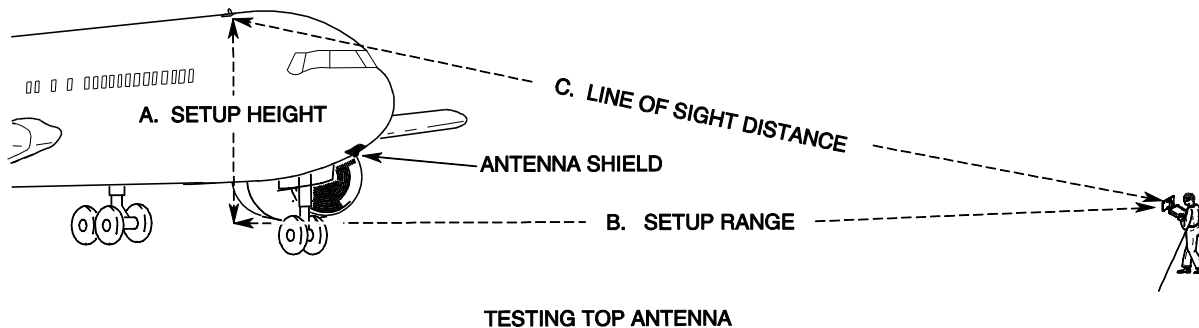

WHEN Deselecting, TERMINATING OR SHIELDING TOP ANTENNA IS NOT POSSIBLE OR PRACTICAL, USE SETUP POSITION THAT HAS AIRCRAFT BLOCKING LINE OF SIGHT TO TOP ANTENNA.

TESTING BOTTOM ANTENNA

05818A

Ramp Testing
Figure 12

4.11 BREAKOUT BOX

The Breakout Box accessory provides access to individual user interfaces via standard connectors. The Test Set REMOTE Connector provides the main user signal interface for the Breakout Box.



THIS PAGE INTENTIONALLY LEFT BLANK.

SECTION 3 - SPECIFICATIONS

NOTE: A 5-minute warm-up period is required for all specifications.

NOTE: Specifications are subject to change without notice.

DME MODE SIGNAL GENERATOR

Output Frequency:

Reply Frequency:

Range: 962 to 1213 MHz

Accuracy: ± 10 kHz

Output Level:

ANT Connector:

Range: -67 to -2 dBm at ANT Connector

Resolution: 1 dB

Accuracy: ± 2 dB

Distance to UUT Antenna: 6 to 300 ft with supplied antenna

RF I/O Connector:

Range: -115 to -47 dBm

Resolution: 1 dB

Accuracy:

-95 to -47 dBm: ± 1 dB

-115 to <-95 dBm: ± 2 dB

Reply Pulse Spacing:

P1 to P2: 12 μ s (± 100 ns) (X Channel) at 50% peak

P1 to P2: 30 μ s (± 100 ns) (Y Channel) at 50% peak

Reply Pulse Width:

P1/P2: 3.5 μ s (± 0.5 μ s)

Echo Reply:

Control: On/Off

Position: 30 nmi (± 1 nmi)

Amplitude: -11 dB (± 1 dB) relative to reply level

DME MODE SIGNAL GENERATOR (cont)

Reply Pulse Rise and Fall Times:

All Pulses:

Rise Time: 2.5 μ s (\pm 0.25 μ s) (10% to 90%)

Fall Time: 2.5 μ s (\pm 0.25 μ s) (90% to 10%)

Reply Delay:

X Channel:

Fixed Reply Delay: 50 μ s (\pm 100 ns)

Y Channel:

Fixed Reply Delay: 56 μ s (\pm 100 ns)

Range Delay:

X and Y Channel:

Range: 0 to 450.00 nmi

Resolution: 0.01 nmi

Accuracy: \pm 0.01 nmi

Range Rate:

X and Y Channel:

Range: 10 to 6500 kts

Resolution: 1 kts

Accuracy: \pm 0.01 % typical, tested to \pm 0.5%

Squitter:

PRF: 2700 Hz

Accuracy: \pm 2%

Distribution: Per ARINC 568

Reply Efficiency:

Range: 0 to 100%

Resolution: 1% increments

Accuracy: \pm 0.5%

Ident Tone:

Selection: Selectable three letter code

Frequency: 1350 Hz

Accuracy: \pm 2 Hz

DME MODE UUT MEASUREMENTS

ERP:

Range: +47 to +64 dBm
Resolution: 0.1 dB
Accuracy: ± 2 dB

Direct Connection Peak Pulse Power:

Range: +47 to +64 dBm
Resolution: 0.1 dB
Accuracy: ± 1 dB

Frequency:

Range: 1025.00 to 1150.00 MHz
Resolution: 10 kHz
Accuracy: ± 20 kHz

Interrogation Pulse Width:

P1 and P2 Pulse Widths:

Range: 2.00 to 5.00 μ s
Resolution: 1 ns
Accuracy: ± 50 ns

Interrogation Pulse Spacing:

P1 to P2 Spacing: 10 to 14 μ s (X Channel)
34 to 38 μ s (Y Channel)
Resolution: 10 ns
Accuracy: ± 20 ns

Interrogation PRF:

Range: 1 to 300 Hz
Resolution: 1 Hz
Accuracy: ± 2 Hz

TRANSPONDER MODE SIGNAL GENERATOR

RF Output Frequency:

Interrogation Frequency: 1030 MHz
Accuracy: ± 10 kHz

RF Output Level:

Ant Connector: MTL +6 dB typical, automatically controlled for a MTL range of -83 to -68 dBm
Range: -67 to -2 dBm at ANT Connector
Resolution: 0.5 dB
Accuracy: ± 2 dB
Distance to UUT Antenna: 6 to 200 ft with supplied antenna
RF I/O Connector: MTL + 6 dB typical, automatically controlled
Range: -115 to -47 dBm
Resolution: 0.5 dB
Accuracy:
-95 to -47 dBm: ± 1 dB
-115 to <-95 dBm: ± 2 dB

ATCRBS/Mode S Interrogation Pulse Spacing:

Mode A:
P1 to P2: 2.00 μ s (± 25 ns)
P1 to P3: 8.00 μ s (± 25 ns)
Mode C:
P1 to P2: 2.00 μ s (± 25 ns)
P1 to P3: 21.00 μ s (± 25 ns)
Mode S:
P1 to P2: 2.00 μ s (± 25 ns)
P1 to P6: 3.50 μ s (± 25 ns)
P1 to SPR: 4.75 μ s (± 25 ns)
P5 to SPR: 0.40 μ s (± 50 ns)

Intermode Interrogation Pulse Spacing:

Mode A:
P1 to P3: 8.00 μ s (± 25 ns)
P1 to P4: 10.00 μ s (± 25 ns)

TRANSPONDER MODE SIGNAL GENERATOR (cont)

Intermode Interrogation Pulse Spacing (cont):

Mode C:

P1 to P3: 21.00 μ s (\pm 25 ns)

P1 to P4: 23.00 μ s (\pm 25 ns)

Interrogation Pulse Widths:

Mode A, C, S, Intermode:

P1, P2, P3: 0.80 μ s (\pm 50 ns)

Mode S:

P6 (Short DPSK Block): 16.25 μ s (\pm 50 ns)

P6 (Long DPSK Block): 30.25 μ s (\pm 50 ns)

P5: 0.80 μ s (\pm 50 ns)

Intermode:

P4 (Short): 0.80 μ s (\pm 50 ns)

P4 (Long): 1.60 μ s (\pm 50 ns)

Interrogation Pulse Rise and Fall Times:

All Modes:

Rise Time: 50 to 100 ns

Fall Time: 50 to 200 ns

Phase Modulation:

All Modes:

Transition Time: \leq 80 ns

Phase Shift: 180° (\pm 10 $^\circ$)

SLS Levels:

ATCRBS:

SLS Level (P2): -9 dB, -1 to +0 dB relative to P1 level
0 dB, -0 to +1 dB relative to P1 level
Off

Mode S:

SLS Level (P5): ^{NOTE 1} -12 dB, -1 to +0 dB relative to P6 level
+3 dB, -0 to +1 dB relative to P6 level
Off

TRANSPONDER MODE SIGNAL GENERATOR (cont)

Interrogation Test Signals:

Mode S:

PRF: 50 Hz (± 5 Hz)

ATCRBS:

PRF: 235 Hz (± 5 Hz)

TRANSPONDER MODE UUT MEASUREMENTS

ERP (at 1090 MHz):

Range: +45.5 to +59 dBm (35.5 to 800 W)
Resolution: 0.1 dB
Accuracy: ± 2 dB

Direct Connection Peak Pulse Power (at 1090 MHz) :

Range: +46.5 to +59 dBm (45 to 800 W)
Resolution: 0.1 dB
Accuracy: ± 1 dB

Transmitter Frequency:

Range: 1087.000 to 1093.000 MHz
Resolution: 10 kHz
Accuracy: ± 50 kHz

Receiver Sensitivity, Radiated MTL:

Range: -79 to -67 dBm into 0 dBi antenna
Resolution: 0.1 dB
Accuracy: ± 2 dB, typical

Receiver Sensitivity, Direct Connection MTL:

Range: -79 to -67 dBm
Resolution: 0.1 dB
Accuracy: ± 2 dB

Reply Delay:

ATCRBS:

Range: 1.80 to 7.00 μ s
Resolution: 10 ns
Accuracy: ± 50 ns

Mode S and ATCRBS Mode S All-Call:

Range: 125.00 to 131.00 μ s
Resolution: 10 ns
Accuracy: ± 50 ns

TRANSPONDER MODE UUT MEASUREMENTS (cont)

Reply Delay Jitter:

ATCRBS:

Range:	0.00 to 2.30 μ s
Resolution:	1 ns
Accuracy:	\pm 20 ns

Mode S and ATCRBS Mode S All-Call:

Range:	0.00 to 6.00 μ s
Resolution:	1 ns
Accuracy:	\pm 20 ns

Pulse Spacing:

F1 to F2:

Range:	19.70 to 21.60 μ s
Resolution:	1 ns
Accuracy:	\pm 20 ns

Mode S Preamble:

Range:

P1 to P2:	0.8 to 1.2 μ s
P1 to P3:	3.3 to 3.7 μ s
P1 to P4:	4.3 to 4.7 μ s

Resolution:	1 ns
Accuracy:	\pm 20 ns

Pulse Widths:

F1 and F2:

Range:	0.25 to 0.75 μ s
Resolution:	1 ns
Accuracy:	\pm 20 ns

Mode S Preamble:

Range:	0.25 to 0.75 μ s
Resolution:	1 ns
Accuracy:	\pm 20 ns

TRANSPONDER MODE UUT MEASUREMENTS (cont)

Pulse Amplitude Variation:

Range:	
Mode S (Relative to P ₁):	-3 to +3 dB
ATCRBS (Relative to F ₁):	-3 to +3 dB
Resolution:	0.1 dB, (0.01 dB via RCI)
Accuracy:	±0.5 dB

DF 11 Squitter Period:

Range:	0.10 to 4.88 sec
Resolution:	10 ms
Accuracy:	±10 ms

Diversity Isolation:

Range:	0 to >20 dB (Depending on Test Distance) Test Distance is 1.83 m (6 ft) to 28.96 m (95 ft)
Resolution:	0.1 dB
Accuracy:	±3 dB

TCAS MODE SIGNAL GENERATOR

Output Frequency:

Reply Frequency: 1090 MHz
Accuracy: ± 10 kHz

Output Level (Simulated ERP) :

ANT Connector: Simulates a 50.5 dBm XPDR ERP at 10 nmi range.
Radiated pwr at 0dBi UUT ant: -68 dBm typical at 10 nmi range, automatically controlled

Range: -67 to -2 dBm at ANT Connector

Resolution: 0.5 dB

Accuracy: ± 2 dB

Distance to UUT Antenna: 6 to 300 ft with supplied antenna

RF I/O Connector:

Automatic mode: -68 dBm at 10 nmi range, automatically controlled

Manual Mode Range -115 to -47 dBm

Resolution: 0.5 dB

Accuracy:

-95 to -47 dBm: ± 1 dB

-115 to <-95 dBm: ± 2 dB

Reply Pulse Spacing:

Mode C:

F1 to F2: 20.30 μ s (± 25 ns)

F1 to C1: 1.45 μ s (± 25 ns)

F1 to A1: 2.90 μ s (± 25 ns)

F1 to C2: 4.35 μ s (± 25 ns)

F1 to A2: 5.80 μ s (± 25 ns)

F1 to C4: 7.25 μ s (± 25 ns)

F1 to A4: 8.70 μ s (± 25 ns)

F1 to B1: 11.60 μ s (± 25 ns)

F1 to D1: 13.05 μ s (± 25 ns)

F1 to B2: 14.50 μ s (± 25 ns)

F1 to D2: 15.95 μ s (± 25 ns)

F1 to B4: 17.40 μ s (± 25 ns)

F1 to D4: 18.85 μ s (± 25 ns)

TCAS MODE SIGNAL GENERATOR (cont)

Reply Pulse Spacing (cont):

Mode S:	
P1 to P2:	1.00 μ s (\pm 25 ns)
P1 to P3:	3.50 μ s (\pm 25 ns)
P1 to P4:	4.50 μ s (\pm 25 ns)
P1 to D1:	8.00 μ s (\pm 25 ns)
D1 to Dn (n = 2 to 112):	1.00 μ s times (n-1) (\pm 25 ns)

Reply Pulse Widths:

Mode C:	
All Pulses:	0.45 μ s (\pm 50 ns)
Mode S:	
P1 through P4:	0.50 μ s (\pm 50 ns)
D1 through D112:	0.50 μ s (\pm 50 ns), 1 μ s chip width
Reply Modes:	TCAS I / II Mode C (with altitude reporting) TCAS II Mode S formats 0, 11, 16

Reply Pulse Amplitudes:

ATCRBS:	\pm 1 dB relative to F1
Mode S:	\pm 1 dB relative to P1

Reply Pulse Rise and Fall Times:

All Modes:	
Rise Time:	50 to 100 ns
Fall Time:	50 to 200 ns

Percent Reply:

Range:	0 to 100%
Resolution:	10%
Accuracy:	\pm 1%

Reply Delay

ATCRBS:	3.0 μ s (\pm 50 ns)
Mode S:	128 μ s (\pm 50 ns)

Range Delay:

Range:	0 to 260 nmi
Resolution:	0.1 nmi
Accuracy:	\pm 0.02 nmi

TCAS MODE SIGNAL GENERATOR (cont)

Range Rate:

Range: -1200 to +1200 kts
Resolution: 10 kts
Accuracy: 10%

Altitude Range:

Range: -1000 to 126,000 ft
Resolution:
Mode C: 100 ft
Mode S: 25 ft

Altitude Rate:

Range: -10,000 to +10,000 fpm
Resolution: 100 fpm
Accuracy: 10%

Squitter:

Control: On/Off
Rate: 0.8 to 1.2 sec, randomly distributed

TCAS MODE UUT MEASUREMENTS

Pulse Spacing:

ATCRBS (Mode C All Call):

S1 to P1:	2.0 us
Accepts:	$\leq \pm 200$ ns
Rejects: (<10% Replies)	$\geq \pm 1.0$ us
P1 to P3:	21.0 us
Accepts:	$\leq \pm 200$ ns
Rejects: (<10% Replies)	$\geq \pm 1.0$ us
P1 to P4:	23.0 us
Accepts:	$\leq \pm 200$ ns
Rejects: (<10% Replies)	$\geq \pm 1.0$ us

Mode S:

P1 to P2:	2.0 us
Accepts:	$\leq \pm 200$ ns
Rejects: (<10% Replies)	$\geq \pm 1.0$ us
P1 to SPR:	4.75 us
Accepts:	$\leq \pm 200$ ns
Rejects: (<10% Replies)	$\geq \pm 1.5$ us

Suppression

ATCRBS (P2 or S1):

>0.5dB above level of P1	<10% Replies
--------------------------	--------------

ERP (at 1030 MHz):

ATCRBS:

Range:	+43 to +58 dBm (20 to 631 W)
Resolution:	0.1 dB
Accuracy:	± 2 dB

Mode S:

Range:	+43 to +58 dBm (20 to 631 W)
Resolution:	0.1 dB
Accuracy:	± 2 dB

Direct Connection Peak Pulse Power (at 1030 MHz):

ATCRBS:

Range:	+43 to +58 dBm (20 to 631 W)
Resolution:	0.1 dB
Accuracy:	± 1 dB

TCAS MODE UUT MEASUREMENTS (cont)

Direct Connection Peak Pulse Power (at 1030 MHz) (cont):

Mode S:

Range: +43 to +58 dBm (20 to 631 W)

Resolution: 0.1 dB

Accuracy: ± 1 dB

Frequency:

Range: 1029.900 to 1030.100 MHz

Resolution: 1 kHz

Accuracy: ± 10 kHz

TCAS Broadcast Interval:

Range: 1.0 to 12.0 sec

Resolution: 0.1 sec

Accuracy: ± 0.2 sec

UAT MODE

RF Signal Generator

Output Frequency

Reply Frequency:

Range: 978 MHz

Accuracy: ± 10 kHz

Output Level

ANT Connector:

-85 dBm, automatically controlled
Radiated power at 0 dBi UUT antenna

Range: -67 to -2 dBm at Antenna port

Resolution: 0.5 dB

Accuracy: ± 2 dB

Distance to UUT Antenna: 6 to 150 ft with Supplied Antenna

RF I/O Connector:

Automatic mode: -85 dBm

Accuracy: ± 1 dB

Modulation

Type: BPFSSK per RTCA DO-282B

Deviation: ± 312.5 kHz typical

UUT Measurements

ERP

Range: +35 to +57 dBm (3.16 to 500 watts)

Resolution: 0.1 dB

Accuracy: ± 2 dB

Direct Connection (@978 MHz)

Range: +35 to +57 dBm (3.16 to 500 watts)

Resolution: 0.1 dB

Accuracy: ± 1 dB

Frequency

Range: 977.96 to 978.04 MHz

Resolution: 1 kHz

Accuracy: ± 10 kHz

MISCELLANEOUS

Inputs/Outputs:

RF I/O:

Type: Input/Output
Impedance: 50 Ω typical
Maximum Input Level: 4 kW peak
10 W average
VSWR: $\leq 1.3:1$

Antenna:

Type: Input/Output
Impedance: 50 Ω typical
Maximum Input Level: 10 W peak
1/2 W average
VSWR: $\leq 1.7:1$

Video

Type: Output
Impedance: 50 Ω typical
Generate Video Level: 0.2 to 1.5 Vpp into 50 Ω
(1030 MHz at -67dBm)
Receive Video Level: Proportional to IF level

Test Antenna:

VSWR: $\leq 1.5:1$, Typical
Gain: 6 dB, Typical

Time Base (TCXO):

Temperature Stability: ± 1 ppm
Aging: ± 1 ppm per year
Accuracy: ± 1 ppm
Test Limit: ± 0.3 ppm

Battery:

Type: Li Ion
Duration: >4 hrs continuous operation
>6 hrs, Typical

Input Power (Test Set):

Input Range: 11 to 32 Vdc
Power Consumption: 55 W Maximum
16 W Nominal at 18 Vdc with charged battery
Fuse Requirements: 5 A, 32 Vdc, Type F

MISCELLANEOUS (cont)

Input Power (Supplied External AC to DC Converter):

Input Range: 100 to 250 VAC, 1.5 A Max, 47 to 63 Hz
Mains Supply Voltage Fluctuations: ≤10% of the nominal voltage
Transient Overvoltages: According to Installation Category II

Environmental (Test Set):

Use: Pollution Degree 2
Altitude: ≤4800 m
Operating Temperature: -20°C to 55°C NOTE 2
Storage Temperature: -30°C to 71°C NOTE 3
Relative Humidity: 95% (±5%) from 5°C to 30°C
75% (±5%) from 30°C to 40°C
45% (±5%) from 40°C to 55°C

Environmental (Supplied External AC to DC Converter):

Use: Indoors
Altitude: ≤10,000 m
Operating Temperature: 0°C to 40°C
Storage Temperature: -20°C to 71°C

Physical Characteristics:

Dimensions:
Height: 11.2 in (28.5 cm)
Width: 9.1 in (23.1 cm)
Depth: 2.7 in (6.9 cm)
Weight (Test Set only): <8 lbs. (3.6 kg)

SUPPLEMENTAL INFORMATION:

Test Set Certifications:

Altitude, Operating:	MIL-PRF-28800F, Class 2
Altitude, Non-Operating:	MIL-PRF-28800F, Class 2
Bench Handling:	MIL-PRF-28800F, Class 2
Blowing Dust	MIL STD -810F, Method 510.4, Procedure 1
Drip Proof:	MIL-PRF-28800F, Class 2
Explosive Atmosphere:	MIL-STD-810F, Method 511.4, Procedure 1
Relative Humidity:	MIL-PRF-28800F, Class 2
Shock, Functional:	MIL-PRF-28800F, Class 2
Vibration Limits:	MIL-PRF-28800F, Class 2
Temperature, Operating:	MIL-PRF-28800F, Class 2 ^{NOTE 4}
Temp, Non-Operating:	MIL-PRF-28800F, Class 2 ^{NOTE 5}
Transit Drop:	MIL-PRF-28800F, Class 2
Safety Compliance:	UL-61010B-1 EN 61010-1 CSA 22.2 No 61010-1
EMC:	EN 61326

External AC-DC Converter Certifications:

Safety Compliance:	UL 1950 DS CSA 22.2 No. 234 VDE EN 60 950
EMI/RFI Compliance:	FCC Docket 20780, Curve "B"
EMC:	EN 61326

Transit Case Certifications:

Drop Test:	FED-STD-101C, Method 5007.1, Paragraph 6.3, Procedure A, Level A
Falling Dart Impact:	ATA 300, Category I
Vibration, Loose Cargo:	FED-STD-101C, Method 5019
Vibration, Sweep:	ATA 300, Category I
Simulated Rainfall:	MIL-STD-810F, Method 506.4, Procedure II of 4.1.2 FED-STD-101C, Method 5009.1, Sec 6.7.1
Immersion:	MIL-STD-810F, Method 512.4

NOTES

- NOTE 1 SLS level is automatically controlled in the SLS LEVEL test.
- NOTE 2 Battery charging temperature range is 5° to 40°C (controlled by internal charger).
- NOTE 3 Li Ion Battery must be removed below -20° C and above 60° C.
- NOTE 4 Temperature range extended to -20°C to 55°C.
- NOTE 5 Temperature range reduced to -30°C to 71°C.

SECTION 4 - SHIPPING

1. SHIPPING TEST SETS

VIAVI Test Sets returned to factory for calibration, service or repair must be repackaged and shipped according to the following conditions:

Authorization

Do not return any products to factory without first receiving authorization from VIAVI Customer Service Department:

- Phone: 1-844-GO-VIAVI
- Email: Techsupport.Avcomm@viavisolutions.com

Tagging Test Sets

All Test Sets must be tagged with:

- Identification and address of owner
- Nature of service or repair required
- Model Number
- Serial Number

Shipping Containers

Test Sets must be repackaged in original shipping containers using VIAVI packing molds. If original shipping containers and materials are not available, contact VIAVI Customer Service for shipping instructions.

Freight Costs

All freight costs on non-warranty shipments are assumed by the customer. (See "Warranty Packet" for freight charge policy on warranty claims.)

Freight Insurance

VIAVI recommends that customers obtain freight insurance with the freight carrier when shipping Test Set. VIAVI is not responsible for cost of repairs for damages that occur during shipment on warranty or non-warranty items. Contact VIAVI Customer Service for Test Set shipping instructions.

NOTE: Test Set must be properly packaged or freight company may not honor insurance claim.

1.2 REPACKING PROCEDURE

- Make sure bottom packing mold is seated on floor of shipping container.
- Carefully wrap Test Set with polyethylene sheeting to protect finish.
- Place Test Set into shipping container, making sure Test Set is securely seated in bottom packing mold.
- Place top packing mold over top of Test Set and press down until top packing mold rests solidly on Test Set.

Close shipping container lids and seal with shipping tape or an industrial stapler. Tie all sides of container with break resistant rope, twine or equivalent.

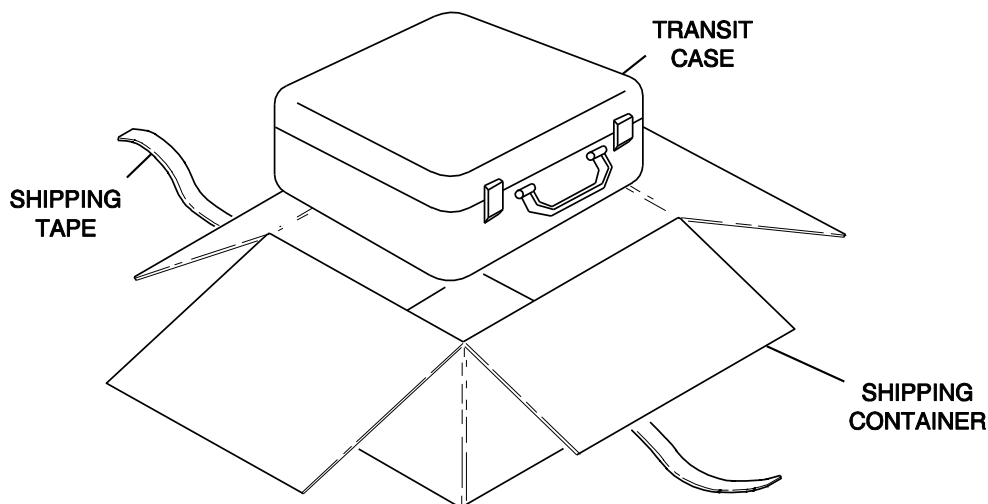

Repacking Procedure
Figure 1

056P-05

SECTION 5 - STORAGE

Perform the following storage precautions whenever the Test Set is stored for extended periods:

- Disconnect Test Set from any electrical power source.
- Disconnect the wire harness connecting the battery to the Test Set and remove the battery. Refer to the Battery/Voltage Instructions.
- Disconnect and store ac power cable and other accessories with Test Set.
- Cover Test Set to prevent dust and debris from covering and entering Test Set.

THIS PAGE INTENTIONALLY LEFT BLANK.

APPENDIX A - CONNECTOR PIN-OUT TABLES

1. I/O CONNECTORS

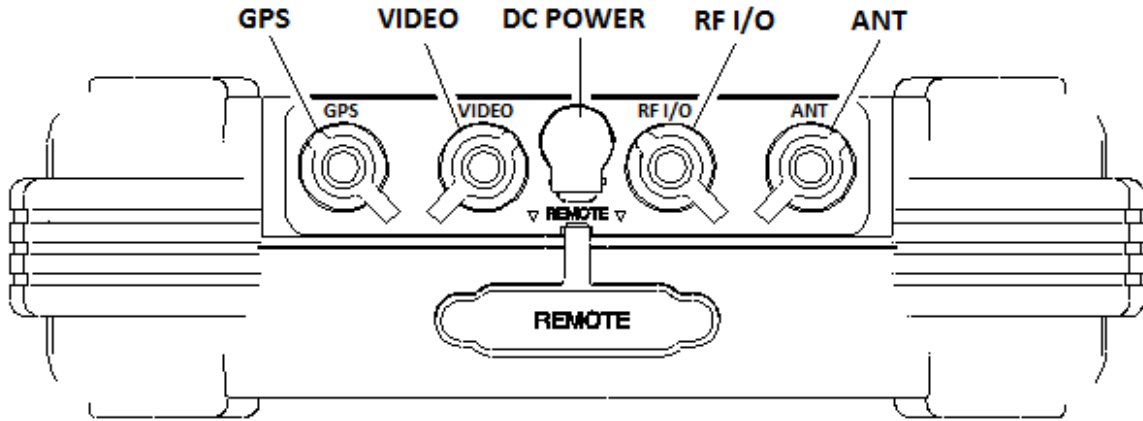

05804

CONNECTOR	TYPE	SIGNAL TYPE	INPUT/OUTPUT
GPS ¹	BNC	RF, 10 dBm MAX	INPUT
VIDEO	BNC	TTL	OUTPUT
DC POWER	2.5 mm CIRCULAR (2.5 mm center, 5.5 mm outer diameter, center positive)	11 to 32 Vdc	INPUT
RF I/O	TNC	RF, 30 W CW MAX	INPUT/OUTPUT
ANT	TNC	RF, 0.5 W CW MAX	INPUT/OUTPUT
REMOTE	44-Pin Female	MIXED	INPUT/OUTPUT
Refer to Appendix A, Table 2 for REMOTE Connector description.			

I/O Connectors
Table 1

¹ If the UAT Option is available, the GPS Connector functions as the GPS Antenna Connector.

2. REMOTE CONNECTOR PIN-OUT TABLE

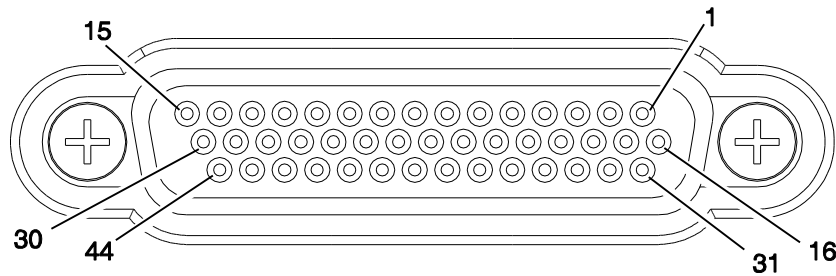

05807

PIN NO.	SIGNAL NAME	SIGNAL TYPE	DESCRIPTION
1	VBUS_DN1	Supply	+5V supply for USB device port
2	GND_DN1	Ground	Ground for USB device port
3	VBUS_UP	Supply	+5V supply input from USB host
4	GND_UP	Ground	Ground for USB host port
5	GND	Ground	System Ground
6	HOST-RTS	Output	RS-232 Request to send
7	A2	Input	Altitude Encode Input
8	A4	Input	Altitude Encode Input
9	C2	Input	Altitude Encode Input
10	C4	Input	Altitude Encode Input
11	GND	Ground	System Ground
12	REM_IN1	Input	General Purpose Input
13	REM_OUT2	Output	General Purpose Output
14	GND	Ground	System Ground
15	GND	Ground	System Ground
16	H_D-	In/Out	USB Host Data Compliment
17	H_D+	In/Out	USB Host Data True
18	D_D-	In/Out	USB Host Data Compliment
19	D_D+	In/Out	USB Host Data True
20	GND	Ground	System Ground
21	HOST_TXD	Output	RS-232 Data Output
22	HOST_CTS	Input	RS-232 Clear to send
23	B1	Input	Altitude Encode Input
24	B2	Input	Altitude Encode Input
25	D2	Input	Altitude Encode Input

REMOTE Connector Pin-Out Table
Table 2

2. REMOTE CONNECTOR PIN-OUT TABLE (cont)

PIN NO.	SIGNAL NAME	SIGNAL TYPE	DESCRIPTION
26	GND	Ground	System Ground
27	REM_IN2	Input	Timestamp Reset LVTTTL Trigger In
28	REM_IN3	Input	General Purpose Input
29	REM_OUT4	Output	General Purpose Output
30	GND	Ground	System Ground
31	VBUS_DN1	Supply	+5V supply for USB device port
32	VBUS_DN1	Supply	+5V supply for USB device port
33	VBUS_UP	Supply	+5V supply input from USB host
34	GND_UP	Ground	Ground for USB host port
35	GND	Ground	System Ground
36	HOST_RXD	Input	RS-232 Data Input
37	A1	Input	Altitude Encode Input
38	B4	Input	Altitude Encode Input
39	C1	Input	Altitude Encode Input
40	REM_SP1		Spare Pin
41	D4	Input	Altitude Encode Input
42	REM_IN4	Input	General Purpose Input
43	REM_OUT1	Output	General Purpose Output
44	REM_OUT3	Output	General Purpose Output

REMOTE Connector Pin-Out Table (cont)
Table 2

THIS PAGE INTENTIONALLY LEFT BLANK.

**APPENDIX B - METRIC/BRITISH IMPERIAL CONVERSION TABLE
WITH NAUTICAL DISTANCE CONVERSIONS**

TO CONVERT:	INTO:	MULTIPLY BY:	TO CONVERT:	INTO:	MULTIPLY BY:
cm	feet	0.03281	meters	feet	3.281
cm	inches	0.3937	meters	inches	39.37
feet	cm	30.48	m/sec	ft/sec	3.281
feet	meters	0.3048	m/sec	km/hr	3.6
ft/sec	km/hr	1.097	m/sec	miles/hr	2.237
ft/sec	knots	0.5921	miles	feet	5280
ft/sec	miles/hr	0.6818	miles	km	1.609
ft/sec ²	cm/sec ²	30.48	miles	meters	1609
ft/sec ²	m/sec ²	0.3048	miles	nmi	0.8684
grams	ounces	0.03527	miles/hr	ft/sec	1.467
inches	cm	2.54	miles/hr	km/hr	1.609
kg	pounds	2.205	miles/hr	knots	0.8684
kg/cm ²	psi	0.0703	nmi	feet	6080.27
km	feet	3281	nmi	km	1.8532
km	miles	0.6214	nmi	meters	1853.2
km	nmi	0.5396	nmi	miles	1.1516
km/hr	ft/sec	0.9113	ounces	grams	28.34953
km/hr	knots	0.5396	pounds	kg	0.4536
km/hr	miles/hr	0.6214	psi	kg/cm ²	0.0703
knots	ft/sec	1.689	100 ft	km	3.048
knots	km/hr	1.8532	100 ft	miles	1.894
knots	miles/hr	1.1516	100 ft	nmi	1.645

THIS PAGE INTENTIONALLY LEFT BLANK.

APPENDIX C - FACTORY/POWER UP PRESETS

Setup General

CONTROL	FACTORY	POWER UP
POWER DOWN	10 mins	Last Used
ERP UNITS	dBm	Last Used
UNITS	Feet	Last Used
REMOTE OPERATION	RS-232	Last Used

Setup XPDR Screen

FIELD	FACTORY	POWER UP
ANTENNA SELECTION	Bottom	Last Used
RF PORT	Antenna	Last Used
ANTENNA RANGE	12 ft	Last Used
ANTENNA HEIGHT	1 ft	Last Used
DIR CABLE LOSS	1.2 dB	Last Used
ANT CABLE	1 ft	Last Used
ANT CABLE LOSS	0.1 dB	Last Used
ANT GAIN 1.03 GHZ	7.1 dB	Last Used
ANT GAIN 1.09 GHZ	6.1 dB	Last Used
UUT ADDRESS	AUTO	AUTO
MANUAL AA	000000	Last Used
DIVERSITY TEST	ON	Last Used
CONFIG TYPE	GENERIC MODE S	Last Used

Setup DME Screen

FIELD	FACTORY	POWER UP
RF PORT	Antenna	Last Used
ANTENNA RANGE	12 ft	Last Used
IDENT TONE	IFR	Last Used
DIR CABLE LOSS	1.2 dB	Last Used
CABLE LOSS	1.3 dB	Last Used
ANT CABLE	1 ft	Last Used
ANT CABLE LOSS	0.1 dB	Last Used
ANT GAIN 0.96 GHZ	7.5 dB	Last Used
ANT GAIN 1.03 GHZ	7.1 dB	Last Used
ANT GAIN 1.09 GHZ	6.1 dB	Last Used
ANT GAIN 1.15 GHZ	5.0 dB	Last Used
ANT GAIN 1.22 GHZ	2.8 dB	Last Used
MAX RANGE	400 nm	Last Used

DME Screen

FIELD	FACTORY	POWER UP
VOR / FREQ / CHAN	978/108.00/17X	978/108.00/17X
RF LVL	Maximum	Maximum
RANGE	0 nm	0 nm
RATE	10 kts	10 kts
RATE DIRECTION	OUT	OUT
% REPLY	100%	100%
ECHO	OFF	OFF
IDENT	ON	ON
SQTR	ON	ON

XPDR Auto Test Screen

FIELD	FACTORY	POWER UP
CONFIG	GENERIC MODE S	Last Used
ANTENNA	Bottom	Last used
LEVEL	Blank	Blank
REPLIES	Blank	Blank
FREQ	Blank	Blank
TOP ERP	Blank	Blank
TOP MTL	Blank	Blank
BOT ERP	Blank	Blank
BOT MTL	Blank	Blank
A CODE	Blank	Blank
C ALT	Blank	Blank
S CODE	Blank	Blank
S ALT	Blank	Blank
TAIL	Blank	Blank
DF17	Blank	Blank
FLIGHT ID	Blank	Blank
AA	Blank	Blank
FS	Blank	Blank
VS	Blank	Blank
COUNTRY	Blank	Blank

TCAS Setup Screen

FIELD	FACTORY	POWER UP
RF PORT	Antenna	Last used
ANT RANGE	12 ft	Last used
ANT HEIGHT	1 ft	Last used
UUT ADDRESS	Auto	Auto
MANUAL AA	000000	Last used
DIR CABLE LOSS	1.2 dB	Last used
ANT CABLE	1 ft	Last used
ANT CABLE LOSS	0.1dB	Last used
ANT GAIN 1.03GHZ	7.1dB	Last used
ANT GAIN 1.09GHZ	6.1dB	Last used
SQUITTERS	ON	Last used
ALT REPORTING	ON	Last used
DISPLAYED ALT	Relative	Last used
TEST SET AA	A92493	Last used

TCAS Screen

FIELD	FACTORY	POWER UP
SCENARIO	0 Custom	0 Custom
TCAS TYPE	TCAS II	TCAS II
REPLY	100%	100%
INTRUDER TYPE	Mode S	Mode S
RANGE START	10.00 nm	10.00 nm
RANGE STOP	0.00 nm	0.00 nm
RANGE RATE	300 kts	300 kts
ALT START	+1000 ft	+1000 ft
ALT STOP	0 ft	0 ft
ALT RATE	500 fpm	500 fpm
CONVERGE	OFF	OFF
UUT ALT	0 ft	0 ft
ALT DETECT	OFF	OFF

ADS-B Setup Screen

FIELD	FACTORY	POWER UP
POS DECODE	Global	Last used
LAT	90 0 0 N	Last used
LONG	180 0 0 E	Last used
ADS-B GEN	DF17	Last used
ADS-B MON	DF17	Last used
GICB	DF20	Last used

ADS-B GEN BDS 0,5 Screen

FIELD	FACTORY	POWER UP
TYPE	9	9
DF	18	Last used
AA	A92492	A92492
PERIOD	1.00 s	1.00 s
LAT	0 0 0 N	0 0 0 N
LONG	0 0 0 E	0 0 0 E
POS	-	-
SAF	0	0
T	N/UTC	N/UTC
SURVEILLANCE STATUS	No info	No info
BARO PRES ALT	0 ft	0 ft
GNSS ALT	-	-

ADS-B GEN BDS 0,6 Screen

FIELD	FACTORY	POWER UP
TYPE	5	5
DF	17	Last used
AA	A92492	A92492
PERIOD	1.00 s	1.00 s
LAT	0 0 0 N	0 0 0 N
LONG	0 0 0 E	0 0 0 E
MOVEMENT	No info	No info
T	N/UTC	N/UTC
HDG	0 deg	0 deg

ADS-B GEN BDS 0,8 Screen

FIELD	FACTORY	POWER UP
TYPE	1	1
DF	18	Last used
COUNT	0	Last used
AA	A92492	A92492
PERIOD	1.00 s	1.00 s
FLIGHT ID	++++++	++++++
EMIT CAT SET	D	D
EMIT CAT	Reserved	Reserved

ADS-B GEN BDS 0,9 Screen

FIELD	FACTORY	POWER UP
TYPE	19	19
DF	17	Last used
AA	A92492	A92492
PERIOD	1.00 s	1.00 s
E-W	0 kts E	0 kts E
NACV	0	0
N-S	0 kts N	0 kts N
HDG	-	-
SUBTYPE	1 – vel ovr gnd norm	1 – vel ovr gnd norm
VERT RATE	0 ft / min	0 ft / min
GEO ALT DIFF FROM BARO	0 ft	0 ft
SOURCE	GEO	GEO
INTENT CHANGE	NO	NO
AIRSPEED	-	-
AIRSPEED TYPE	-	-
IFR CAP ADS-B/CLASS A1>	NO	NO

ADS-B GEN BDS 6,1 Screen

FIELD	FACTORY	POWER UP
TYPE	28	28
DF	18	Last used
AA	A92492	A92492
PERIOD	1.00 s	1.00 s
EMERG / PRIOR CODE	0 – No info	0 – No info
RESERVED	000000000000	000000000000
SUBTYPE	0 – No info	0 – No info

ADS-B GEN BDS 6,2 Screen

FIELD	FACTORY	POWER UP
TYPE	29	29
DF	17	Last used
AA	A92492	A92492
PERIOD	1.00 s	1.00 s
VERT DATA / SOURCE INFO	Not used	Not used
TARG ALT CAP	HLDG ALT	HLDG ALT
VERT MODE IND	Unknown	Unknown
SIL	0	0
TARG ALT TYPE	FL	FL
NIC BARO	0	0
TARG ALT	0 ft	0 ft
TARG HDG	0 deg	0 deg
TCAS/ACAS OPERATIONAL	No	No
RAA	No	No
HORIZ DATA AVAL/ SOURCE IND	Not valid	Not valid
HORIZ MODE IND	Unknown	Unknown
NAC	0	0
EMERG/PRIOR CODE	No Emergency	No Emergency

ADS-B GEN BDS 6,5 Screen

FIELD	FACTORY	POWER UP
TYPE	31	31
DF	18	Last used
AA	A92492	A92492
PERIOD	1.00 s	1.00 s
SUBTYPE	D-airborne	D-airborne
NAC	D	D
BAQ	D	D
SIL	0	0
TC	0	0
CDTI	0	0
ARV	0	0
TS	0	0
RA	0	0
VER NBR	Do-260 / Do-242	Do-260 / Do-242
NOT-TCAS	0	0
OPER MODE SUBFIELD	0	0
NIC BARO	0	0
HORIZ REF DIR	True North	True North
IDENT	No	No
TRK/HDG	-	-
NIC	0	0
LENGTH/WIDTH	-	-
REC ATC SERV	0	0
B2 LOW	-	-
POA	-	-

Setup TIS Screen

FIELD	FACTORY	POWER UP
RF PORT	Antenna	Last used
ANT RANGE	12 ft	Last used
ANT HEIGHT	1 ft	Last used
DIR CABLE LOSS	1.2 dB	Last used
ANT CABLE	1 ft	Last used
ANT CABLE LOSS	0.1 dB	Last used
ANT GAIN 1.03 GHz	7.1	Last used
ANT GAIN 1.09 GHz	6.1	Last used
UUT ADDRESS	Auto	Auto
MANUAL AA	000000	Last used

TIS Screen

FIELD	FACTORY	POWER UP
TARGETS	5	Last used
UUT HDG	0	Last used
BRG (deg) (1-5)	0	Last used
RNG (nm) (1-5)	0	Last used
ALT (ft) (1-5)	0	Last used
ALT RATE	Level	Last used
HDG (1-5)	0	Last used
TRAFFIC (1-5)	Prox	Last used

UAT FIS-B Screen

FIELD	FACTORY	POWER UP
REPORT	METAR	Last used
STN	KICT	Last used
DAY/TIME	Test set Real-time-clock	Last used
DATA	Data linked to STN	Last used
GND LAT	Latitude linked to STN	Last used
LON	Longitude linked to STN	Last used
SLOT ID	0	Last used

Note: The parameters DATA, GND LAT, and LON are slaved to the parameter STN.

UAT TIS-B Screen

FIELD	FACTORY	POWER UP
TARGETS	5	Last used
UUT HDG	0 deg	Last used
BRG	0 deg	Last used
RNG	0 nm	Last used
ALT	0 ft	Last used
HDG	0 deg	Last used
UUT ALT	0 ft	Last used
UUT LAT	0 0 0.00 N	Last used
UUT LON	0 0 0.00 E	Last used
TIS-B SITE ID	0	Last used

UAT ADS-B Screen

FIELD	FACTORY	POWER UP
TARGETS	5	Last used
UUT HDG	0 deg	Last used
BRG	0 deg	Last used
RNG	0 nm	Last used
ALT	0 ft	Last used
HDG	0 deg	Last used
UUT ALT	0 ft	Last used
UUT LAT	0 0 0.00 N	Last used
UUT LON	0 0 0.00 E	Last used

THIS PAGE INTENTIONALLY LEFT BLANK.

APPENDIX D - ABBREVIATIONS

A		C	
A	Amperes	C	Celsius or Centigrade
AA	Address Announced	CA	Transponder Capability
AC	Advisory Circular	CC	Crosslink Capability
AC	Altitude Code	ccw	Counterclockwise
AC	Alternating Current	CDTI	Cockpit Display of Traffic Information
ac	Alternating Current	CFS	Continuation Subfield
ACAS	Airborne Collision Avoidance System	CHAN	Channel
ACS	Comm-A Capability Subfield	CHC	Cancel Horizontal Resolution Advisory
A/D	Analog to Digital	CLOS	Closeout
ADC	Analog to Digital Converter	cm	Centimeter (10 ⁻² Meters)
ADDR	Address	Cont	Continued
ADLP	Airborne Data Link Processor	CPU	Central Processing Unit
ADS	A-Definition Subfield	CrLf	Carriage Return and Line Feed Control
ADS-B	Automatic Dependent Surveillance - Broadcast	CTRL	Control
AGL	Above Ground Level	CTS	Clear to Send/(One-way hardware)
AIS	Comm-A Capability Subfield	CTS/DTR	Two-way hardware
ALT	Altitude	CVC	Cancel Vertical Resolution Advisory Complement
AP	Address Parity	CW	Continuous Wave
AQ	Acquisition Special	cw	Clockwise
ASCII	American National Standard Code for Information Interchange		
ATC	Air Traffic Control	D	
ATC	ATCRBS (screen abbreviation)	D/A	Digital to Analog
ATCRBS	Air Traffic Control Radar Beacon System	DABS	Discrete Address Beacon System
ATE	Automatic Test Equipment	DAC	Digital to Analog Converter
ATTEN	Attenuation	dB	Decibel
AUTO	Automatic	dBi	Decibels above isotropic
AVG	Average	dBm	Decibels above one milliwatt
		dB W/m ²	Decibels above one watt per square meter
B		DCD	Data Carrier Detect
BAT	Battery	DCXO	Digitally Compensated Crystal Oscillator
BCS	Comm-B Capability Subfield	DELM	Downlink Extended Length Message
BD	Comm-B Data	DF	Downlink Format
BDS	B-Definition Subfield	DI	Designator Identification
BIT	Built In Test	DMM	Digital Multimeter
BOT	Bottom	DPSK	Differential Phase Shift Keying
bps	Bits per Second	DR	Downlink Request
BR	Bridge Rectifier	DSP	Digital Signal Processor
BT	Battery	DSR	Data Set Ready
		DTR	Data Terminal Ready

E		L	
ECS	Extended Capability Subfield	LCA	Logic Cell Array
ELM	Extended Length Message	LCD	Liquid Crystal Display
EMC	Electromagnetic Compatibility	LED	Light Emitting Diode
EMI	Electromagnetic Interference	LF	Line Feed
EOL	End of Line	LO	Local Oscillator
ERP	Effective Radiated Power	LOS	Lockout Subfield
ESB	Encoded Sense Bits	LSB	Least Significant Bit
ESD	Electrostatic Discharge	LSD	Least Significant Digit
EXT	External		
F		M	
FCC	Federal Communications Commission	m	Meters
FIS-B	Flight Information Services-Broadcast	MA	Message, COMM-A
FPM	Feet Per Minute	MAX	Maximum
FREQ	Frequency	MB	Message, COMM-B
FS	Flight Status	MBS	Multisite COMM-B Subfield
FT	Foot/Feet	MC	Message, COMM-C
Ft	Foot/Feet	MD	Message, COMM-D
G		ME	Message, COMM-E
GEN	Generator	MEAS	Measuring
GICB	Ground Initiated Comm-B	MES	Multisite ELM Subfield
GND	Ground	MHz	Megahertz (10 ⁶ Hertz)
H		μs	Microsecond (10 ⁻⁶ Seconds)
h	Hexadecimal	MID	Mode S Address
Hz	Hertz	MIN	Minimum
HRC	Horizontal Resolution Advisory Complement	MPU	Microprocessing Unit
I		ms	Millisecond (10 ⁻³ Seconds)
ID	Identification	MTB	Multiple Threat Bit
IDS	Identifier Designators Subfield	MTE	Multiple Threat Encounter
IFF	Identification Friend or Foe	MTL	Minimum Threshold Level
II	Interrogator Identification	MU	Message, COMM-U
IIS	Interrogator Identification Subfield	MV	Message, COMM-V
IN	Input	N	
INTERR	Interrogation	N/A	Not Applicable
I/O	Input/Output	NC	C-Segment Number
ITM	Intermode	ND	D-Segment Number
K		nmi	Nautical Miles
KE	Control, ELM	No	Number
kg	Kilogram (10 ³ Grams)	ns	Nanosecond (10 ⁻⁹ Seconds)
kHz	Kilohertz (10 ³ Hertz)	O	
km	Kilometer (10 ³ meters)	o	Octal
Kts	Knots (Velocity)	OUT	Output
		Ω	Ohm

P		T	
PC	Personal Computer	TAS	Transmission Acknowledgment Subfield
PC	Printed Circuit	TCAS	Traffic Alert and Collision Avoidance System
PC	Protocol	TID	Threat Identity Data
PI	Parity/Interrogator Identity Places	TIS-B	Traffic Information Services - Broadcast
PLCS	Part Number	TMS	Tactical Message Subfield
PN	Pulse Position Modulation	Trig	Trigger
PPM	Parts per Million	TTI	Threat Type Indicator
ppm	Probability of Reply	TTL	Transistor-Transistor Logic
PR	Pulse Repetition Frequency	TX	Transmit
PRF	Programmable Read Only Memory	TXD	Transmit Data
PROM			
psi	Pounds per Square Inch		
PWM	Pulse Width Modulation		
PWR	Power		
R		U	
RAM	Random Access Memory	UAT	Universal Access Transceiver
RAC	Resolution Advisory Complement	UDS	U-Definition Subfield
RAT	Resolution Advisory Termination	UELM	Uplink Extended Length Message
RC	Reply Control	UF	Uplink Format
RCI	Remote Control Interface	UM	Utility Message
RCVD	Received	UTC	Coordinated Universal Time
RCVR	Receiver	UUT	Unit Under Test
Ref	Reference		
RF	Radio Frequency	V	
RI	Reply Information Air-to-Air	V	Volt
RL	Reply Length	VAC	Volts, Alternating Current
RMS	Root Mean Square	VCO	Voltage Controlled Oscillator
ROM	Read Only Memory	Vdc	Volts, Direct Current
RR	Reply Request	VDS	V-Definition Subfield
RRS	Reply Request Subfield	VERS	Version
RSS	Reservation Status Subfield	VRAM	Video Random Access Memory
RTCA	Requirements and Technical Concepts for Aviation organization	VRC	Vertical Resolution Advisory Complement
RTS	Request to Sent	Vrms	Volts Root Mean Square
RX	Receive	VS	Vertical Status
RXD	Receive Data	VSB	Vertical Sense Bits
		VSWR	Voltage Standing Wave Ratio
S		W	
SCOPE	Oscilloscope	W	Watt
SCPI	Standard Commands for Programmable Instruments organization	X	
SD	Special Designator	XMTR	Transmitter
Sec	Second	Xon/Xoff	Software Handshake
SL	Sensitivity Level	XPDR	Transponder
SLM	Standard Length Message		
SLS	Side-Lobe Suppression		
SPI	Special Identifier Pulse		
SQTR	Squitter		
SRQ	Service Request		
SRS	Segment Request Subfield		
SSR	Secondary Surveillance Radar		
SYNC	Synchronous		

THIS PAGE INTENTIONALLY LEFT BLANK.

APPENDIX E - BREAKOUT BOX

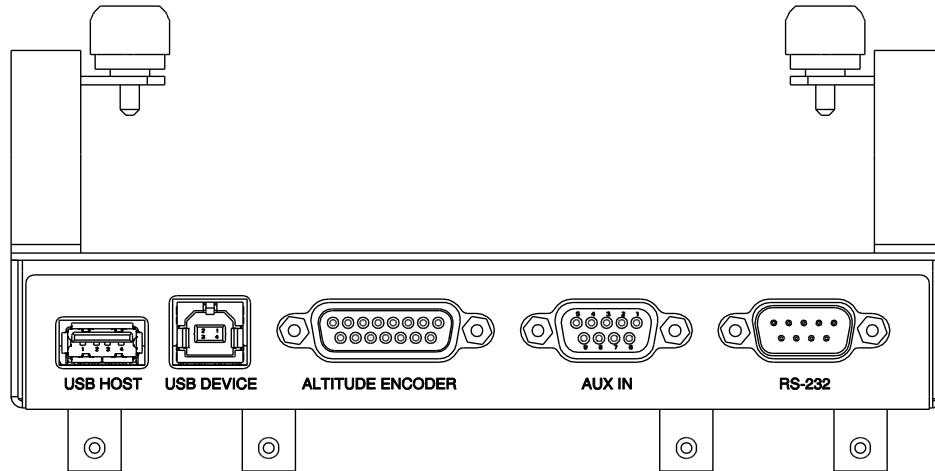

05821

Breakout Box - Top View
Figure 1

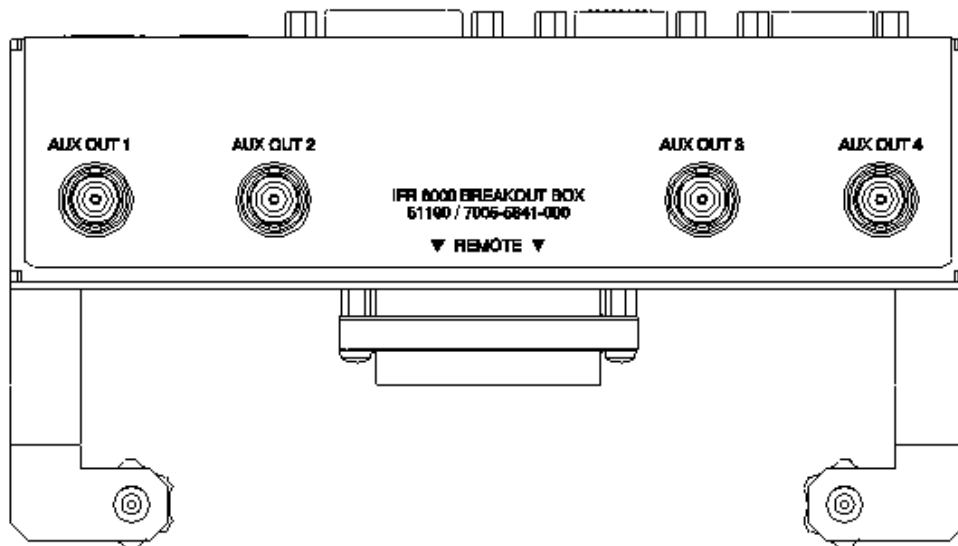

05816

Breakout Box - Front View
Figure 2

1. USB HOST CONNECTOR

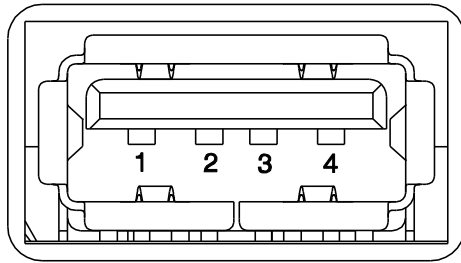

05810

PIN NO.	SIGNAL NAME	SIGNAL TYPE	DESCRIPTION
1	VBUS_DN1	Supply	+5 V supply for USB device port
2	H_D-	In/Out	USB Host Data Compliment
3	H_D+	In/Out	USB Host Data True
4	GND_DN1	Ground	Ground for USB device port

USB HOST Connector Table
Table 1

2. USB DEVICE CONNECTOR

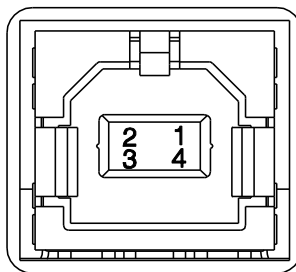

05811

PIN NO.	SIGNAL NAME	SIGNAL TYPE	DESCRIPTION
1	VBUS_UP	Supply	+5 V supply input from USB host
2	D_D-	In/Out	USB Host Data Compliment
3	D_D+	In/Out	USB Host Data True
4	GND_UP	Ground	Ground for USB host port

USB DEVICE Connector Table
Table 2

3. ALTITUDE ENCODER CONNECTOR

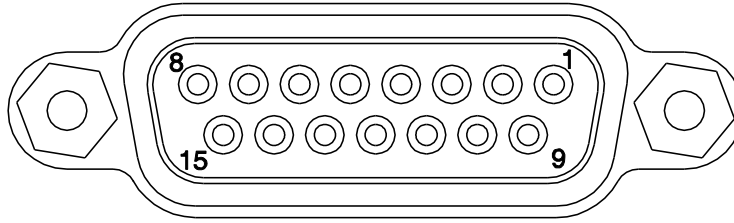

05814

PIN NO.	SIGNAL NAME	SIGNAL TYPE	DESCRIPTION
1	A1	Input	Altitude Encode Input
2	A2	Input	Altitude Encode Input
3	A4	Input	Altitude Encode Input
4	B1	Input	Altitude Encode Input
5	B2	Input	Altitude Encode Input
6	B4	Input	Altitude Encode Input
7	C1	Input	Altitude Encode Input
8	C2	Input	Altitude Encode Input
9	C4	Input	Altitude Encode Input
10			
11	D2	Input	Altitude Encode Input
12	D4	Input	Altitude Encode Input
13	GND	Ground	System Ground
14			
15			

ALTITUDE ENCODER Connector Table
Table 3

4. AUX IN CONNECTOR

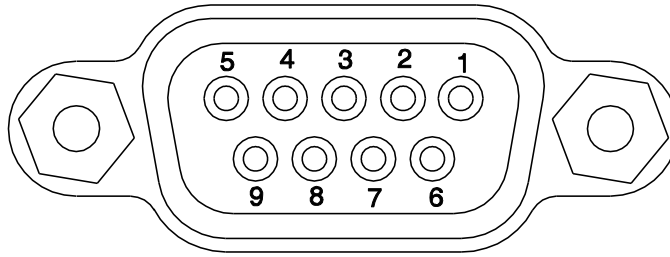

05813

PIN NO.	SIGNAL NAME	SIGNAL TYPE	DESCRIPTION
1	REM_IN1	Input	General Purpose Input
2	REM_IN2	Input	Timestamp Reset LVTTTL Trigger In
3	REM_IN3	Input	General Purpose Input
4	REM_IN4	Input	General Purpose Input
5	GND	Ground	System Ground
6	GND	Ground	System Ground
7	GND	Ground	System Ground
8	GND	Ground	System Ground
9	DNU	Supply	Do Not Use, Reserved

AUX IN Connector Table
Table 4

5. RS-232 CONNECTOR

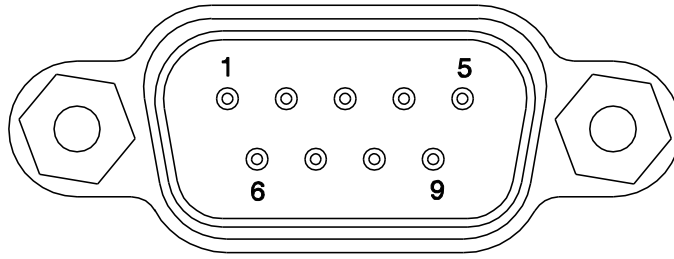

05812

PIN NO.	SIGNAL NAME	SIGNAL TYPE	DESCRIPTION
1			
2	HOST_TXD	BIPOLAR	RS-232 Data Output
3	HOST_RXD	BIPOLAR	RS-232 Data Input
4			
5	GND	Ground	System Ground
6			
7	HOST_CTS	BIPOLAR	RS-232 Clear to Send (Input)
8	HOST_RTS	BIPOLAR	RS-232 Clear to Send (Output)
9			

RS-232 Connector Table
Table 5

6. AUX OUT CONNECTORS



CONNECTOR	SIGNAL TYPE	DESCRIPTION
AUX OUT 1	Output	Mode S Interrogation Trigger
AUX OUT 2	Output	ATCRBS Interrogation Trigger
AUX OUT 3	Output	SYNC ¹
AUX OUT 4	Output	Not Used

Remote OUT Connector Table
Table 6

¹ This is the output of the synchronization pulse of the transmission.

7. REMOTE CONNECTOR

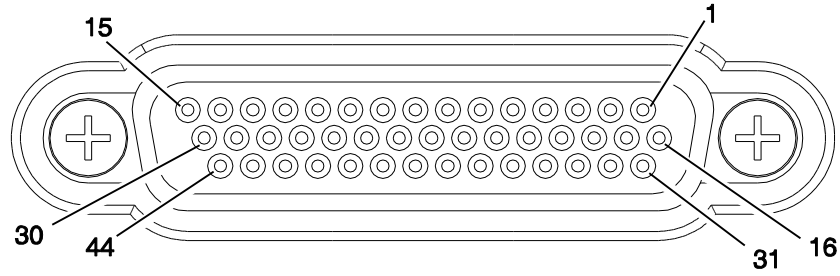

05807

PIN NO.	SIGNAL NAME	SIGNAL TYPE	DESCRIPTION
1	VBUS_DN1	Supply	+5 V supply for USB device port
2	GND_DN1	Ground	Ground for USB device port
3	VBUS_UP	Supply	+5 V supply input from USB host
4	GND_UP	Ground	Ground for USB host port
5	GND	Ground	System Ground
6	HOST-RTS	Output	RS-232 Request to send
7	A2	Input	Altitude Encode Input
8	A4	Input	Altitude Encode Input
9	C2	Input	Altitude Encode Input
10	C4	Input	Altitude Encode Input
11	GND	Ground	System Ground
12	REM_IN1	Input	General Purpose Input
13	REM_OUT2	Output	General Purpose Output
14	GND	Ground	System Ground
15	GND	Ground	System Ground
16	H_D-	In/Out	USB Host Data Compliment
17	H_D+	In/Out	USB Host Data True
18	D_D-	In/Out	USB Host Data Compliment
19	D_D+	In/Out	USB Host Data True
20	GND	Ground	System Ground
21	HOST_TXD	Output	RS-232 Data Output
22	HOST_CTS	Input	RS-232 Clear to send
23	B1	Input	Altitude Encode Input
24	B2	Input	Altitude Encode Input
25	D2	Input	Altitude Encode Input

REMOTE Connector Pin-Out Table
Table 2

7. REMOTE CONNECTOR (cont)

PIN NO.	SIGNAL NAME	SIGNAL TYPE	DESCRIPTION
26	GND	Ground	System Ground
27	REM_IN2	Input	General Purpose Input
28	REM_IN3	Input	General Purpose Input
29	REM_OUT4	Output	General Purpose Output
30	GND	Ground	System Ground
31	VBUS_DN1	Supply	+5 V supply for USB device port
32	VBUS_DN1	Supply	+5 V supply for USB device port
33	VBUS_UP	Supply	+5 V supply input from USB host
34	GND_UP	Ground	Ground for USB host port
35	GND	Ground	System Ground
36	HOST_RXD	Input	RS-232 Data Input
37	A1	Input	Altitude Encode Input
38	B4	Input	Altitude Encode Input
39	C1	Input	Altitude Encode Input
40	REM_SP1		Spare Pin
41	D4	Input	Altitude Encode Input
42	REM_IN4	Input	General Purpose Input
43	REM_OUT1	Output	General Purpose Output
44	REM_OUT3	Output	General Purpose Output

REMOTE Connector Pin-Out Table (cont)
Table 2

APPENDIX F - CONFIGURATIONS

FAR 43

ANT/DIR Configuration	TX Power (dBm)	RX MTL (dBm)	TX Freq (MHz)
GENERIC ATRCBS	48.5 to 57.0	-73 (±4)	1090 (±3)
ATRCBS CLASS A	51.0 to 57.0	-73 (±4)	1090 (±3)
ATRCBS CLASS B	48.5 to 57.0	-73 (±4)	1090 (±3)
GENERIC MODE S	48.5 to 57.0	-74 (±3)	1090 (±3)
MODE S CLASS A	51.0 to 57.0	-74 (±3)	1090 (±1)
MODE S CLASS B	48.5 to 57.0	-74 (±3)	1090 (±3)
MODE S CL B OPT FRQ	48.5 to 57.0	-74 (±3)	1090 (±1)
MODE S CL B OPT POW	51.0 to 57.0	-74 (±3)	1090 (±3)

DIR w/ Coupler Configuration	TX Power (dBm)	RX MTL (dBm)	TX Freq (MHz)
GENERIC ATRCBS	48.5 to 57.0	-66 to -77	1090 (±3)
ATRCBS CLASS A	51.0 to 57.0	-66 to -77	1090 (±3)
ATRCBS CLASS B	48.5 to 57.0	-66 to -77	1090 (±3)
GENERIC MODE S	48.5 to 57.0	-68 to -77	1090 (±3)
MODE S CLASS A	51.0 to 57.0	-68 to -77	1090 (±1)
MODE S CLASS B	48.5 to 57.0	-68 to -77	1090 (±3)
MODE S CL B OPT FRQ	48.5 to 57.0	-68 to -77	1090 (±1)
MODE S CL B OPT POW	51.0 to 57.0	-68 to -77	1090 (±3)

MOD 43

Port Configuration	TX Power (dBm)	RX MTL (dBm)	TX Freq (MHz)
GENERIC ATRCBS	≥48.5	≤-69	1090 (±3)
ATRCBS CLASS A	≥51.0	≤-69	1090 (±3)
ATRCBS CLASS B	≥48.5	≤-69	1090 (±3)
GENERIC MODE S	≥48.5	≤-71	1090 (±3)
MODE S CLASS A	≥51.0	≤-71	1090 (±1)
MODE S CLASS B	≥48.5	≤-71	1090 (±3)
MODE S CL B OPT FRQ	≥48.5	≤ -71	1090 (±1)
MODE S CL B OPT POW	≥51.0	≤-71	1090 (±3)

DIR w/ Coupler Configuration	TX Power (dBm)	RX MTL (dBm)	TX Freq (MHz)
GENERIC ATRCBS	≥48.5	≤-66	1090 (±3)
ATRCBS CLASS A	≥51.0	≤-66	1090 (±3)
ATRCBS CLASS B	≥48.5	≤-66	1090 (±3)
GENERIC MODE S	≥48.5	≤-68	1090 (±3)
MODE S CLASS A	≥51.0	≤-68	1090 (±1)
MODE S CLASS B	≥48.5	≤-68	1090 (±3)
MODE S CL B OPT FRQ	≥48.5	≤-68	1090 (±1)
MODE S CL B OPT POW	≥51.0	≤-68	1090 (±3)

APPENDIX G - MODE S ADDRESS BLOCKS

This table contains Mode S address blocks for countries whose tail numbers are decoded by the IFR 6000. For an expanded list of Mode S codes, refer to Appendix H.

COUNTRY	ADDRESS BLOCK
Belgium	448000 - 448FFF
Canada	C00000 - C3FFFF
Denmark	458000 - 45FFFF
France	380000 - 3AFFFF
Germany	3C0000 - 3FFFFF
Poland	488000 - 48FFFF
Switzerland	4B0000 - 4B7FFF
USA	A00000 - AFFFFFF
Sweden	4A8000 - 4AFFFF
South Korea	718000 - 71FFFF
Australia	7C0000 - 7FFFFFF

THIS PAGE INTENTIONALLY LEFT BLANK.

APPENDIX H - MODE S ADDRESS BLOCKS

This table contains a complete list of Mode S address blocks. For countries whose tail numbers are decoded by the IFR 6000, refer to Appendix G.

COUNTRY	ADDRESS BLOCK
Afghanistan	70000 - 700FFF
Albania	501000 - 5013FF
Algeria	0A0000 - 0A7FFF
Angola	090000 - 090FFF
Antigua and Barbuda	0CA000 - 0CA3FF
Argentina	E00000 - E3FFFF
Armenia	600000 - 6003FF
Australia	7C0000 - 7FFFFF
Austria	440000 - 447FFF
Azerbaijan	600800 - 600BFF
Bahamas	0A8000 - 0A8FFF
Bahrain	894000 - 894FFF
Bangladesh	702000 - 702FFF
Barbados	0AA000 - 0AA3FF
Belarus	510000 - 5103FF
Belgium	448000 - 448FFF
Belize	0AB000 - 0AB3FF
Benin	094000 - 0943FF
Bhutan	680000 - 6803FF
Bolivia	E94000 - E94FFF
Bosnia and Herzegovina	513000 - 5133FF
Botswana	030000 - 0303FF

COUNTRY	ADDRESS BLOCK
Brazil	E40000 - E4FFFF
Brunei Darassalam	895000 - 8953FF
Bulgaria	450000 - 457FFF
Burkin Faso	09C000 - 09CFFF
Burundi	032000 - 032FFF
Cambodia	70E000 - 70EFFF
Cameroon	034000 - 034FFF
Canada	C00000 - C3FFFF
Cape Verde	096000 - 096FF
Central African Republic	06C000 - 06CFFF
Chad	084000 - 084FFF
Chile	E80000 - E80FFF
China	780000 - 78BFFF
Colombia	0AC000 - 0ACFFF
Comoros	035000 - 0353FF
Congo	036000 - 036FFF
Cook Islands	901000 - 9013FF
Costa Rica	0AE000 - 0AEFFF
Côte d'Ivoire	038000 - 038FFF
Croatia	501C00 - 501FFF
Cuba	0B0000 - 0B0FFF
Cyprus	4C8000 - 4C83FF

COUNTRY	ADDRESS BLOCK
Czech Rep	498000 - 49FFFF
Dem Republic Korea	72000 - 727FFF
Dem Republic Congo	08C000 - 08CFFF
Denmark	458000 - 45FFFF
Djibouti	098000 - 0983FF
Dominican Rep	0C4000 - 0C4FFF
Ecuador	E84000 - E84FFF
Egypt	010000 - 017FFF
El Salvador	0B2000 - 0B2FFF
Equatorial Guinea	042000 - 042FFF
Eritrea	202000 - 2023FF
Estonia	511000 - 5113FF
Ethiopia	040000 - 040FFF
Fiji	C88000 - C88FFF
Finland	460000 - 467FFF
France	380000 - 3AFFFF
Gabon	03E000 - 03EFFF
Gambia	09A000 - 09AFFF
Georgia	514000 - 5143FF
Germany	3C0000 - 3FFFFF
Ghana	044000 - 044FFF
Greece	468000 - 46FFFF
Grenada	0C000 - 0CC3FF
Guatemala	0B4000 - 0B4FFF
Guinea	046000 - 046FFF

COUNTRY	ADDRESS BLOCK
Guinea-Bissau	048000 - 0483FF
Guyana	0B6000 - 0B6FFF
Haiti	0B800 - 0B8FFF
Honduras	0BA000 - 0BAFFF
Hungary	470000 - 477FFF
Iceland	4CC000 - 4CCFFF
India	800000 - 83FFFF
Indonesia	8A0000 - 8A7FFF
Iran, Islamic Rep	730000 - 737FFF
Iraq	728000 - 72FFFF
Ireland	4CA000 - 4CAFFF
Israel	738000 - 73FFFF
Italy	300000 - 33FFFF
Jamaica	0BE000 - 0BEFFF
Japan	840000 - 87FFFF
Jordan	740000 - 747FFF
Kazakhstan	683000 - 6733FF
Kenya	04C000 - 04CFFF
Kiribati	C8E000 - C8E3FF
Kuwait	706000 - 706FFF
Kyrgyzstan	601000 - 6013FF
Lao Dem Rep	708000 - 708FFF
Latvia	502C0 - 502FFF
Lebanon	748000 - 74FFFF
Lesotho	04A000 - 04A3FF

COUNTRY	ADDRESS BLOCK
Liberia	050000 - 050FFF
Libyan Arab Jam	018000 - 01FFFF
Lithuania	503C00 - 503FFF
Luxembourg	4D0000 - 4D03FF
Madagascar	054000 - 054FFF
Malawi	057000 - 058FFF
Malaysia	750000 - 757FFF
Maldives	05A000 - 05A3FF
Mali	05C000 - 05CFFF
Malta	4D2000 - 4D23FF
Marshall Islands	900000 - 9003FF
Mauritania	05E000 - 05D3FF
Mauritius	060000 - 0603FF
Mexico	0D0000 - 0D7FFF
Micronesia, Federal States	681000 - 6813FF
Monaco	4D4000 - 4D43FF
Mongolia	682000 - 6823FF
Morocco	020000 - 027FFF
Mozambique	006000 - 006FFF
Myanmar	704000 - 704FFF
Namibia	201000 - 2013FF
Nauru	C8A000 - C8A3FF
Nepal	70A000 - 70AFFF
Netherlands, Kingdom	480000 - 487FFF

COUNTRY	ADDRESS BLOCK
New Zealand	C80000 - C87FFF
Nicaragua	0C0000 - 0C0FFF
Niger	062000 - 062FFF
Nigeria	064000 - 064FFF
Norway	478000 - 47FFFF
Oman	70C000 - 70C3FF
Pakistan	760000 - 767FFF
Palau	684000 - 6843FF
Panama	0C2000 - 0C2FFF
Papua New Guinea	898000 - 898FFF
Paraguay	E88000 - E88FFF
Peru	E8C000 - E8CFFF
Philippines	758000 - 75FFFF
Poland	488000 - 48FFFF
Portugal	490000 - 497FFF
Qatar	06A000 - 06A3FF
Rep of Korea	718000 - 71FFFF
Rep of Moldova	504C00 - 504FFF
Romania	4A0000 - 4A7FFF
Russian Fed	100000 - 1FFFFF
Rwanda	06E000 - 06EFFF
Saint Lucia	C8C000 - C8C3FF
St Vincent and Grenadines	0BC000 - 0BC3FF
Samoa	902000 - 9023FF

COUNTRY	ADDRESS BLOCK
San Marino	500000 - 5003FF
Sao Tome and Principe	09E000 - 09E3FF
Saudi Arabia	710000 - 717FFF
Senegal	070000 - 070FFF
Seychelles	074000 - 0743FF
Sierra Leone	076000 - 0763FF
Singapore	768000 - 76FFFF
Slovakia	505C00 - 505FFF
Slovenia	506C00 - 506FFF
Solomon Islands	897000 - 8973FF
Somalia	078000 - 078FFF
South Africa	008000 - 00FFFF
Spain	340000 - 37FFFF
Sri Lanka	770000 - 777FFF
Sudan	07C000 - 07CFFF
Suriname	0C80000 - 0C8FFF
Swaziland	07A000 - 07A3FF
Sweden	4A8000 - 4AFFFF
Switzerland	4B0000 - 4B7FFF
Syrian Arab Rep	778000 - 77FFFF
Tajikistan	515000 - 5153FF
Thailand	880000 - 887FFF

COUNTRY	ADDRESS BLOCK
The Former Yugoslav Republic of Macedonia	512000 - 5123FF
Togo	08800 - 088FFF
Tonga	C8D000 - C8D3FF
Trinidad and Tobago	0C6000 - 0C6FFF
Tunisia	028000 - 02FFFF
Turkey	4B8000 - 4BFFFF
Turkmenistan	601800 - 601BFF
Uganda	068000 - 068FFF
Ukraine	508000 - 50FFFF
United Arab Emirates	896000 - 896FFF
United Kingdom	400000 - 423FFFF
United Rep of Tanzania	080000 - 080FFF
United States	A00000 - AFFFFF
Uruguay	E90000 - E00FFF
Uzbekistan	507C00 - 507FFF
Vanuatu	C90000 - C903FF
Venezuela	0D8000 - 0DFFFF
Viet Nam	888000 - 88FFFF
Yemen	890000 - 890FFF
Zambia	08A000 - 08AFFF
Zimbabwe	004000 - 0043FF

COUNTRY	ADDRESS BLOCK
Non-Contracting States	
Yugoslavia	4C0000 - 4C7FFF
Other Allocations	
ICAO (1)	F00000 - F07FFF
ICAO (2)	899000 - 8993FF
ICAO (2)	F09000 - F093FF

- (1) ICAO or its designate administers this block for assigning temporary aircraft addresses if and when an immediate action is to be taken to avoid the assignment of an unauthorized 24-bit aircraft address.

It is intended that the temporary address is to be relinquished as soon as practicable when the 24-bit aircraft address is assigned by a Stat of Registry or common mark registering authority in conformance with the provisions in 4, 5 and 6 of the ICAO Annex 10 Vol. III.

The State concerned is then expected to inform ICAO or its designate regarding the release of the temporary address.

- (2) Block allocated for special use in the interest of flight safety

THIS PAGE INTENTIONALLY LEFT BLANK.

APPENDIX I - SIGNAL FORMATS

1. OPERATING GOALS

Mode S combines secondary surveillance radar and a ground-air-ground data link system to provide aircraft surveillance and communications necessary for supporting automated ATC in dense traffic environments. Mode S provides common-channel interoperation with the ATC beacon system and may be implemented over an extended ATRBS-to-Mode S transition period. In supporting ATC automation, Mode S provides the reliable communications necessary for data link services.

2. MODE S MESSAGE CONTENT

2.1 ADDRESS/PARITY (FIELD AP)

All discrete Mode S interrogations (56-bit or 112-bit) and replies (except the All-Call reply) contain the 24-bit discrete address of the Mode S transponder upon which 24 error-detecting parity check bits are overlaid. In the All-Call reply, the 24 parity check bits are overlaid on the address of the Mode S interrogator. The text of the reply includes the discrete address of the transponder.

2.2 SURVEILLANCE

The primary function of Mode S is surveillance. For the Mode S transponder, this function is accomplished by using short (56-bit) transmissions in both directions. In these transmissions, the aircraft reports altitude (DF04) or ATRBS 4096 code as well as flight status (airborne, on the ground, alert, Special Position Identification [SPI], etc.).

2.3 DATA LINK COMMUNICATIONS

The discrete addressing and digital encoding allow Mode S transmissions to be used as digital data links. Interrogation and reply formats of the Mode S system contain sufficient coding space to transmit data. Most Mode S data link transmissions are handled as one 56-bit message included as part of long 112-bit interrogations or replies. The transmissions include the message in addition to surveillance data and is generally used in place of a surveillance interrogation and/or reply.

An efficient transmission of longer messages is accomplished by the extended length message (ELM) capability (UF24 and DF24). Using this capability, a sequence of up to sixteen 80-bit message segments (each with a 112-bit transmission) is transmitted, either ground-to-air or air-to-ground and is acknowledged with a single reply/interrogation. ELMs do not contain surveillance data and thus cannot substitute for a surveillance interrogation-reply cycle.

3. SIGNAL FORMATS

Signal formats for uplink and downlink messages are outlined in Chapter 2, RTCA DO-181 and Chapter 2, Volume I of RTCA DO-185. Tables 1, 2, 3, 4 and 5 in Appendix B contain the signal formats and definitions. Data is expressed in decimal unless otherwise specified. Refer to Appendix B, Table 6 for conversion to hexadecimal, octal or binary. Appendix B, Table 7 shows the ATC-601-2 fixed formats for Mode S using Front Panel operation.

NOTE: TCAS operates in Mode S and many signals pertain only to TCAS.

**FORMAT
NO. UF**

0	(0 0000)	— 3 —(RL:1)— 4 —(AQ:1) (BD:8)— 10 — (AP:24)	Short Air-Air Surveillance
1	(0 0001)	—□□—□□□□□27 or 83 □□□—□□□□(AP:24)	
2	(0 0010)	□□—□□□□□27 or 83 □□—□□□□(AP:24)	
3	(0 0011)	□□□—□□□□□27 or 83 □□—□□□□□(AP:24)	
4	(0 0100)	(PC:3) (RR:5) (DI:3) (SD:16) (AP:24) ..	Surveillance, Altitude Request
5	(0 0101)	(PC:3) (RR:5) (DI:3) (SD:16) (AP:24) ..	Surveillance, Identity Request
6	(0 0110)	□□□—□□□□□27 or 83 □□□—□□□□(AP:24)	
7	(0 0111)	□□□—□□□□□27 or 83 □□□—□□□□(AP:24)	
8	(0 1000)	□□□□—□□□□□27 or 83 □□—□□—□□□(AP:24)	
9	(0 1001)	□□□—□□□□□27 or 83 □□—□□—□□□(AP:24)	
10	(0 1010)	□□□□—□□□□□27 or 83 □□□—□□□□(AP:24)	
11	(0 1011)	(PR:4) (II:4)□□—□□ 19 □□—□□□(AP:24)	Mode S Only All Call
12	(0 1100)	□□□—□□□□□27 or 83 □□□—□□□□(AP:24)	
13	(0 1101)	□□□—□□□□□27 or 83 □□—□□□□□(AP:24)	
14	(0 1110)	□□□—□—□□□□□27 or 83 □□—□□□—□□(AP:24)	
15	(0 1111)	□□□□—□□□□□27 or 83 □□—□□—□□□(AP:24)	
16	(1 0000)	— 3 —(RL:1)— 4 —(AQ:1)□□18 □(MU:56) (AP:24)	Long Air-Air Surveillance
17	(1 0001)	□□□—□□□□□27 or 83 □□—□□□□□(AP:24)	
18	(1 0010)	□□□—□□□□□27 or 83 □□□—□□□□(AP:24)	
19	(1 0011)	□□□—□□□□□27 or 83 □□□—□□□□(AP:24)	
20	(1 0100)	(PC:3) (RR:5) (DI:3) (SD:16) (MA:56) (AP:24)	Comm-A, Altitude Request
21	(1 0101)	(PC:3) (RR:5) (DI:3) (SD:16) (MA:56) (AP:24)	Comm-A, Identity Request
22	(1 0110)	□□□—□□□□□27 or 83 □□□—□□□□(AP:24)	
23	(1 0111)	□□□□—□□□□□27 or 83 □□□—□□□□(AP:24)	
24	(1 1xxx)	(RC:2) (NC:4) (MC:80) (AP:24)	Comm-C (ELM)

- NOTE:** (XX:M) represents a field designated XX containing M number of assigned bits.
- NOTE:** □N□ represents free coding space with N available bits, coded as Zeros for transmission.
- NOTE:** For Uplink Formats (UF) 0 through 23, the format number corresponds to the binary code in the first 5 bits of the interrogation. Format number 24 is arbitrarily defined as the format beginning with Ones in the first two bit positions. The following three bits (xxx) vary with the interrogation content.
- NOTE:** All formats are shown for completeness, although a number of them are unused.

Overview of Mode S Interrogation Formats
Table 1

FORMAT

NO.	DF	
0	(0 0000)	(VS:1) (CC:1)-1-(SL:3)-2-(RI:4)-2-(AC:13) (AP:24).....Short Air-Air Surveillance
1	(0 0001)	□□□□□□□□□□27 or 83 □□□□□□□□ (P:24)
2	(0 0010)	□□□□□□□□□□27 or 83 □□□□□□□□ (P:24)
3	(0 0011)	□□□□□□□□□□27 or 83 □□□□□□□□ (P:24)
4	(0 0100)	(FS:3) (DR:5) (UM:6) (AC:13) (AP:24)..... Surveillance, Altitude Reply
5	(0 0101)	(FS:3) (DR:5) (UM:6) (ID:13) (AP:24)..... Surveillance, Identity Reply
6	(0 0110)	□□□□□□□□□□27 or 83 □□□□□□□□ (P:24)
7	(0 0111)	□□□□□□□□□□27 or 83 □□□□□□□□ (P:24)
8	(0 1000)	□□□□□□□□□□27 or 83 □□□□□□□□ (P:24)
9	(0 1001)	□□□□□□□□□□27 or 83 □□□□□□□□ (P:24)
10	(0 1010)	□□□□□□□□□□27 or 83 □□□□□□□□ (P:24)
11	(0 1011)	(CA:3) (AA:24) (PI:24)..... All Call Reply/Squitter
12	(0 1100)	□□□□□□□□□□27 or 83 □□□□□□□□ (P:24)
13	(0 1101)	□□□□—□□□□27 or 83 □□□□□□□□ (P:24)
14	(0 1110)	□□□□□□□□□□27 or 83 □□□□□□□□ (P:24)
15	(0 1111)	□□□□□□□□□□27 or 83 □□□□□□□□ (P:24)
16	(1 0000)	(VS:1)-2-(SL:3)-2-(RI:4)-2-(AC:13)(MV:56)(AP:24)..... Long Air-Air Surveillance
17	(1 0001)	(CA:3) (AA:24) (ME:56) (PI:24).....Extended Squitter
18	(1 0010)	(CF:3) (AA:24) (ME:56) (PI:24).....Extended Squitter
19	(1 0011)	□□□□□□□□□□27 or 83 □□□□□□□□ (P:24)
20	(1 0100)	(FS:3) (DR:5) (UM:6) (AC:13) (MB:56) (AP:24)..... Comm-B, Altitude Reply
21	(1 0101)	(FS:3) (DR:5) (UM:6) (ID:13) (MB:56) (AP:24)..... Comm-B, Identity Reply
22	(1 0110)	□□□□□□□□□□27 or 83 □□□□□□□□ (P:24)
23	(1 0111)	□□□□□□□□□□27 or 83 □□□□□□□□ (P:24)
24	(1 1xxx)	(KE:1) (ND:4) (MD:80) (AP:24)..... Comm-D (ELM)

- NOTE:** (XX:M) represents a field designated XX containing M number of assigned bits.
- NOTE:** (P:24) represents a 24-bit field reserved for parity information.
- NOTE:** □N□ represents free coding space with N available bits, coded as Zeros for transmission.
- NOTE:** For Downlink Formats (DF) 0 through 23, the format number corresponds to the binary code in the first 5 bits of the reply. Format number 24 is arbitrarily defined as the format beginning with Ones in the first two bit positions. The following three bits (xxx) vary with the reply content.
- NOTE:** All formats are shown for completeness, although a number of them are unused.

Overview Of Mode S Reply Formats
Table 2

FIELD	SUB FIELD	NO. OF BITS	BITS POSITION	FORMATS UP DOWN	CONTENT
AA		24	9-32	X	The aircraft address announced in the clear, used in DF=11, 17.
AC		13	20-32	X	The altitude code used in formats DF=0, 4, 16 and 20. All bits are Zeros if altitude information is not available. Contains metric altitude if M-bit (26) is One.
AP		24 24	33-56 89-112	X	Parity overlaid on the Address appears at the end of all transmissions, uplink and downlink, with the exception of format DF=11.
AQ		1	14	X	Designates formats UF=0, 16 as acquisition transmissions. Bit 14 (RI, DF=0, 16), repeats AQ as received by transponder.
BD		8	15-22	X	Contains the identity of the ground-initiated Comm-B register contents to appear in the MV field of the corresponding reply, used in UF=0.
CA		3	6-8	X	Used in DF=11, Acquisition Squitter & DF17 Extended Squitter or All Call reply, to report transponder capability. Codes are: 0 = Signifies no communications capability (surveillance only,) no ability to set CA code 7, either on the ground or airborne. 1 = Not Used 2 = Not Used 3 = Not Used 4 = Level 2, 3 or 4; ability to set code 7, and is on the ground. 5 = Level 2, 3 or 4; ability to set code 7, and is airborne. 6 = Level 2,3 or 4; ability to set code 7. 7 = DR≠0 or FS=3,4 or 5. NOTE: Codes 1 to 3 were used by earlier Mode S transponders that did not use CA code 7.
CC		1	7	X	Indicates transponder has ability to support crosslink capability (decode the contents of the UF=0 BD field and respond with the contents of the specified ground-initiated Comm-B register in the MV field of the corresponding DF=16 reply. Used in DF=0. 0= Aircraft Cannot Support 1= Aircraft Can Support
CF		3	6-8	X	Used in DF=18, Defines the format of the 112-bit transmission. Codes are: 0 - 1 = ADS-B format 2 - 3 = TIS-B format 4 = TIS-B and ADS-R messages 5 = TIS-B format 6 = ADS-R format 7 = Reserved

Overview of Format Definitions
Table 3

FIELD	SUB FIELD	NO. OF BITS	BITS POSITION	FORMATS UP DOWN	CONTENT
CL		3	14-16	X	Coding in Binary 000=IC Field contains the II code 001=IC Field contains SI codes 1 to 15 010=IC Field contains SI codes 16 to 31 011=IC Field contains SI codes 32 to 47 100=IC Field contains SI codes 48 to 63
DF		5	1-5	X	The first field in all downlink formats is the transmission descriptor.
DI		3	14-16	X	Identifies coding contained in the SD codes are: 0 = SD has Interrogator Identifier (IIS). 1 = SD contains (IIS, MBS, MES, LOS, RSS, TMS). 2 = SD used for extended squitter surface control 3 = SD contains SIS, LSS, RRS 4-6 = Not assigned. 7 = SD contains IIS, RRS, LOS, TMS
DR		5	9-13	X	Requests extraction of downlink messages from the transponder by the interrogator and appears in formats DF=4, 5, 20, 21. The codes are: 0 = No downlink request. 1 = Request to send Comm-B message (B bit set), 2 = TCAS information available. 3 = TCAS information available and request to send Comm-B message. 4 = Comm-B Broadcast #1 available. 5 = Comm-B Broadcast #2 available. 6 = TCAS information and Comm-B Broadcast #1 available. 7 = TCAS information and Comm-B Broadcast #2 available. 8-15 = Not assigned. 16-31 = Request to send n-segments, signified by 15 + n. Codes 1-15 take priority over codes 16-31.

Overview of Format Definitions (cont)
Table 3

FIELD	SUB FIELD	NO. OF BITS	BITS POSITION	FORMATS UP DOWN	CONTENT																																													
FS		3	6-8	X	Reports flight status of aircraft and is used in formats DF=4, 5, 20, 21. Codes are:																																													
					<table border="1"> <thead> <tr> <th>CODE</th> <th>ALERT</th> <th>SPI</th> <th>AIRBORNE</th> <th>ON THE GROUND</th> </tr> </thead> <tbody> <tr> <td>0</td> <td>no</td> <td>no</td> <td>yes</td> <td>no</td> </tr> <tr> <td>1</td> <td>no</td> <td>no</td> <td>no</td> <td>yes</td> </tr> <tr> <td>2</td> <td>yes</td> <td>no</td> <td>yes</td> <td>no</td> </tr> <tr> <td>3</td> <td>yes</td> <td>no</td> <td>no</td> <td>yes</td> </tr> <tr> <td>4</td> <td>yes</td> <td>yes</td> <td colspan="2">either</td> </tr> <tr> <td>5</td> <td>no</td> <td>yes</td> <td colspan="2">either</td> </tr> <tr> <td colspan="5">6 -Reserved</td> </tr> <tr> <td colspan="5">7- Not assigned.</td> </tr> </tbody> </table>	CODE	ALERT	SPI	AIRBORNE	ON THE GROUND	0	no	no	yes	no	1	no	no	no	yes	2	yes	no	yes	no	3	yes	no	no	yes	4	yes	yes	either		5	no	yes	either		6 -Reserved					7- Not assigned.				
CODE	ALERT	SPI	AIRBORNE	ON THE GROUND																																														
0	no	no	yes	no																																														
1	no	no	no	yes																																														
2	yes	no	yes	no																																														
3	yes	no	no	yes																																														
4	yes	yes	either																																															
5	no	yes	either																																															
6 -Reserved																																																		
7- Not assigned.																																																		
ID		13	2-32	X	The 4096 identification code, numbers , as, set by the pilot, in DF=5, 21.																																													
IC		4	10-13	X	<p>Contains II or SI depending on value of CL field.</p> <p>II: Identifies the interrogator and appears in UF=11, the Mode S Only All Call.</p> <p>NOTE: The same information may also appear in the IIS subfields.</p> <p>SI: Surveillance Identifier (lower 4 bits of 6 bit SI code)</p> <p>NOTE: Surveillance Identifier is derived from CL and IC fields of UF11, or directly in the SIS subfield of SD field value of CL field in formats UF4,5,20 and 21</p>																																													
KE		1	4	X	Defines the content of the ND and MD fields in Comm-D replies, DF=24.																																													
MA		56	33-88	X	Messages directed to the aircraft, part of Comm-A interrogations, UF=20, 21.																																													
	ADS	8	33-40	X	Defines the content of the MA message field in Comm-A requests and is expressed in two groups of 4 bits each, ADS1 (33-36) and ADS2 (37-40).																																													
	ADS1	4	33-36	X	Part of the A-Definition Subfield and is set to 0 for TCAS Sensitivity Level Commands.																																													
	ADS2	4	37-40	X	Part of the A-Definition Subfield and is set to 5 for TCAS Sensitivity Level Commands.																																													

Overview of Format Definitions (cont)
Table 3

FIELD	SUB FIELD	NO. OF BITS	BITS POSITION	FORMATS UP DOWN	CONTENT
MA	SLC	4	41-44	X	Sensitivity Level Command for the TCAS aircraft. The codes are: 0 = No command. 1 = Not Assigned. 2 = Select TA_ONLY mode of operation. 3 = Set TCAS Sensitivity Level to 3. 4 = Set TCAS Sensitivity Level to 4. 5 = Set TCAS Sensitivity Level to 5. 6 = Set TCAS Sensitivity Level to 6. 7 = Set TCAS Sensitivity Level to 7. 8-14 = Not Assigned. 15 = Cancel previous Sensitivity Level.
MB		56	33-88	X	Messages to be transmitted to interrogator, part of the Comm-B replies, DF=20, 21. The field contains Data Link, Capability Reports or Aircraft Identification Reports or TCAS Resolution Advisory Reports.
	ACS	20	45-64	X	Comm-A capability subfield reports data link service(s) supported by the installation. If all bits are Zeros, no Comm-A data link services are supported.
	AIS	48	41-88	X	Aircraft Identification, reported when a surveillance or Comm-A interrogation (UF=4, 5, 20, 21) contains RR=18 and DI=anything but 7. AIS contains up to eight 6-bit characters as defined in Table 4.
MB	ARA	14	41-54	X	TCAS Resolution Advisory Report indicating current Active Resolution Advisories (if any) generated by own TCAS unit against one or more threat aircraft. Each bit indicates a specific resolution advisory with One being active and Zero being inactive. Bit indications are: 41-Climb. 42-Don't descend. 43-Don't descend faster than 500 FPM. 44-Don't descend faster than 1000 FPM. 45-Don't descend faster than 2000 FPM. 46-Descend. 47-Don't climb. 48-Don't climb faster than 500 FPM. 49-Don't climb faster than 1000 FPM. 50-Don't climb faster than 2000 FPM. 51-Turn left. 52-Turn right. 53-Don't turn left. 54-Don't turn right.

Overview of Format Definitions (cont)
Table 3

FIELD	SUB FIELD	NO. OF BITS	BITS POSITION	FORMATS UP DOWN	CONTENT
MB	BCS	16	65-80	X	Comm-B capability subfield reports installed data sources that can be accessed by the ground for transmission via a ground-initiated Comm-B. If all bits are Zeros, no data is accessible by a ground-initiated Comm-B.
	BDS	8	33-40	X	Defines the content of the MB message field in reply to ground-initiated Comm-B and is expressed in two groups of 4 bits each, BDS1 (33-36) and BDS2 (37-40).
	BDS1	4	33-36	X	Corresponds with RR in UF=4, 5, 20, 21. The codes are: 0 = MB contains Air-initiated Comm-B. 1 = MB contains Data Link Capability Report. 2 = MB contains Aircraft Identification. 3 = MB contains TCAS Resolution Advisory. 4-15 = Not assigned.
	BDS2	4	37-40	X	Basic report uses BDS2=0. More complex Mode S installations report additional capabilities in various formats assigned to BDS2 codes other than 0 as requested by interrogator, specified in the RRS subfield of SD.
	CFS	4	41-44	X	Continuation subfield contains the BDS2 value of the next additional capability report available from the installation.
MB	ECS	8	81-88	X	Data Link Capability subfield reports ELM capability of installation. No ELM data link services are supported if all bits are Zeros.
	MTE	1	60	X	Multiple Threat Encounter bit indicates ≥ 2 simultaneous TCAS threats.
	RAC	4	55-58	X	Resolution Advisory Complements subfield indicates currently active resolution, advisory complements (if any) received from all other TCAS aircraft with on-board resolution capability. Bits are set to One when active and Zero when inactive. Bit indications are: 55-Don't descend. 56-Don't climb. 57-Don't turn left. 58-Don't turn right.
	RAT	1	59	X	Resolution Advisory Terminated indicator is set to One for 18 seconds (± 1 second) following termination of a previously reported resolution advisory.

Overview of Format Definitions (cont)
Table 3

FIELD	SUB FIELD	NO. OF BITS	BITS POSITION	FORMATS UP DOWN	CONTENT
MB	TID	26	33-88	X	Threat Identity Data subfield contains data according to TTI field. If TTI=1, TID contains Mode S address of threat in bits 63-85 (bits 87-88 are Zero). If TTI=2, TID contains altitude, range and bearing data.
	TIDA	13	63-75	X	Threat Identity Data, Altitude subfield reports Mode C altitude code of the threat.
	TIDB	6	83-88	X	Threat Identity, Bearing subfield reports most recent bearing of the threat.
	TIDR	7	76-82	X	Threat Identity, Range subfield reports most recent range of the threat.
	TTI	2	61-62	X	Threat Type Indicator subfield defines type of data in TID field.
MC		80	9-88	X	Comm-C field contains one segment of a sequence of segments transmitted to the transponder in the ELM mode. MC is part of UF=24.
	IIS	4	9-12 (if RC=0 to 2) or 25-28 (if RC=3)	X	Interrogator Identifier subfield reports the identity of the interrogator (See SD and UM fields).
	SRS	16	9-24	X	If a Comm-C interrogation (UF=24) contains RC=3, the SRS subfield contains a list of segment request-authorizations for DELMs in the 16-bit (9-24) SRS subfield. Starting with bit 9, denoting the first segment, each of the following bits is set to One if the transmission of the corresponding segment is requested. Refer to Table 5.
MD		80	9-88	X	Comm-D field, part of DF=24, contains one segment of a sequence of segments transmitted by the transponder in the ELM mode. It may contain a summary of received MC segments of an uplink ELM.
	TAS	16	17-32	X	Reports segments received in a Comm-C sequence. Starting with bit 17 denoting the first segment, each successive bit is One if the corresponding segment was received. TAS appears if KE=1 in the same reply. Refer to Table 5 for values.
ME		56	33-88	X	Extended squitter message, part of DF=17, contains broadcast messages.
MU		56	33-88	X	Field, part of the long air-air surveillance interrogation UF=16, contains information used in air-to-air exchanges (TCAS, Resolution Messages and TCAS Broadcast Messages).

Overview of Format Definitions (cont)
Table 3

FIELD	SUB FIELD	NO. OF BITS	BITS POSITION	FORMATS UP DOWN	CONTENT
MU	CHC	3	47-49	X	Cancel Horizontal Resolution Advisory Complement. In TCAS Resolution Messages transmitted by TCAS without horizontal resolution capability, CHC is set to 0. The codes are: 0 = No cancellation. 1 = Cancel, don't turn left. 2 = Cancel, don't turn right. 3-7 = Not assigned.
	CVC	2	43-44	X	Cancel Vertical Resolution Advisory Complement. The codes are: 0 = No cancellation. 1 = Cancel, don't descend. 2 = Cancel, don't climb. 3 = Not assigned.
	HRC	3	50-52	X	Horizontal Resolution Advisory Complement. In TCAS Resolution Messages transmitted by TCAS without horizontal resolution capability, HRC is set to 0. The codes are: 0 = No horizontal resolution advisory complement sent. 1 = Intruder TCAS sense is turn left/do not turn left. 2 = Intruder TCAS sense is turn left/do not turn right. 3-4 = Not assigned. 5 = Intruder TCAS sense is turn right/do not turn left. 6 = Intruder TCAS sense is turn right/do not turn right. 7 = Not assigned.
	HSB	5	56-60	X	Encoded Sense Bits for Horizontal Resolution Complements provide a parity coding field protecting the six horizontal sense bits (CHC and HRC) and are used in TCAS III Resolution Messages.
	MID	24	65-88	X	Contains discrete address of interrogating aircraft and is in TCAS Resolution Advisories Lock Requests, TCAS Resolution Messages and TCAS Broadcast Messages. NOTE: TCAS Broadcast Message is sent at 10-second intervals.

Overview of Format Definitions (cont)
Table 3

FIELD	SUB FIELD	NO. OF BITS	BITS POSITION	FORMATS UP DOWN	CONTENT																																																																																																																																								
MU	MTB	1	42	X	Multiple Threat Bit indicates more than one TCAS threat when set to One and no more than one threat when set to Zero.																																																																																																																																								
	UDS	8	33-40	X	Defines the content of the MU message field and is expressed in two 4-bit groups, UDS1 (33-36) and UDS2 (37-40).																																																																																																																																								
	UDS1	4	33-36	X	Is set to 3 for TCAS Resolution Messages and TCAS Broadcast Messages.																																																																																																																																								
	UDS2	4	37-40	X	Is set to 0 for TCAS Resolution Messages or set to 2 for TCAS Broadcast Messages.																																																																																																																																								
	VRC	2	45-46	X	Vertical Resolution Advisory, Complement. The codes are: 0 = No vertical resolution advisory complement sent. 1 = Don't descend. 2 = Don't climb. 3 = Not assigned.																																																																																																																																								
	VSB	4	61-64	X	Encoded Sense Bits for Vertical Resolution Complements provide a parity coding field to protect four vertical sense bits (CVC and VRC) in all TCAS Resolution Messages. If bits 43-46 do not agree with bits 61-64, the TCAS receiver assumes an error and disregards message. Bits are as follows:																																																																																																																																								
					<table border="1"> <thead> <tr> <th>43</th> <th>44</th> <th>45</th> <th>46</th> <th>61</th> <th>62</th> <th>63</th> <th>64</th> </tr> </thead> <tbody> <tr><td>0</td><td>0</td><td>0</td><td>0</td><td>0</td><td>0</td><td>0</td><td>0</td></tr> <tr><td>0</td><td>0</td><td>0</td><td>1</td><td>1</td><td>1</td><td>1</td><td>0</td></tr> <tr><td>0</td><td>0</td><td>1</td><td>0</td><td>0</td><td>1</td><td>1</td><td>1</td></tr> <tr><td>0</td><td>0</td><td>1</td><td>1</td><td>1</td><td>0</td><td>0</td><td>1</td></tr> <tr><td>0</td><td>1</td><td>0</td><td>0</td><td>1</td><td>0</td><td>1</td><td>1</td></tr> <tr><td>0</td><td>1</td><td>0</td><td>1</td><td>0</td><td>1</td><td>0</td><td>1</td></tr> <tr><td>0</td><td>1</td><td>1</td><td>0</td><td>1</td><td>1</td><td>0</td><td>0</td></tr> <tr><td>0</td><td>1</td><td>1</td><td>1</td><td>0</td><td>0</td><td>1</td><td>0</td></tr> <tr><td>1</td><td>0</td><td>0</td><td>0</td><td>1</td><td>1</td><td>0</td><td>1</td></tr> <tr><td>1</td><td>0</td><td>0</td><td>1</td><td>0</td><td>0</td><td>1</td><td>1</td></tr> <tr><td>1</td><td>0</td><td>1</td><td>0</td><td>1</td><td>0</td><td>1</td><td>0</td></tr> <tr><td>1</td><td>0</td><td>1</td><td>1</td><td>0</td><td>1</td><td>0</td><td>0</td></tr> <tr><td>1</td><td>1</td><td>0</td><td>0</td><td>0</td><td>1</td><td>1</td><td>0</td></tr> <tr><td>1</td><td>1</td><td>0</td><td>1</td><td>1</td><td>0</td><td>0</td><td>0</td></tr> <tr><td>1</td><td>1</td><td>1</td><td>0</td><td>0</td><td>0</td><td>0</td><td>1</td></tr> <tr><td>1</td><td>1</td><td>1</td><td>1</td><td>1</td><td>1</td><td>1</td><td>1</td></tr> </tbody> </table>	43	44	45	46	61	62	63	64	0	0	0	0	0	0	0	0	0	0	0	1	1	1	1	0	0	0	1	0	0	1	1	1	0	0	1	1	1	0	0	1	0	1	0	0	1	0	1	1	0	1	0	1	0	1	0	1	0	1	1	0	1	1	0	0	0	1	1	1	0	0	1	0	1	0	0	0	1	1	0	1	1	0	0	1	0	0	1	1	1	0	1	0	1	0	1	0	1	0	1	1	0	1	0	0	1	1	0	0	0	1	1	0	1	1	0	1	1	0	0	0	1	1	1	0	0	0	0	1	1	1	1	1	1	1	1	1
43	44	45	46	61	62	63	64																																																																																																																																						
0	0	0	0	0	0	0	0																																																																																																																																						
0	0	0	1	1	1	1	0																																																																																																																																						
0	0	1	0	0	1	1	1																																																																																																																																						
0	0	1	1	1	0	0	1																																																																																																																																						
0	1	0	0	1	0	1	1																																																																																																																																						
0	1	0	1	0	1	0	1																																																																																																																																						
0	1	1	0	1	1	0	0																																																																																																																																						
0	1	1	1	0	0	1	0																																																																																																																																						
1	0	0	0	1	1	0	1																																																																																																																																						
1	0	0	1	0	0	1	1																																																																																																																																						
1	0	1	0	1	0	1	0																																																																																																																																						
1	0	1	1	0	1	0	0																																																																																																																																						
1	1	0	0	0	1	1	0																																																																																																																																						
1	1	0	1	1	0	0	0																																																																																																																																						
1	1	1	0	0	0	0	1																																																																																																																																						
1	1	1	1	1	1	1	1																																																																																																																																						

Overview of Format Definitions (cont)
Table 3

FIELD	SUB FIELD	NO. OF BITS	BITS POSITION	FORMATS UP DOWN	CONTENT
MV		56	33-88	X	Field, part of the long air-air surveillance reply DF=16, contains information used in air-to-air exchanges (Coordination Reply Message).
	ARA	14	41-54	X	Same as in MB field.
	MTE	1	60	X	Same as in MB field.
	RAC	4	55-58	X	Same as in MB field.
	RAT	1	59	X	Same as in MB field.
MV	VDS	8	33-40	X	Defines the content of the MV message field and is expressed in two 4-bit groups, VDS1 (33-36) and VDS2 (37-40).
	VDS1	4	33-36	X	Is set to 3 for Coordination Reply Message.
	VDS2	4	37-40	X	Is set to 0 for Coordination Reply Message.
NC		4	5-8	X	Provides the segment number transmitted in an uplink ELM and is part of a Comm-C interrogation, UF=24.
ND		4	5-8	X	Provides the segment number transmitted in a downlink ELM and is part of a Comm-D reply, DF=24.
PC		3	6-8	X	Contains operating commands to the transponder and is part of surveillance and Comm-A interrogations UF=4, 5, 20, 21. The codes are: 0 = No changes in transponder state. 1 = Non-selective All Call lockout. 2 = Not assigned. 3 = Not assigned. 4 = Cancel B. 5 = Cancel C. 6 = Cancel D. 7 = Not assigned.
PI		24	33-56	X	Contains the parity overlaid on the interrogator identity code. PI is part of the reply, DF=11, to the Mode S Only All Call.

Overview of Format Definitions (cont)
Table 3

FIELD	SUB FIELD	NO. OF BITS	BITS POSITION	FORMATS UP DOWN	CONTENT
PR		4	6-9	X	<p>Field contains commands to the transponder specifying the reply probability to the Mode S Only All Call interrogation, UF=11 containing the PR. A command to disregard any lockout state can also be given. The assigned codes are:</p> <p>0 = Reply with probability = 1. 1 = Reply with probability = 1/2. 2 = Reply with probability = 1/4. 3 = Reply with probability = 1/8. 4 = Reply with probability = 1/16. 5,6,7 = Do not Reply. 8 = Disregard lockout, reply with probability = 1. 9 = Disregard lockout, reply with probability = 1/2. 10 = Disregard lockout, reply with, probability = 1/4. 11 = Disregard lockout, reply with probability = 1/8. 12 = Disregard lockout, reply with probability = 1/16. 13, 14, 15 = Do not reply.</p> <p>NOTE: On receipt of a Mode S Only All Call containing a PR code other than 0 or 8, transponder executes a random process and makes a reply decision for the interrogation in accordance with the commanded probability. Random occurrence of replies enables interrogator to acquire closely spaced aircraft when replies would otherwise synchronously garble each other.</p>
RC		2	3-4	X	<p>Designates transmitted segment as initial, intermediate or final if coded 0, 1 or 2 respectively. RC=3 is used to request Comm-D DELMs by the transponder. RC is part of Comm-C interrogation, UF=24.</p>

Overview of Format Definitions (cont)
Table 3

FIELD	SUB FIELD	NO. OF BITS	BITS POSITION	FORMATS UP DOWN	CONTENT																					
RI		4	14-17	X	Information in DF=0, 16. The codes are: 0 = No on-board TCAS. 1 = Not assigned. 2 = On-board TCAS with resolution capability inhibited. 3 = On-board TCAS with vertical-only resolution capability. 4 = On-board TCAS with vertical and horizontal resolution capability. 5-7 = Not assigned. 8 = No maximum airspeed data available. 9 = Airspeed is ≤75 kts. 10 = Airspeed is >75 kts and ≤150 kts. 11 = Airspeed is >150 kts and ≤300 kts. 12 = Airspeed is >300 kts and ≤600 kts. 13 = Airspeed is >600 kts and ≤1200 kts. 14 = Airspeed is >1200 kts. 15 = Not assigned.																					
RL		1	9	X	Command, sent in UF=0, 16; solicits DF=0 reply if Zero and DF=16 reply if One (only if transponder is associated with Airborne Collision Avoidance System [ACAS] equipment). Otherwise, in UF=0, Zero solicits DF=0 reply and One solicits no reply. In UF=16, Zero solicits DF=16 reply and One solicits no reply.																					
RR		5	9-13	X	Contains length and content of interrogator requested reply. RR is part of surveillance and Comm-A interrogations UF=4, 5, 20, 21.																					
					<table border="1"> <thead> <tr> <th>RR CODE</th> <th>REPLY LENGTH</th> <th>MB CONTENT</th> </tr> </thead> <tbody> <tr> <td>0-15</td> <td>Short</td> <td>N/A</td> </tr> <tr> <td>16</td> <td>Long</td> <td>Air initiated Comm-B</td> </tr> <tr> <td>17</td> <td>Long</td> <td>Data link capability</td> </tr> <tr> <td>18</td> <td>Long</td> <td>Aircraft Identification</td> </tr> <tr> <td>19</td> <td>Long</td> <td>Resolution Advisories</td> </tr> <tr> <td>20-31</td> <td>Long</td> <td>Not Assigned</td> </tr> </tbody> </table> <p>NOTE: If first bit of RR code is One, decimal equivalent of last four bits of RR code designates code for BDS1 in reply (ground initiated). BDS2 is assumed to be Zero if not specified by DI=7 and RRS.</p>	RR CODE	REPLY LENGTH	MB CONTENT	0-15	Short	N/A	16	Long	Air initiated Comm-B	17	Long	Data link capability	18	Long	Aircraft Identification	19	Long	Resolution Advisories	20-31	Long	Not Assigned
RR CODE	REPLY LENGTH	MB CONTENT																								
0-15	Short	N/A																								
16	Long	Air initiated Comm-B																								
17	Long	Data link capability																								
18	Long	Aircraft Identification																								
19	Long	Resolution Advisories																								
20-31	Long	Not Assigned																								

Overview of Format Definitions (cont)
Table 3

FIELD	SUB FIELD	NO. OF BITS	BITS POSITION	FORMATS UP DOWN	CONTENT
SD		16	17-32	X	Contains control codes, as specified by the DI field affecting transponder protocol and is part of surveillance and Comm-A interrogations UF=4, 5, 20, 21.
	IIS	4	17-20	X	Interrogator Identifier subfield contains the self-identification code of the interrogator and is numerically identical to the II code transmitted by the interrogator in Mode S Only All Calls. IIS codes are 0 through 15; IIS=0 is not a valid interrogator identifier for multisite purposes. IIS is sent only when DI=0, 1 or 7.
	LOS	1	26	X	Lockout subfield, if set to One, initiates a multisite All Call lockout to Mode S Only All Calls (UF=11) from the Interrogator indicated in IIS of the interrogation. If LOS is set to Zero, no change in lockout state is commanded. LOS is sent only if DI=1 or 7.
	LSS	1	23	X	Lockout surveillance subfield, if set to One, shall signify a multisite lockout command from the interrogator indicated in SIS. LSS set to zero shall be used to signify that no change in lockout state is commanded.
	MBS	2	21-22	X	Multisite Comm-B subfield, sent when DI=1, is assigned the following codes: 0 = No Comm-B action. 1 = Comm-B reservation. 2 = Comm-B closeout.
	MES	3	23-25	X	Multisite ELM subfield, sent when DI=1, contains reservation and closeout commands for ELM as follows: 0 = No ELM action. 1 = Comm-C reservation. 2 = Comm-C closeout. 3 = Comm-D reservation. 4 = Comm-D closeout. 5 = Comm-C reservation and Comm-D closeout. 6 = Comm-C closeout and Comm-D reservation. 7 = Comm-C and Comm-D closeouts.

Overview of Format Definitions (cont)
Table 3

FIELD	SUB FIELD	NO. OF BITS	BITS POSITION	FORMATS UP DOWN	CONTENT
SD	RCS	3	24-26	X	Rate control subfield shall control the squitter rate of the transponder when it is reporting the surface format. The codes are: 0 = No squitter rate command 1 = Report high surface squitter rate for 60 seconds 2 = Report low surface squitter rate for 60 seconds 3 = Suppress all surface squitters for 60 seconds 4 = Suppress all surface squitters for 120 seconds 5-7 Not assigned
	RRS	4	21-24	X	Reply Request subfield, sent when DI=7, contains coding corresponding to the requested BDS2 code.
	RRS	4	24-27	X	Reply Request subfield, sent when DI=3, contains coding corresponding to the requested BDS2 code.
	RSS	2	27-28	X	Reservation Status subfield, sent when DI=1, requests transponder to report reservation status in the UM field. The codes are: 0 = No request. 1 = Report Comm-B reservation status. 2 = Report Comm-C reservation status. 3 = Report Comm-D reservation status.
	SAS	2	27-28	X	Surface Antenna Subfield, shall control the diversity antenna that is used for the acquisition and extended squitters when the aircraft is reporting the surface format. The codes are: 0 = No antenna command, use the top antenna 1 = Alternate top and bottom antennas for 120 seconds 2 = Use bottom antenna for 120 seconds 3 = Return to the default
	SIS	6	17-22	X	Surveillance Identifier Subfield, shall contain an assigned SI code of the interrogator.

Overview of Format Definitions (cont)
Table 3

FIELD	SUB FIELD	NO. OF BITS	BITS POSITION	FORMATS UP DOWN	CONTENT
SD	TCS	3	21-23	X	Type Control Subfield, shall control the position type reported by the transponder. The codes are: 0 = No position type command 1 = Use surface position type for the next 15 seconds 2 = Use surface position type for the next 60 seconds 3 = Cancel surface type command 4-7 = Not assigned.
	TMS	4	29-32	X	Tactical Message subfield, sent when DI=1 or 7, contains coding for linking the Comm-A message segments. The codes are: 0 = No Action. 1 = Unlinked, Priority. 2 = Unlinked, Acknowledge. 3 = Unlinked, Priority, Acknowledge. 4 = Linked 1st Segment, Single ADS. 5 = Linked 1st Segment, Single ADS Priority. 6 = Linked 1st Segment, Single ADS Acknowledge. 7 = Linked 1st Segment, Single ADS, Priority, Acknowledge. 8 = Linked 1st Segment, Multiple ADS. 9 = Linked 1st Segment, Multiple ADS, Priority. 10 = Linked 1st Segment, Multiple ADS, Acknowledge. 11 = Linked 1st Segment, Multiple ADS, Priority, Acknowledge. 12 = Second Segment. 13 = Third Segment. 14 = Final Segment. 15 = Not Assigned.

Overview of Format Definitions (cont)
Table 3

FIELD	SUB FIELD	NO. OF BITS	BITS POSITION	FORMATS UP DOWN	CONTENT
SL		3	9-11	X	Reports the current operating sensitivity level of the TCAS unit and is a part of air-air surveillance replies, DF=0, 16. The codes are: 0 = No TCAS sensitivity level reported. 1 = TCAS operates at sensitivity level 1. 2 = TCAS operates at sensitivity level 2. 3 = TCAS operates at sensitivity level 3. 4 = TCAS operates at sensitivity level 4. 5 = TCAS operates at sensitivity level 5. 6 = TCAS operates at sensitivity level 6. 7 = TCAS operates at sensitivity level 7. NOTE: The SL field has no meaning for aircraft with RI=0 (no on-board capability to generate resolution, advisories).
UF		5	1-5	X	The first field in all uplink formats is the transmission descriptor in all interrogations.
UM		6	14-19	X	Contains transponder status readouts in replies DF=4, 5, 20, 21.
	IDS	2	18-19	X	Identifier Designator subfield reports the type of reservation made by the interrogator identified in IIS and corresponds with the RSS subfield of SD. Assigned coding is: 0 = No information available. 1 = Comm-B reservation active. 2 = Comm-C reservation active. 3 = Comm-D reservation active.
	IIS	4	14-17	X	Interrogator Identifier subfield reports the identity of the interrogator that has made a multisite reservation.
VS		1	6	X	Indicates aircraft is airborne when Zero or aircraft is on the ground when One. VS is a part of DF=0, 16.

Overview of Format Definitions (cont)
Table 3

				B6	0	0	1	1
				B5	0	1	0	1
B4	B3	B2	B1					
0	0	0	0			P	SP	0
0	0	0	1		A	Q		1
0	0	1	0		B	R		2
0	0	1	1		C	S		3
0	1	0	0		D	T		4
0	1	0	1		E	U		5
0	1	1	0		F	V		6
0	1	1	1		G	W		7
1	0	0	0		H	X		8
1	0	0	1		I	Y		9
1	0	1	0		J	Z		
1	0	1	1		K			
1	1	0	0		L			
1	1	0	1		M			
1	1	1	0		N			
1	1	1	1		O			
SP=SPACE code								

6-Bit Character Set for AIS Subfield
Table 4

SRS OR TAS SUBFIELD VALUE		NUMBER OF SEGMENTS
OCTAL	HEXADECIMAL	
100000	8000	1
140000	C000	2
160000	E000	3
170000	F000	4
174000	F800	5
176000	FC00	6
177000	FE00	7
177400	FF00	8
177600	FF80	9
177700	FFC0	10
177740	FFE0	11
177760	FFF0	12
177770	FFF8	13
177774	FFFC	14
177776	FFFE	15
177777	FFFF	16

Valid Values for SRS and TAS Subfields
Table 5

BINARY	OCTAL	DECIMAL	HEXADECIMAL
000	0	0	0
001	1	1	1
010	2	2	2
011	3	3	3
100	4	4	4
101	5	5	5
110	6	6	6
111	7	7	7
1000	10	8	8
1001	11	9	9
1010	12	10	A
1011	13	11	B
1100	14	12	C
1101	15	13	D
1110	16	14	E
1111	17	15	F
10000	20	16	10

Number Systems Conversion
Table 6

UF#	FIELDS							
0	VS(b)	CC(b)	SL(d)	RI(d)			AC(h&o)	AA(h&o)
4	FS(d)	DR(d)	UM(h)	IDS(d)	IIS(d)		AC(h&o)	AA(h&o)
5	FS(d)	DR(d)	UM(h)	IDS(d)	IIS(d)		ID(h&o)	AA(h&o)
11	CA(d)	PI(h)						AA(h&o)
16	VS(b)		SL(d)	RI(d)	MV(h)		AC(h&o)	AA(h&o)
20	FS(d)	DR(d)	UM(h)	IDS(d)	IIS(d)	MB(h)	AC(h&o)	AA(h&o)
21	FS(d)	DR(d)	UM(h)	IDS(d)	IIS(d)	MB(h)	ID(h&o)	AA(h&o)
24	KE(b)	ND(d)		IDS(d)	IIS(d)			AA(h&o)
	h=hex b=binary d=decimal							

Mode S UF Fields Numeric Units
Table 7

APPENDIX J - STANDARD ACCESSORIES

1. AUXILIARY EQUIPMENT

Refer to Appendix J, Figure 1.

ITEM	DESCRIPTION	ITEM	DESCRIPTION
● DC Power Supply	Used to power the Test Set.	● 72 in. Coaxial Cable	Used to connect the Test Set to the UUT.
● Antenna	RF antenna used with Test Set when power accuracy is most critical.	● 5 A Fuse	Spare Fuse
● Breakout Box	Provides means of accessing individual user interfaces via standard connectors	● Power Cord (US Only)	Used to connect AC power from an external AC power source to AC PWR Connector.
● Antenna Shield	Used with Antenna Clamp Assembly to cover UUT Antenna not being tested.	● Power Cord (European)	Used to connect AC power from an external AC power source to AC PWR Connector.
● 12 in. Coaxial Cable	Used to connect Test Set ANT Connector to Directional Antenna ANT Connector.		



Auxiliary Equipment
Figure 1

2. ANTENNA SHIELD PROCEDURE

Refer to Appendix J, Figure 2.

STEP	PROCEDURE	STEP	PROCEDURE
1.	Position Antenna Clamp Assembly inside the slot in the Antenna Shield Plate, aligning captive screws into the respective screw holes.	3.	Cover UUT Antenna with Antenna Shield. Loosen Thumbscrews if necessary. NOTE: It may be necessary to remove UUT Antenna Guard if access to UUT Antenna is restricted.
2.	Tighten captive screws.	4.	Secure Antenna Shield by tightening thumbscrews.

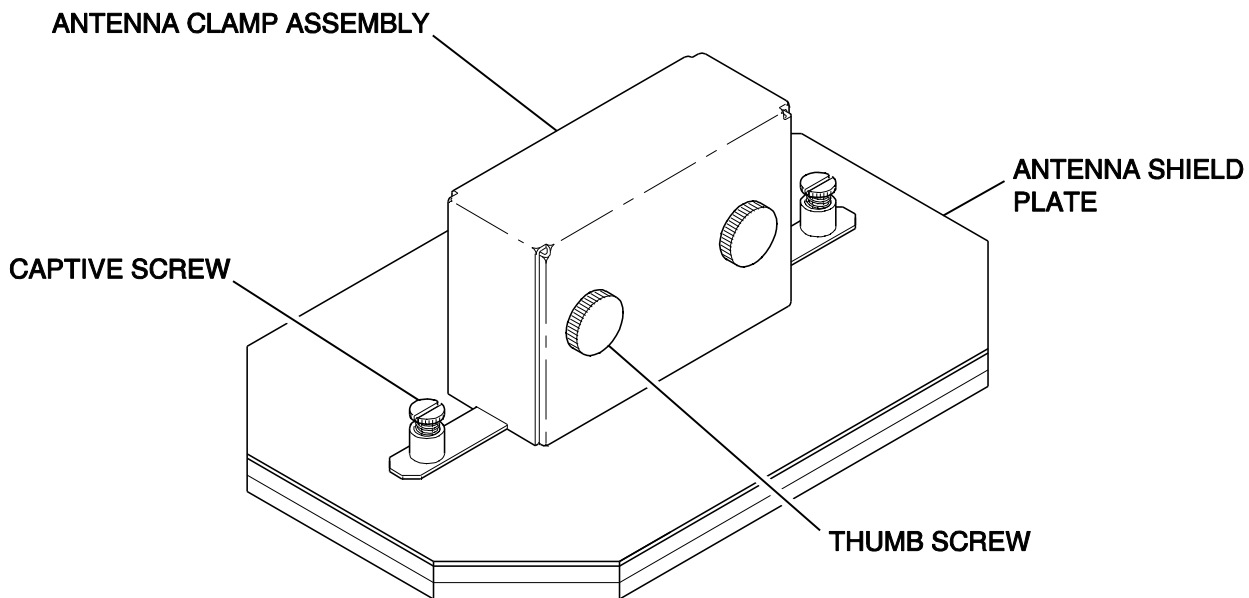

Antenna Shield
Figure 2

8107007

3. ANTENNA COUPLER PROCEDURE

Refer to Appendix J, Figure 3.

STEP	PROCEDURE
1.	Connect Antenna Coupler to Aircraft Antenna. <ul style="list-style-type: none">Place Coupler over the antenna, guiding antenna into the slot on the bottom of the coupler.Push Coupler firmly against the aircraft skin until the black rubber gasket on the rim of the coupler is completely depressed tightly against the aircraft.Lock coupler into place by pushing white lever on the side of the coupler into a down and locked position.

STEP	PROCEDURE
	NOTE: Coupler must be tightly pressed and locked in place for Test Set to function correctly. Coupler will lock into place when the black rubber gasket is not completely depressed against the aircraft, but the Test Set will not measure functions accurately.
2.	Connect UUT to Test Set RF I/O Connector via coaxial cable. CAUTION: TO PREVENT DAMAGE TO TEST SET, DO NOT CONNECT UUT TO TEST SET ANT CONNECTOR.



Antenna Coupler
Figure 3

THIS PAGE INTENTIONALLY LEFT BLANK.

APPENDIX K - TARGET ACQUISITION TIME PROBABILITY TABLE

The following table shows the probability of target acquisition time increasing by more than a specified time (in addition to the normal two to three sec). The table indicates, for example, there is a 10% probability the target acquisition time increases by more than ten sec.

NOTE: The table only applies when testing one UUT Antenna. Other UUT Antennas are shielded, disabled or out of the line-of-sight path with the IFR 6000 TCAS.

INCREASE IN TARGET ACQUISITION TIME	PROBABILITY PERCENTAGE
>3 sec	91%
>4 sec	76%
>5 sec	59%
>6 sec	44%
>7 sec	31%
>8 sec	22%
>9 sec	15%
>10 sec	10%
>11 sec	7%
>12 sec	4%
>13 sec	3%
>14 sec	2%
>15 sec	1%
>16 sec	0.7%
>17 sec	0.4%
>18 sec	0.3%
>19 sec	0.2%
>20 sec	0.1%

Target Acquisition Time Probability
Table 1

THIS PAGE INTENTIONALLY LEFT BLANK.

INDEX

Abbreviations	App D	USB DEVICE Connector	App E, p 2
AC Power Requirements	1-2-1, p 2	USB HOST Connector	App E, p 2
ADS-B	1-2-4, p 31	Test Set	
ADS-B GEN	1-1-2, p 7	I/O Connectors	App A, p 1
	1-2-4, p 63	REMOTE Connector	App A, p 2
	1-2-4, p 109	Controls, Connectors and Indicators	1-2-2, p 1
ADS-B GEN Data	1-2-4, p 112	DME	1-2-4, p 124
ADS-B/GICB	1-1-2, p 8	DME Setup	1-2-4, p 125
ADS-B/GICB/UAT MAIN	1-2-4, p 34	DME Setup Antenna	1-1-2, p 9
ADS-B MON	1-1-2, p 6	DME Setup Direct Connect	1-1-2, p 10
	1-2-4, p 34	DME Testing	1-1-2, p 11
ADS-B Setup	1-2-4, p 32	External Cleaning	1-2-1, p 3
Advisory Circular	1-1-2, p 9	Factory/Power Up Presets	App C
	1-2-4, p 57	FIS-B GEN	1-2-4, p 103
ALTITUDE ENCODER Connector		Functional Capabilities	1-1-1, p 1
Altitude Encoder Test	1-2-4, p 28	General Description and Capabilities	1-1-1, p 1
Pin-Out Table	App E, p 3	General Operation	1-2-1, p 1
Antenna Coupler		General Setup	1-1-2, p 2
Setup and Testing	1-1-2, p 5	GICB General	1-2-4, p 77
	1-2-4, p 29	GICB Mode	1-2-4, p 77
Antenna, Direct Connect		GPS Status	1-2-4, p 123
Description	1-1-2, p 4	Grounding Power Cord	1-2-1, p 1
Setup and Testing	1-1-2, p 4	Installation	1-2-1, p 1
	1-2-4, p 29	I/O Connectors	App A, p 1
Antenna, Directional		Metric/British Conversion Table	App B
Description	1-2-4, p 153	Mode S Address Blocks	
Setup and Testing	1-1-2, p 2	Product Specific List	App G
Antenna Shield Procedure	App J, p 2	Complete List	App H
Auto Test	1-2-4, p 8	Operating Procedures	1-2-4, p 1
AUX IN Connector Pin-Out Table	App E, p 4	Operating Safety	1-2-1, p 1
AUX OUT Connectors Pin-Out Table	App E, p 6	Operation	1-2-1, p 1
Battery		Over the Air Ground Test	1-2-4, p 30
Charging	1-2-1, p 1	Over the Air Simulated Altitude Test	1-2-4, p 30
Operation	1-2-1, p 1	Performance Evaluation	
Recharging	1-2-1, p 2	Calibration	1-2-3, p 2
Breakout Box		General	1-2-3, p 1
Connectors	App E	Manual Self-Test	1-2-3, p 2
Operation	1-2-4, p 157	RS-232 Self-Test	1-2-3, p 2
Complying with Instructions	1-2-1, p 1	Self-Test	1-2-3, p 1
Configurations, Transponder		Quick Start	1-1-2, p 1
Description	1-2-4, p 2		
Table	App F		
Connector Pin-Out Tables			
Breakout Box			
ALTITUDE ENCODER Connector	App E, p 3		
AUX IN Connector	App E, p 4		
AUX OUT Connector	App E, p 6		
REMOTE Connector	App E, p 7		
RS-232 Connector	App E, p 5		

Regulatory Responsibilities	1-1-1, p 2	Data	1-2-4, p 108
REMOTE Connector Pin-Out Table		UATGeneral	1-2-4, p 102
Test Set	App A, p 2	UATSetup	1-2-4, p 102
Breakout Box	App E, p 7	USB DEVICE Connector	App E, p 2
Repacking Procedure	1-4-1, p 1	USB HOST Connector Pin-Out Table	App E, p 2
RS-232 Connector Pin-Out Table	App E, p 5		
		XPDR	
Safety Precautions	1-2-1, p 1	Altitude Encoder	1-2-4, p 28
Self-Test	1-2-3, p 1	Auto Test	1-2-4, p 8
Shipping		Configurations	1-2-4, p 2
Information	1-4-1, p 1	Description	1-2-4, p 1
Repacking Procedure	1-4-1, p 1	Direct Connect Procedure	1-1-2, p 4
Signal Formats	App I		1-2-4, p 29
Specifications	1-3-1, p 1	Antenna Coupler Connect Procedure	
DME Mode Signal Generator	1-3-1, p 1		1-1-2, p 5
UUT Measurements	1-3-1, p 3		1-2-4, p 29
Miscellaneous	1-3-1, p 14	Over The Air Tests	1-2-4, p 30
Supplemental Information	1-3-1, p 16	Setup	1-2-4, p 3
TCAS Mode Signal Generator	1-3-1, p 10	Setup Antenna	1-1-2, p 2
UUT Measurements	1-3-1, p 13	Test List	1-2-4, p 10
Transponder Mode Signal Generator	1-3-1, p 4	Testing	1-1-2, p 5
UUT Measurements	1-3-1, p 6		
Standard Accessories	App J		
Start-Up	1-2-4, p 2		
Storage	1-5-1, p 1		
Target Acquisition Time	App K		
Test List	1-2-4, p 10		
TCAS Mode	1-2-4, p.128		
ATCRBS	1-2-4, p 144		
Broadcast Monitor	1-2-4, p 142		
Description	1-2-4, p 128		
Monitor Screens	1-2-4, p 140		
Operation Concept	1-2-4, p 128		
Recommended Test Procedure	1-2-4, p 147		
Screen	1-2-4, p 135		
Setup	1-2-4, p 131		
Setup Antenna	1-1-2, p 11		
Setup Scenario Data Screen	1-2-4, p 138		
Surveillance Monitor	1-2-4, p 140		
Testing	1-1-2, p 12		
	1-2-4, p 131		
TIS Mode			
General description	1-2-4, p 149		
Mode	1-2-4, p 149		
Setup	1-2-4, p 149		
Setup Antenna	1-1-2, p 13		
Setup Direct Connect	1-1-2, p 14		
Testing	1-1-2, p 15		
TIS-B Mode			
General description	1-2-4, p 107		

SAFETY FIRST: TO ALL SERVICE PERSONNEL

REFER ALL SERVICING OF UNIT TO QUALIFIED TECHNICAL PERSONNEL.

WARNING: USING THIS EQUIPMENT IN A MANNER NOT SPECIFIED BY THE ACCOMPANYING DOCUMENTATION MAY IMPAIR THE SAFETY PROTECTION PROVIDED BY THE EQUIPMENT.

CASE, COVER OR PANEL REMOVAL

Opening the Case Assembly exposes the technician to electrical hazards that can result in electrical shock or equipment damage.

SAFETY IDENTIFICATION IN TECHNICAL MANUAL

This manual uses the following terms to draw attention to possible safety hazards, that may exist when operating or servicing this equipment.

CAUTION: THIS TERM IDENTIFIES CONDITIONS OR ACTIVITIES THAT, IF IGNORED, CAN RESULT IN EQUIPMENT OR PROPERTY DAMAGE (E.G., FIRE).

WARNING: THIS TERM IDENTIFIES CONDITIONS OR ACTIVITIES THAT, IF IGNORED, CAN RESULT IN PERSONAL INJURY OR DEATH.

SAFETY SYMBOLS IN MANUALS AND ON UNITS



CAUTION: Refer to accompanying documents. (This symbol refers to specific CAUTIONS represented on the unit and clarified in the text.)



AC OR DC TERMINAL: Terminal that may supply or be supplied with ac or dc voltage.



DC TERMINAL: Terminal that may supply or be supplied with dc voltage.



AC TERMINAL: Terminal that may supply or be supplied with ac or alternating voltage.

EQUIPMENT GROUNDING PRECAUTION

Improper grounding of equipment can result in electrical shock.

USE OF PROBES

Check specifications for the maximum voltage, current and power ratings of any connector on the Test Set before connecting it with a probe from a terminal device. Be sure the terminal device performs within these specifications before using it for measurement, to prevent electrical shock or damage to the equipment.

POWER CORDS

Power cords must not be frayed, broken nor expose bare wiring when operating this equipment.

USE RECOMMENDED FUSES ONLY

Use only fuses specifically recommended for the equipment at the specified current and voltage ratings.

WARNING: THE IFR 6000 USES A LITHIUM-ION BATTERY PACK. THE FOLLOWING WARNINGS CONCERNING LITHIUM-ION BATTERIES MUST BE HEDED:

- **DO NOT RECHARGE OUTSIDE THE IFR 6000.**
- **DO NOT CRUSH, INCINERATE OR DISPOSE OF IN NORMAL WASTE.**
- **DO NOT SHORT CIRCUIT OR FORCE DISCHARGE AS THIS MIGHT CAUSE THE BATTERY TO VENT, OVERHEAT OR EXPLODE.**

CAUTION: INTEGRATED CIRCUITS AND SOLID STATE DEVICES SUCH AS MOS FETS, ESPECIALLY CMOS TYPES, ARE SUSCEPTIBLE TO DAMAGE BY ELECTROSTATIC DISCHARGES RECEIVED FROM IMPROPER HANDLING, THE USE OF UNGROUNDED TOOLS AND IMPROPER STORAGE AND PACKAGING. ANY MAINTENANCE TO THIS UNIT MUST BE PERFORMED WITH THE FOLLOWING PRECAUTIONS:

- BEFORE USE IN A CIRCUIT, KEEP ALL LEADS SHORTED TOGETHER EITHER BY THE USE OF VENDOR-SUPPLIED SHORTING SPRINGS OR BY INSERTING LEADS INTO A CONDUCTIVE MATERIAL.
- WHEN REMOVING DEVICES FROM THEIR CONTAINERS, GROUND THE HAND BEING USED WITH A CONDUCTIVE WRISTBAND.
- TIPS OF SOLDERING IRONS AND/OR ANY TOOLS USED MUST BE GROUNDED.
- DEVICES MUST NEVER BE INSERTED INTO NOR REMOVED FROM CIRCUITS WITH POWER ON.
- PC BOARDS, WHEN TAKEN OUT OF THE SET, MUST BE LAID ON A GROUNDED CONDUCTIVE MAT OR STORED IN A CONDUCTIVE STORAGE BAG. REMOVE ANY BUILT-IN POWER SOURCE, SUCH AS A BATTERY, BEFORE LAYING PC BOARDS ON A CONDUCTIVE MAT OR STORING IN A CONDUCTIVE BAG.
- PC BOARDS, IF BEING SHIPPED TO THE FACTORY FOR REPAIR, MUST BE PACKAGED IN A CONDUCTIVE BAG AND PLACED IN A WELL-CUSHIONED SHIPPING CONTAINER.

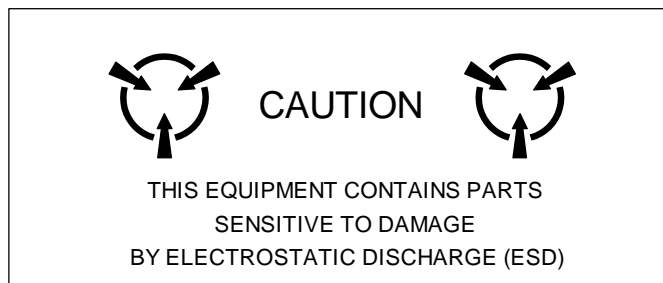

CAUTION: SIGNAL GENERATORS CAN BE A SOURCE OF ELECTROMAGNETIC INTERFERENCE (EMI) TO COMMUNICATION RECEIVERS. SOME TRANSMITTED SIGNALS CAN CAUSE DISRUPTION AND INTERFERENCE TO COMMUNICATION SERVICES OUT TO A DISTANCE OF SEVERAL MILES. USERS OF THIS EQUIPMENT SHOULD SCRUTINIZE ANY OPERATION THAT RESULTS IN RADIATION OF A SIGNAL (DIRECTLY OR INDIRECTLY) AND ENSURE COMPLIANCE WITH INSTRUCTIONS IN FAA CIRCULAR AC 170-6C, DATED FEBRUARY 19, 1981.

FOR QUALIFIED SERVICE PERSONNEL ONLY

FUSE REPLACEMENT

Refer to Figure 1.

STEP	PROCEDURE
1.	Verify the IFR 6000 is OFF and not connected to AC power.
2.	Fully loosen two captive screws in the two lower bumpers and remove the bumpers.
3.	Fully loosen five captive screws and lift the Battery Cover from the Case Assembly.
4.	Replace fuse: 5 A, 32 Vdc, Type F (Mini Blade Fuse) (VIAVI PN: 5106-0000-057)
	CAUTION: FOR CONTINUOUS PROTECTION AGAINST FIRE, REPLACE ONLY WITH FUSES OF THE SPECIFIED VOLTAGE AND CURRENT RATINGS.
5.	Install the Battery Cover on the Case Assembly and tighten the five captive screws (8 in/lbs.).
6.	Install the two lower bumpers and tighten the two captive screws in each bumper (8 in/lbs.).

BATTERY REPLACEMENT

Refer to Figure 1.

STEP	PROCEDURE
1.	Verify the IFR 6000 is OFF and not connected to AC power.
2.	Fully loosen two captive screws in the two lower bumpers and remove the bumpers.
3.	Fully loosen five captive screws and lift the Battery Cover from the Case Assembly.
4.	Disconnect the wire harness connecting the battery to the Test Set and remove the battery.
5.	Install new battery and reconnect the wire harness.
6.	Install the Battery Cover on the Case Assembly and tighten the five captive screws (8 in/lbs.).
7.	Install the two lower bumpers and tighten the two captive screws in each bumper (8 in/lbs.).
	WARNING: DISPOSE OF OLD BATTERY ACCORDING TO LOCAL STANDARD SAFETY PROCEDURES.
	 CAUTION: REPLACE ONLY WITH THE BATTERY SPECIFIED BY VIAVI. DO NOT ATTEMPT TO INSTALL A NON-RECHARGEABLE BATTERY.

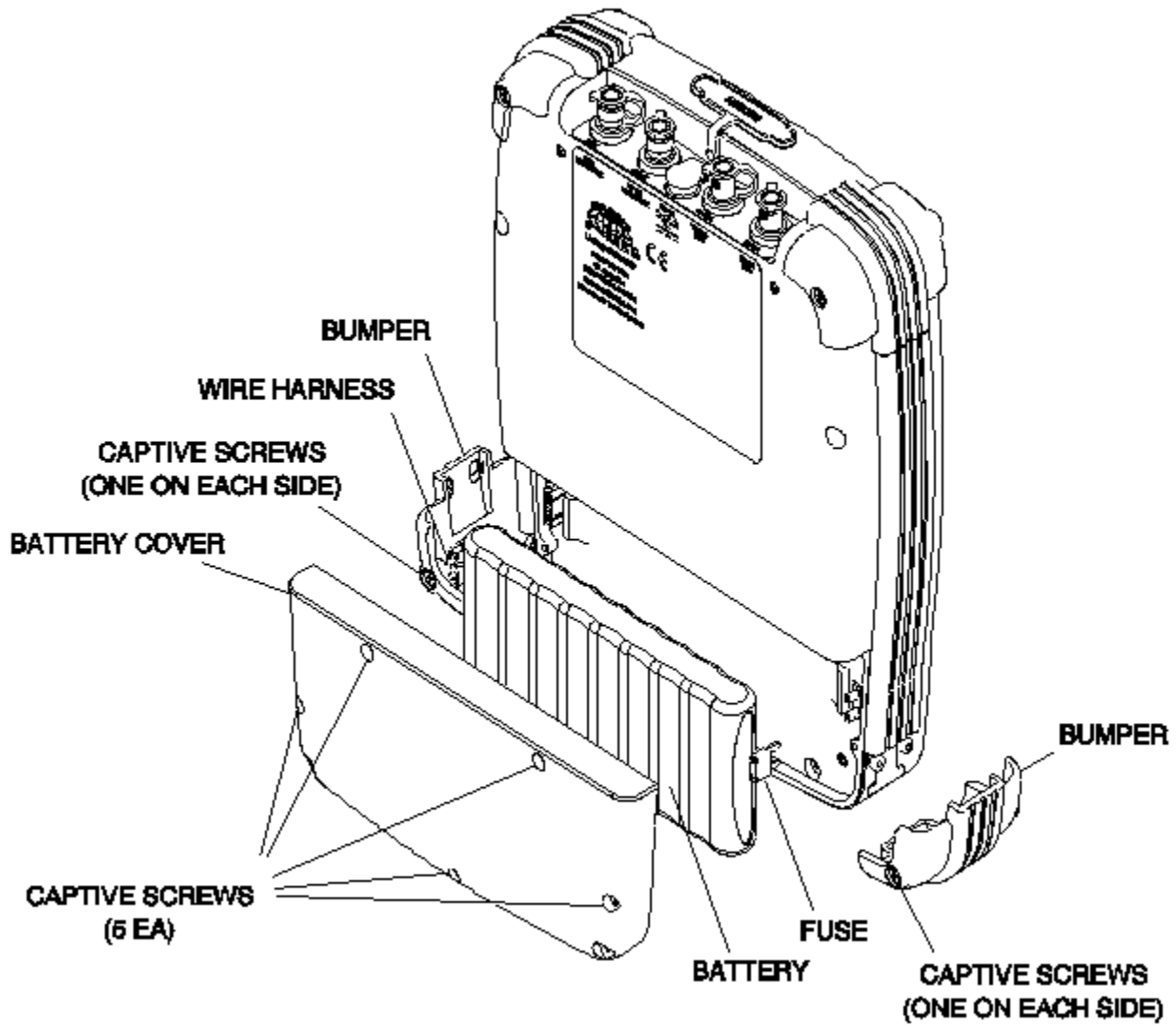

Battery and Fuse Replacement
Figure 1



IFR 6000 Operation Manual

6093 Rev. 503



December 2022

VIAVI Solutions

North America: 1.844.GO VIAVI / 1.844.468.4284

Latin America +52 55 5543 6644

EMEA +49 7121 862273

APAC +1 512 201 6534

All Other Regions: [viavisolutions.com/contacts](https://www.viavisolutions.com/contacts)